

Quickpull

This tool removes the cylinder from popular snap-in key-in-knob locksets.

Mfg # AYQP1 EZ # 001779

Replacement Blades: Mfg # AYQPBL EZ # 001778



20 "A" Pick

Made of heat treated stainless steel. Opens 137 standard tubular locks with mushroom pins and will pass all dead pins. Use supplied decoder once the lock is opened.

Mfg # AY20 EZ # 040001



The Dumping Block

Will dump and hold pins and springs from dozens of cores. Using the standard ejector pin (included), simply drive the pin stacks into the lower compartment. Constructed of hardcoat anodized aluminum.

Mfg # AYT3 EZ # 028449



The Capping Block

2 different tops for capping Best, Eagle, Arrow and Falcon. Punch and both tops store on unit to prevent loss. Constructed of hard anodized aircraft alloy and heat treated steel. 2 oz hammer suggested for use when capping.

Mfg # AYT2 EZ # 001785



Get-A-Grip

Features an extra long spiral and a hexagonal handle to help Get-A-Grip.

Mfg # AY30 EZ # 001797



Ignition Service Kits

G.M. 10-Cut. Specialized tension tools and rocker picks, release tool and decoder

Mfg # AYPS2 EZ # 031186



Tool for PS2. Allows picking for the "Top Hat" design.

Mfg # AYRPS12 EZ # 061319

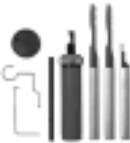

G.M. 10-Cut in dash. Bezel and face cap removal tool, specialized tension tools and rocker picks, release tool, decoder and jig

Mfg # AYPS3 EZ # 067683

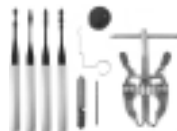

Ford 8-Cut. Bezel removal tool, jig and bits and tension tool.

Mfg # AYPS4 EZ # 074298

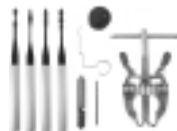

General Motors Lock Decoder

Decode all year GM sidebar locks without complete disassembly. Comes with easy to understand instructions.

Mfg # AY6 EZ # 001801



VATS Keys

Mfg #	EZ #	Mfg #	EZ #	Mfg #	EZ #
<i>Single Sided</i>		<i>Single Sided</i>		<i>Double Sided</i>	
AY201	073061	AY213	073073	AY779	073083
AY202	073062	AY214	073074	AY780	073084
AY203	073063	AY215	073075	AY781	073085
AY204	073064	<i>Double Sided</i>		AY782	073086
AY205	073065	AY772	073076	AY783	073087
AY206	073066	AY773	073077	AY784	073088
AY207	073067	AY774	073078	AY785	073089
AY208	073068	AY775	073079		
AY209	073069	AY776	073080		
AY210	073070	AY777	073081		
AY211	073071	AY778	073082		
AY212	073072				



Transponder Blanks

Mfg #	EZ #	Desc.
AYS72	074991	Ford
AYGMX367	080658	04 Prix
AYS86	078081	Ford Focus
AYY160SPT	078079	Chrysler
AYN102T	079343	Nissan
AYTOY43AT4	078078	Toyota
AYGMX320	080932	Cadillac CTS
AYGMT265	080933	Cadillac SRX



Automotive Blanks

Mfg #	EZ #	Desc.
AY16652	083114	Chevy Colorado
AY16653	083115	GMC Canyon



Security Multi Driver

Multi-bit screwdriver. Includes: Torx 9, 10, Hex 3/16, 5/32, 1/8, 9/64, Spanner 4, 6, 8, 10, Phillips #2 and Slotted 7/32.

Mfg # AY41 EZ # 077111



Retaining Ring Pliers

Features integral tips for working internal or external rings, cushioned grips and return spring.

Mfg # AY42 EZ # 077112



Multi Wrench

Takes the place of 8 SAE wrenches, includes 5/16, 3/8, 9/16, 5/8, 7/16, 1/2, 11/16 and 3/4. Constructed from chrome vanadium hardened steel.

Mfg # AY81 EZ # 077113



Plug Spinner

With the lock picked in the wrong direction, wind the spinner 1 1/2 turns, set the trigger, insert the blade into the plug, release the trigger, and the plug is now picked in the right direction.

Mfg # AY26 EZ # 001795



CapSaver Press

Uses brass strips to punch all caps as you set them. If you're capping just 10 cores a day, you save about 25¢ per core in material and labor.

Mfg # AYCAP5 EZ # 072711



CapSaver Strips

Mfg # AYCS50 50 pack EZ # 072843
Mfg # AYCS250 250 pack EZ # 072844



Broken Key Pullers

Made of top quality U.S. steel. The blades are locked in steel and fitted with a comfortable handle. Comes with 3 extractors: .040 spiral, saw tooth, and hook.

Mfg # AY27 EZ # 001796



Shim Holder

Holds curved shims firm, straight and without slippage to prevent cut fingers and make your job easier.

Mfg # AY18 EZ # 001790



Tubular Lock Saw

Rotary saw cuts away the shoulder over pins to allow them to be removed and lock opened. The pins remain intact so they can be measured to decode the lock.

Mfg # AY14 EZ # 001788



The Waffle Tray

Keeps pins, springs and plugs neatly separated in numbered pockets. Manufactured of coated metal, the tray is compact and stackable.

Mfg # AYWT1 EZ # 025792



Ace Key Decoder

Decodes "Ace" keys quickly, easily and accurately

Mfg # AY52 EZ # 001800



Vulcan Button Grabber

- Enters through closed doors • Will not scratch vehicle
- Rubber loop grabs and lifts even straight buttons
- Great for Mercedes
- No damage to linkage or wiring.

Mfg # AYCO2 EZ # 001766

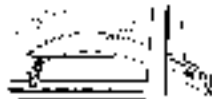

Cylinder Removal Tool

Cam action tool designed to remove stubborn mortise cylinders. This heavy-duty tool automatically adjusts from 5/16" to 1 1/2" in diameter. Heat treated and plated.

Mfg # AY16 EZ #001789



Pak-A-Punch Value Set

Includes Pak-A-Punch Model 3T plus all accessories for punching GM 10 & 6 cut, Chrysler double sided ('92-'97), Ford 8 & 10 cut, Plus some late model Jeep, Eagle and Mazda.

Mfg # AYPAK MS1 EZ # 066239



Complete Mortise Lock & Crosshole Installation System

Use to mortise both the lock pocket and the faceplate pocket. The M100 is self centering & accepts door thickness up to 2 1/2". Selective backset - 2 3/8", 2 1/2", 2 3/4".

Mfg # AYM100 EZ # 067033



Installation Jig For Simplex

Mfg # AYJ50 EZ # 066441

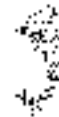

Bulls Eye Installation Tool For Cylindrical Locksets

- Machined tool with steel bushings
- Accommodates 1 1/2 & 2 1/8 crossbore
- 2 3/8 & 2 3/4 tool free backset adjustment

Mfg # AYBUL2 EZ # 077470



Side Plates For M-100

Manufactured of aircraft alloy & are hard anodized for longevity & durability. Use for drilling crossholes & mounting holes. Available in pairs only.

- | | | |
|---------------------|------------|-------------|
| Marks Mortise | Mfg # AYM2 | EZ # 067888 |
| Schlage 'L' Mortise | Mfg # AYM4 | EZ # 067035 |
| Simplex | Mfg # AYM5 | EZ # 067889 |
| Corbin/Russwin | Mfg # AYM6 | EZ # 067036 |
| Sargent | Mfg # AYM7 | EZ # 067890 |



I/C Multi Ejector Pin

4-pronged multi-punch can speed up many jobs.

Mfg # AYTBMF EZ # 001784



G-Pull

Pulls most GM trunk and deck plugs in seconds. Can also be used on some foreign cars, as well as some removable core padlocks, desk locks, etc.

Mfg # AYPGP1 EZ # 001767



Spinnakur

This new plug spinner has a virtually unbreakable spring (guaranteed for two full years). Left or right rotation. Fits in shirt pocket. Push button release.

Mfg # AYSP1 EZ # 001780





24/ST/70 and 28/ST/70

- Case hardened shackle extends around entire case allowing only 3/4" exposed.
- Lock Size – 2 3/4" • Shackle Diameter – 13/32"
- Shackle Opening – 3/4" wide; 3/4" deep
- 24/ST/70 - 4 pin tumbler, anti-pick mushroom pins
- 28/ST/70 - 4 pin tumbler, galvanized interior

Mfg.#	Description	EZ#
AU24ST70KA EE0113	Keyed Alike	025802
AU24ST70KA EE0249	Keyed Alike	040006
AU24ST70KD	Keyed Different	025803
<i>"Buffo"</i>		
AU28ST70KA 273	Keyed Alike	040007
AU28ST70KA 298	Keyed Alike	040008
AU28ST70CKD	Keyed Different	040009
AU24/41KBR	Key blank	025805
AU36 55KB	Key blank f/3655	060505

Rekeyable Diskus Padlocks - 24RK Series

- 5 pin rekeyable cylinder removes in seconds for quick changes in the field
- Thousands of key changes; keyed-alike and O bitted
- Deep laser-welded seam for high tensile strength

Mfg. #	EZ#
AU24RK70 OB	067687
AU24RK70KA RR0157	067855
AU24RK70KA RR0377	067856



24 RK Series

Diskus With Drill Protection

- Hardened chrome moly shackle
- Anti-pick mushroom pins
- Hardened steel drill plate protects keyway

Mfg. #	EZ#
AU2670 KA EE0113	075212



"Buffo"

24/ST/70

Rekeyable Padlocks

- Z-Bar feature for conversion from key-retaining to non-key-retaining
- New Pinning Window makes rekeying faster and easier than before
- Cylinders are interchangeable among the 83/45, 83/50 & 83/55

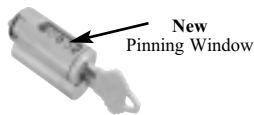

New Pinning Window

Mfg. #	Keyway	EZ#
AU8345 100	Yale 8	029849
AU8345 200	Kwikset	029850
AU8345 300	Schlage C	029847
AU8345 400	Corbin 60,59,A1, A2, B1, B2	030195
AU8345 700	Sargent LA - LC	030199
AU8345 800	Weiser-Falcon	030196
AU8345 900	Arrow	030197
AU8345 1000	Russwin D1-D4	030198
AU8345 3000	Schlage C-L	029848

Keyed 5/6 pin capacity

Mfg. #	Keyway	EZ#
AU8350 300	Schlage C	075207
AU8350 200	Kwikset	075208
AU8355 300	Schlage C	075209
AU8355 200	Kwikset	075210



2 1/4" body 2" body 1 3/4" body
3/8" shkl dia 3/8" shkl dia 3/8" shkl dia

Interchangeable Core Z-Bar System - 83IC45

- Exclusive "emergency security lock out" feature provides instant security restoration on the job site
- Accepts Arrow, Best, Falcon, KSP, Peaks, Eagle or Everest IC core cylinders for key control application systems (5,6,7 pin)

Mfg. # AU83IC45 1 EZ# 067848

Rekeyable Solid Steel

- Can key into the 24, 28 & 41 Series with Abus cylinder. Accepts American Lock 6-pin cylinders (PTC12 & PTC14)

Mfg. # AU3455RK AB EZ # 075211



83IC45

3455RK

110 Series Hasp

- "Center-lock" pin design resists being driven out at ends. • Seamless eye loop prevents prying
- Multiple link "Caterpillar" hasps provide the versatility to go around any corner or angle

200 Series Hasp

- Hidden mounting hardware, fixing plates and screws. Seamless eye loop prevents prying

Mfg.#	Description	EZ#
AU110/155C	6 1/4" Caterpillar Hasp (single hinged)	040011
AU110/195C	7 3/4" Caterpillar Hasp (double hinged)	040012
AU200/75C	3" Hasp	040017
AU200/115C	4 1/2" Hasp	040020



110

200



AR4500

Series 4500 Heavy Duty Deadlocking Latch

- Case Size: 7/8" X 6 13/16" • Bolt: 1/2" X 1" X 1/2" throw
- Faceplate: Flat standard

Mfg. #	B.S.	Hand	EZ #
AR4510 201 628	7/8"	LH	025828
AR4510 201 628	31/32"	LH	029590
AR4510 201 313	31/32"	LH	028154

AR4900



Series 4900 Deadlocking Latch

- Case Size: 7/8" X 5 13/16" • Bolt: 5/8" X 1" X 5/8" throw
- Faceplate: 1 Radius and 1 Flat included

Mfg. #	B.S.	Hand	EZ #
AR4900 35 201 628	1 1/8"	Non-Handed	029592
AR4900 35 201 313	1 1/8"	Non-Handed	028155
AR4900 45 201 628	1 1/2"	Non-Handed	035029

Series 1850 and 1850S Maximum Security Deadlock

The length of this bolt provides maximum security for any single leaf door or an installation where the gap between door and jamb is greater than it should be. Accepts standard mortise cylinder.

Case Size: 1" x 6" Bolt: 5/8" x 13/8" throw
 Five ply laminated stainless steel. Center ply has Alumina-Ceramic core.
 Material: Steel plated for corrosion resistance.



Faceplate for 1850
 Flat - 1 1/4" x 7 13/32"



Mfg. #	B.S.	EZ #
ARMS1850 110 628	7/8"	040023
ARMS1850 210 628	31/32"	040024
ARMS1850S110 628	7/8"	025812
ARMS1850S210 313	31/32"	040027
ARMS1850S210 628	31/32"	025813
ARMS1850S310 313	1 1/8"	040029
ARMS1850S310 628	1 1/8"	025814
ARMS1850S410 628	1 1/2"	025815

Faceplate for 1850S
 Flat - 1" x 6 7/8"

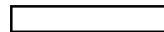

Lock Installation Kit Mfg# AR4418A EZ # 001013

For locksmiths or others who regularly install locks and latches in narrow stile aluminum and glass doors. Adams Rite provides a kit, complete with sturdy metal tool box. Basis of the installation kit is the mounting bridge and the positioning tool used to install it. The bridge is screwed into place, spanning the hollow door stile to provide a sturdy mounting surface for the lock, without the need to drill and tap the glass channel. The kit contains enough bridges, resilient washers and screws for 25 installations. It also includes a special 1 11/32" hole saw and hardened steel pilot plug for quick and perfectly aligned installation of MS4043 cylinder guards. Two cylinder guards, a spare hole-saw blade, armored strike, adhesive templates and miscellaneous spare parts are also furnished.



7100 Electric Strike

Case

Approx. 1" x 3 3/8" x 1 5/8" deep. Zinc-alum alloy.

Strike Lip

Basic 7100 strike has a lip of proper length for 1 3/4" thick door that closes flush with jamb edge.



Strike Opening

5/8" x 1 7/16" x 1/2" deep. Bolt retainer jaw stainless steel. Strike accepts bolt of any Adams Rite 4700 Series deadlatch or cylindrical latches.

Faceplate

According to application.



4603 RECTIFIER

Converts AC current to DC, installs in low voltage line between transformer and strike.

Mfg # AR4603 EZ # 001039

4605 TRANSFORMER

Converts 120VAC to 24VAC. Rated 40 volt-amp output assures plenty of power for strike release. Patented mounting bracket fits in knockout hole of standard junction boxes.

Mfg # AR4605 EZ # 001040



Mfg#	Faceplate	Voltage	Features	EZ #
AR7100 540 628	1 1/4" x 4 3/8" flat strike w/square corners	12 VDC / 24 VAC Int.	Fail Secure	061026
AR7101 540 628	1 1/4" x 4 3/8" radius strike w/rounded corners	12 VDC / 24 VAC Int.	Fail Secure	060916
AR7130 315 628	1 1/4" x 6 3/8" flat strike w/square corners	12 VDC Cont/Int	Fail Safe/Fail Secure	060917
AR7130 540 628	1 1/4" x 6 3/8" flat strike w/square corners	12 VDC / 24 VAC Int.	Fail Secure	060918
AR7140 315 628	1 1/4" x 4 3/8" flat strike w/square corners	12 VDC Cont/Int	Fail Safe/Fail Secure	060920
AR7140 310 628	1 1/4" x 4 3/8" flat strike w/square corners	12 VDC / 24 VAC Cont/Int	Fail Safe/Fail Secure	060248
AR7140 515 628	1 1/4" x 4 3/8" flat strike w/square corners	24 VDC Cont/Int	Fail Safe/Fail Secure	072277
AR7140 510 628	1 1/4" x 4 3/8" flat strike w/square corners	24 VDC Cont/Int	Fail Safe/Fail Secure	060247
AR7140 540 628	1 1/4" x 4 3/8" flat strike w/square corners	12 VDC/24 VAC Int.	Fail Secure	001053
AR7140 340 628	1 1/4" x 4 3/8" flat strike w/square corners	12 VAC Int.	Fail Secure	062038
AR7170 540 628	1 1/4" x 4 3/8" flat strike w/square corners	24 VAC Int	Fail Secure	001060
AR71R1 510 119	1 3/4" x 9" x 3/4" mounting plate/housing	24 VDC Cont/Int	Fail Safe/Fail Secure	072278



AR71R1

All strikes are field reversible fail safe / fail secure

Faceplates

Mfg #	Desc.	EZ #
AR24 0017 0220 313	Flat faceplate f/4710	000898
AR24 0017 0220 628	Flat faceplate f/4710	000897
AR24 0017 1220 313	Radius faceplate f/4710	000900
AR24 0017 1220 628	Radius faceplate f/4710	000899
AR24 0017 2220 628	LH bevel faceplate f/4710	000901
AR24 0017 3220 628	RH bevel faceplate f/4710	000903
AR24 0384 120 313	Radius faceplate f/1850S-050	000928
AR24 0384 120 628	Radius faceplate f/1850S-050	000927
AR24 0384 210 628	LH bevel faceplate f/1850S	000929
AR24 0384 310 628	RH bevel faceplate f/1850S	000933
AR24 0398 010 628	Large flat faceplate f/1850	000940
AR24 0687 01 313	Faceplate for 7140 Duro	065640



AR24 0017 1220 628

7310 Compact Strike

- Case: 1 1/8" x 3 3/8" x 1 1/8"
- Faceplate: 1 1/8" x 7 1/8"

12 Volt / Cont. or Int. / Fail Secure

Mfg # AR7310 310 628

EZ# 084087





4550 MS Lever

Specifically designed to fit any Adams Rite MS Deadbolt.

Mfg#	Fin.	EZ #
AR4550L313	Duro	062459
AR4550L628	Aluminum	062460



Meets ADA guidelines for easy accessibility

4565/4568 Latch Handles

Mfg#	Fin.	Hand	EZ#
AR4565 501 121	121(313)	LH	001023
AR4565 501 130	130(628)	LH	001022
AR4568 501 121	121(313)	LH	001027
AR4568 501 130	130(628)	LH	001016



AR4565



AR4568

Field Reversible
Includes Cam Plug Assembly

4590 Latch Paddles

Mfg#	Hand	EZ #
AR4590 02 00 313	Push to left	001034
AR4590 02 00 628	Push to left	001033



4580 cam disc included
Field reversible.

4591 Latch Paddles

Mfg#	Hand	EZ #
AR4591 02 00 313	LH or RHR	074885
AR4591 02 00 628	LH or RHR	074883
AR4591 04 00 313	RH or LHR	074886
AR4591 04 00 628	RH or LHR	074884



Series 8000 Exit Devices For Narrow Stile Glass Doors - U.L. Life-Safety Listed

Push bars are extruded anodized aluminum with black ABS end caps. Normal no-load actuation requires only 8 lbs. pressure anywhere along bar. At rest, bar projects 2 1/2" above door surface. Dogging provision is by key (furnished), requiring a single quarter turn in the end cap nearer the door nose. Handing can be reversed.

8400 Mortise Exit Device

Fits in the standard narrow stile cutout used for the M.S. deadlock. Four additional 1/4" holes for threaded blind fasteners complete the simple stile preparation. The all steel latch case has a white bronze bolt and deadlatching mechanism. Bolt throw is 3/8". Accepts any standard mortise cylinder (with A/R cam) from outside, if required. Minimum door stile depth required is backset plus .64 inch. Faceplate stocked flat – optional faceplates available. Standard strike furnished fits installations where 1 3/4" thick door closes flush with jamb.

Mfg#	Fin.	B.S.	Hand	EZ#
AR8410 27136 628	628	3/2"	RHR	025836
AR8410 37136 628	628	1 1/8"	RHR	025837

8800 Rim Mounted Exit Device

Patented starwheel bolt used to achieve a high level of security and performance by interlocking a strike mounted on the door frame. When door closes, the noseguard and starwheel bolt close around the strike, creating a solid interlock between door and frame.

Mfg#	Fin.	EZ#
AR8802 36	313	025836
AR8802ELD36 12	313 / Electric	025837



8099M Active Dummy Bar with Switch

The Active Dummy Bar has a clean, uncluttered look. Installs easily and quickly. Can be wired normally open or normally closed to operate maglock, alarm, etc. No latching mechanism.

Mfg# AR8099M628 EZ # 060921



Replacement Parts

MS1850S-050 Hookbolt Deadlock

Identical to the MS1850S, except the bolt is provided in a hook shape to resist the parting motion of sliding door and jamb. Accepts standard mortise cylinders with an AR cam.



Case Size: 1" x 6"
 Bolt: 5/8" x 1 3/8" x 13/16" throw
 Faceplate: 6 7/8" x 1" flat
 Strike: Order Separately
 Material: Steel, plated

Mfg#	B.S.	EZ #
ARMS1850S150 628	7/8"	025817
ARMS1850S250 628	31/32"	025818
ARMS1850S350 628	1 1/8"	025819
ARMS1850S450 628	1 1/2"	025820

AR4089 00 130 Exit Indicator

Provides unmistakable notification to building occupants of an exits "locked" or "open" condition. Word "LOCKED" appears in red letters and "OPEN" in black letters on white background when lock is actuated. Compatible with MS1850S.



Mfg # AR4089 00 130 EZ# 001004

MS+1890 Hookbolt Deadlock & Latch

Typical installation is a bank or store requiring three modes of door control: (1) Both lock and latch bolts retracted for unrestricted entry and exit during business hours; (2) Paddle operated latch for exit-only traffic just after closing, and (3) Maximum Security hookbolt for overnight lockup. Cylinders or thumbturns operate both lock and latch bolts.

Case Size: 1" x 7 3/8".
 Lock Bolt: 5/8" x 1 3/8" x 13/16" throw.
 Latch Bolt: 5/8" x 5/8" x 7/16" throw.
 Armor Faceplate: 6 7/8" x 1" flat.
 Armored Strike: Furnished flat.
 Finish: Clear satin anodized.



*Not compatible with electric strikes. May use with lever paddles

Mfg#	Hand	B.S.	EZ #
ARMS1890 2016 628	reversible	3/32"	025821
ARMS1890 3015 628	reversible	1 1/8"	043510

1000 Turns

Perpendicular drive spindle.
 AR1000 21 32 626 EZ# 025811



MS1847 Deadlock

For Narrow Stile Sliding Doors
 Case: 1/2" x 33/16" x 11/8".
 Bolt: Anti-lift/Adjustable.
 Pulls: See 4025.
 Turns: See Series 1000.
 Finish: US32D



Mfg # ARMS1847 630 EZ # 000971

4025 Cylinder Pulls

4025 has mounting holes spaced to allow clearance around 1847 lock mechanism.
 05-Schlage C kwy; 06-Weiser kwy



Mfg # AR4025 05 01 130 EZ# 000997
 Mfg # AR4025 06 01 130 EZ# 000998

Miscellaneous Parts

Mfg #	Desc	EZ #
AR29 0250 12DCC	Solenoid cont. duty 12DC	063530
ARMS4002 012	Armored strike for MS lk	000996
AR4101 01	Mounting clip - radius	001005
AR4104 02	Mounting clip - flat	001006
AR4104 03	Mounting clip - LH	001007
AR4104 04	Mounting clip - RH	001008
ARS232B8 9/32N 631	Set screw 7/8" b.s.	001047
ARS232C08 05 631	Set screw 3/32" b.s.	000993
ARS232C8 15/32 631	Set screw 1 1/8" b.s.	000970
ARS23355D08R04 628	Faceplate screw	000886
ARS235D08R313	Faceplate screw	040033



Mounting Clip



Cam Plug

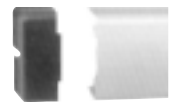

End Cap

For Lever Handles

Mfg #	Desc	EZ #
AR4580 501	Cam plug - LH	001029
AR31 0485	Spindle assy.	000955

For Exit Devices

Mfg #	Desc	EZ #
AR41 0801 01	Dogging Cap	035005
AR25 0480	Dogging Key (Plastic)	000986
AR29 0480	Dogging Key	000992
AR29 0481	New Style Dogging Key	065417
AR31 0265	Dogging assembly	067223
AR41 0801 08	End cap (8800)	028236





2 HR Composite Burglar & Fire Safes

- UL listed Group 2 combination lock
- 2 independent relocking devices with glass relock trigger
- 1 1/4" chrome-plated locking bolts • 2" thick door and 3" thick body
- 2 - 3 dead locking bolts to prevent entry into safe by removing hinges

Mfg. #	Inside (H x W x D)	Outside (H x W x D)	Cu. In.	Wt.	Shelf	EZ #
UMCBF1	12" x 11 1/2" x 12"	17 3/4" x 17 3/4" x 20 1/2"	1,656	210	1	070415
UMCBF2	21" x 13 1/2" x 13"	27" x 20" x 20 1/2"	3,686	325	1	070416
UMCBF3	27 1/4" x 13 1/2" x 15"	33" x 20" x 22 3/4"	5,518	365	2	070752
UMCBF4	27" x 21 3/4" x 21"	33 1/4" x 28" x 29"	12,191	575	2	073214
UMCBF5	35 1/2" x 21 3/4" x 20"	41 1/2" x 28" x 29"	15,620	685	2	073215
UMCBF6	54" x 21 3/4" x 21 1/4"	59 1/4" x 28" x 29"	26,393	830	2	073216

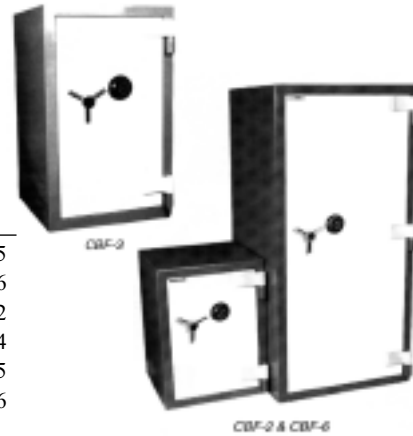

1 & 2 Hour Rated Fire Safes

1 Hour Rated Safes:

- Combination dial and high security key lock for dual security and/or day lock function
- "E" series have electronic locks only (no key lock)
- Equipped with sliding tray and/or adjustable shelf and non skid rubber feet

2 Hour Rated Safes:

- UL listed Group 2 combination lock and high security key lock for dual security and/or day lock function
- All 2 HR safes include some or all of the following: adjustable shelves and/or locking drawers
- Equipped with cast wheels for mobility

Mfg. #	Inside (H x W x D)	Outside (H x W x D)	Cu. In.	Wt.	Shelf/Tray/Drawer	EZ #
1 Hour Rated						
UMUS25	6" x 12" x 8 1/2"	11 3/4" x 15 1/4" x 12 1/2"	867	55	1 0 0	070405
UMUS25E	6" x 12" x 8 1/2"	11 3/4" x 15 1/4" x 12 1/2"	867	55	1 0 0	070406
UMUS25T	9 1/2" x 8 1/2" x 8 1/2"	15 1/2" x 11 1/2" x 12 1/2"	867	55	1 0 0	070407
UMUS25TE	9 1/2" x 8 1/2" x 8 1/2"	15 1/2" x 11 1/2" x 12 1/2"	867	55	1 0 0	070408
UMUS45	6 3/4" x 13 3/4" x 10 1/4"	14 1/2" x 18 3/4" x 15 1/2"	1,198	90	0 1 0	070409
UMUS45E	6 3/4" x 13 3/4" x 10 1/4"	14 1/2" x 18 3/4" x 15 1/2"	1,198	90	0 1 0	070410
UMUS65	14 3/4" x 13" x 12 1/4"	20 3/4" x 16" x 19"	2,720	120	0 1 0	083291
UMUS65E	14 3/4" x 13" x 12 1/4"	20 3/4" x 16" x 19"	2,720	120	0 1 0	083292
UMUS75	14 1/4" x 13 1/4" x 12"	21 1/4" x 18 3/4" x 17 3/4"	2,584	150	1 1 0	070411
UMUS75E*	14 1/4" x 13 1/4" x 12"	21 1/4" x 18 3/4" x 17 3/4"	2,584	150	1 1 0	070412
2 Hour Rated						
UMUS100	16 1/4" x 12 1/4" x 11 3/4"	28 1/4" x 19 1/4" x 18 1/4"	2,663	191	1 0 1	070413
UMUS190	19 1/4" x 16 1/4" x 13 1/4"	34 1/2" x 23 1/4" x 20"	5,329	286	1 0 1	070414

T = Tall E = Electronic Locks * = Electronic & key lock



Guest Safes

- Solid steel construction • Master override • Powered with 4 AA alkaline batteries
- Predrilled bolt holes for simple installation • Guest instruction card included

Mfg. #	Inside (H x W x D)	Outside (H x W x D)	Cu. In.	Wt.	EZ #
UMGS5E	9 1/4" x 13 3/4" x 8 1/2"	10 3/4" x 14" x 10 1/2"	1081	32	073404
UMGS5EC	9 1/4" x 13 3/4" x 8 1/2"	10 3/4" x 14" x 10 1/2"	1081	32	074343



Hide-A-Buck

- Solid steel construction • 4 Ceramic magnets to place within a safe • Holds up to three 1" thick bundles of cash

Mfg # UMHAB1 EZ # 074342 Size: 7" x 8 3/4" x 1" Wt: 11lbs





Home & Small Business Floor Safes

Business Deposit Safes

RD (Rotary Deposit): 4 mounting holes for extra secure installation. Drops through top, easily accomodates bank bags and large envelopes.

PD (Postal Deposit): 4 mounting holes for extra secure installation. Deposit bags can be dropped through front.

JO (Small Deposit): ACE II high security cam locks. 4 Pre-drilled mounting holes, slot opening above formed door.

Mfg. #	Inside (H x W x D)	Outside (H x W x D)	Cu. In.	Wt.	EZ #
UMJO400	5 5/8" x 5 5/8" x 10 3/4"	6" x 6" x 12"	325	27	076388
UMJO626 1	5 5/8" x 3 5/8" x 8"	6" x 4" x 10"	164	13	070398
UMJO626 2*	5 5/8" x 3 5/8" x 8"	6" x 4" x 10"	164	13	070399
UMJO626 2X*	9 5/8" x 5 5/8" x 10"	10" x 6" x 12"	541	26	070400
Premium Depositories					
UMRD2214	14" x 13 1/2" x 16 1/2"	22" x 14" x 19"	3,118	140	070401
UMRD2714	17" x 13 1/2" x 16 1/2"	27" x 14" x 19"	3,187	155	070402
UMPD2214	14" x 13 1/2" x 11 1/2"	22" x 14" x 14"	2,174	127	070403
UMPD2714	17" x 13 1/2" x 16 1/2"	27" x 14" x 19"	3,187	155	070404
Economy Depositories					
UMRD2014C	13" x 13 3/4" x 11"	20" x 14" x 14"	1,966	89	084108
UMRD2614C	19" x 13 3/4" x 11"	26" x 14" x 14"	2,874	115	084110
UMRD3214C	13" x 13 3/4" x 11"	33" x 14" x 14"	1,966	161	084112
UMPD2014C	13" x 13 3/4" x 11"	20" x 14" x 14"	1,966	89	084107
UMPD2614C	19" x 13 3/4" x 11"	26" x 14" x 14"	2,874	115	084109
UMPD3214C	13" x 13 3/4" x 11"	33" x 14" x 14"	1,966	161	084111

* = dual control key locks



Home & Small Business Floor Safes

QB Features: 1/2" A36 solid steel door, massive spring assisted gloss black hinges, 3/4" chrome plated locking bolts and full-length dead bar to prevent entry by removing hinges

S Features: Slotted door with baffle, 1/2" A36 solid steel lift-out door, 4" chrome locking bar, full-length dead bar for optimal pry resistance.

SO Features: 1/2" A36 solid steel direct drive lift-out door, third spring-loaded relocking device and full-length dead bar for optimal pry resistance.

Mfg. #	Inside (H x W x D)	Outside (H x W x D)	Cu. In.	Wt.	EZ #
UMQB1408	12" x 14 1/2" x 8"	12 3/8" x 14 7/8" x 11 1/4"	1392	87	070386
UMQB1412	12" x 14 1/2" x 12"	12 3/8" x 14 7/8" x 15 1/4"	2088	102	070387
UMQB1418	12" x 14 1/2" x 18"	12 3/8" x 14 7/8" x 21 1/4"	3132	120	070388
UMSO807	8 3/8" x 8 3/8" x 7"	8 3/4" x 8 3/4" x 10 1/4"	491	47	070389
UMSO812	8 3/8" x 8 3/8" x 12"	8 3/4" x 8 3/4" x 15 1/4"	842	59	070390
UMSO812S	8 3/8" x 8 3/8" x 12"	8 3/4" x 8 3/4" x 15 1/4"	842	59	070391
UMSO817	8 3/8" x 8 3/8" x 17"	8 3/4" x 8 3/4" x 20 1/4"	1192	70	070392
UMSO817S	8 3/8" x 8 3/8" x 17"	8 3/4" x 8 3/4" x 20 1/4"	1192	70	070393
UMS807	8 3/8" x 8 3/8" x 7"	8 3/4" x 8 3/4" x 10 1/4"	491	48	070394
UMS812	8 3/8" x 8 3/8" x 12"	8 3/4" x 8 3/4" x 15 1/4"	842	60	070395
UMS812S	8 3/8" x 8 3/8" x 12"	8 3/4" x 8 3/4" x 15 1/4"	842	60	070396
UMS817	8 3/8" x 8 3/8" x 17"	8 3/4" x 8 3/4" x 20 1/4"	1192	71	070397

S = Slotted door with baffle



QB 1408, QB 1418



SO 807, SO 812 & SO 817

Laptop Safes

- Big enough to lock away any laptop, small enough for home of office
- 12 gauge solid steel
- Two anchor holes in the back wall and four in the under-floor make it easy to mount

Mfg. #	Inside (H x W x D)	Outside (H x W x D)	Wt.	EZ #
UMLS816	6 5/8" x 15 5/8" x 16 3/4"	8" x 16" x 18"	36	077720
UMLS816IC	6 5/8" x 15 5/8" x 16 3/4"	8" x 16" x 18"	36	077721





Video Door Sentry Set

- Video and audio turn on when door calls in
- Simple 2-wire hook up, can replace existing doorbell
- Infrared, CCD camera for low light applications
- Wide angle CCD cameras
- Includes one MK-1GD master monitor and one PS-1820UL power supply:

Mfg # APMKS 1GD EZ # 084437



Video Senty Color Stations

- Door calls in with 4-tone chime, 30 sec.
- Hear and see door instantly.
- Night viewing up to 1' from camera
- Selective callin or All Call

Master Color Station

Mfg # APKB 3MRD EZ # 084439

Sub-Master Color Station

Mfg # APKB 3HRD EZ # 084440



Handsfree Color Intercom Kit

- VOX or Push-to-Talk operated communication
- Up to three inside stations, either audio only or audio video
- Selective calling and All Call between inside stations
- Large TALK button activates communication
- One or two color video door stations
- Hands-free Audio and Video monitoring

Mfg # APJBS 2AD EZ # 084438



Color Video Door Station

- Tilt color camera
- Instant on audio and image of door when call button pressed
- White LED illumination automatically turns on

Mfg # APKB DAR EZ # 084441



Power Supplies

Mfg#	Desc	EZ #
APSKK 620	6V DC	028974
APPT 1210N	12VAC for CCS	084448
APPS 2420UL	24V for C123	084442
APPS 1225UL	12VDC for LEF	084446

LE Sub Station

- Weather-resistant
- 3 1/2" x 4 3/4" • Surface mount

Mfg # APLE D EZ # 029253



LE Sub Station

- Weather-resistant
- 4 1/8" x 4 1/2" • Flush mount

Mfg # APLE DA EZ # 060491



Chime Com Set

- Open voice door answering with door release control
- Adjustable communication volume
- Automatically turns off
- Battery or DEC power supply

Mfg # APC 123LA EZ # 028808



Chime Com 2 Set

- Press-to-talk door answering with automatic shutt-off
- Second inside room station (separate power supply required)
- Backlit CALL button
- CHIME and VOICE volume controls

Mfg # APCCS 1A EZ # 084447



Open Voice Intercom

- Intermixable system with any number of master and subs to max. capacity
- Selective calling from any master with hands-free reply

Mfg#	Desc	EZ #
APLEF 3	3 call	084443
APLEF 5	5 call	084444
APLEF 10	10 call	084445

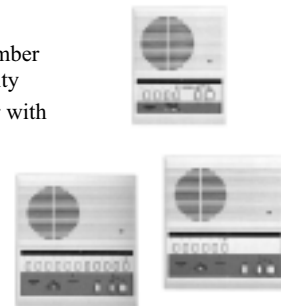

Access Sentry

- Single door open voice access control
- Adjustable transmit (front) & tone volumes
- Includes power supply

Mfg # APLEM1DLS EZ # 060492

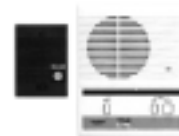



T2 Trilogy

- Standard keyway SC1, available in I/C model accepting 6 or 7 pin cores from Arrow, Best, Everest, Falcon, KSP, or Peaks
- Self contained fully programmable 12 digit metal keypad • Programmable access codes and functions
- Battery operated, uses 5 AA batteries • Low power audible alert
- Visual and audible entry indicators • Tamper resistant. • Key by-pass
- Rekeyable and accepts cylinders keyable to most key systems • Remote override.
- UL Listed fire rated • **DL2800 - 200 codes & 1000 event audit trail**
- Easy to install. Retrofits most cylindrical locksets and digital locks.



Finishes:

- 3 = polished brass
- 5 = antique brass
- 26 = polished chrome
- 26D = satin chrome

WP = Weatherized lock for extreme weather conditions outdoors

Trilogy Panic Exit Device Trim

Mfg # ALETDL51G26D V99 EZ # 077217

V99 = Von Duprin 98/99 Series

Lever Return Spring

Mfg # ALS6148 EZ # 077921

Mfg #	EZ#	DL2700, DL2800, DL3000 and PDL3000 Deadlatches
ALDL2700 26D	062860	2 3/8" - Mfg # ALS5980 26D EZ # 077903
ALDL2700 26	062859	2 3/4" - Mfg # ALP5849 26D EZ # 077904
ALDL2700 5	063512	
ALDL2700 3	062857	
ALDL2700 10B	085269	
ALDL2700WP 26D	068444	
ALDL2800 26D	071123	
ALDL2700IC 26D	065036	
ALDL2700ICWP 26D	068445	
ALDL2700IC 26	062863	
ALDL2800IC 26D	071124	

Trilogy Battery Pack

Mfg # ALS6061 EZ # 077922

Mfg # ALS6065 EZ # 078913

Adapter Kits For Exit Device Trim

Mfg # ALETBIC EZ # 077218 (Best IC)

Mfg # ALETS EZ # 077219 (Schlage)



T3 Trilogy All the features of the the T2 plus:

- 1600 event log
- Up to 150 scheduled events may be programmed
- 3,4,5 and 6 digit codes
- Print out event log and user code
- 300 user codes
- 1 time only schedules allow time zone lock



ALALIR1

Mfg #	EZ#	Mfg #	Description	EZ#
T3 Lever Lock		ALAL PCI	Cable with software	068181
ALDL3000 26D	068180	ALDTM2	Data Transfer Module	075808
ALDL3000WP 26D	070043	ALALIR1	Wireless printer	069442
T3 I/C Lever Lock		ALHW620	Tail-piece Lori cyl.	068449
ALDL3000IC 26D	068228	AL261	Current transfer	035044
ALDL3000WP IC26D	071206	ALHW580	Tail piece for Schlage	070538
ALDL3000IC3	074034	ALHW567	Outside Spacer	072791
		ALHW569	Inside Spacer	073798
		ALS6072	Spacer for 1 3/8" door	084873

IEI Accessories

Mfg #	Description	EZ#
IEPROX CARD II	25 pack prox cards	071136
IEPROX KEY FOB	Prox key HID FOB	069945

Trilogy Mortise Lock

- 40,000 event audit trail • 300 user codes
- Weatherproof, operates from -20 to 151 degrees F (-29 to 66 degrees C)
- Up to 500 scheduled events may be programmed

Mfg #	Description	EZ#
ALDL3500CRL26D	Mort. Classroom LH	072845
ALDL3500CRR26D	Mort. Classroom RH	072846
ALDL3500DBL26D	Mort. deadbolt LH	072847
ALDL3500DBR26D	Mort. deadbolt RH	072848



Trilogy Prox Lock

- 40,000 event audit trail • 2,000 user codes
- Accepts most HID Proximity cards and keyfobs including 26, 33 & 37 bit formats
- Users are individually programmed to use a card only, code only or for the highest security - both card and code
- Weatherproof, operates from -31 to 151 degrees F

Mfg # ALPDL3000 26D EZ # 074032



Accessories

Mfg #	Description	EZ#
ALETPDLS1G26DC50	Exit Trim	082704
ALHID1326	Std. Prox	074039
ALHID1391PK10	Micro Prox	082705
ALHID1346PK10	Prox Keyfob	082706

PK10 = Sold in packs of 10

C50 = For use on CRED5000/Yale 7100



Electric Deadbolts • Parts

PG21

Piercing 95db piezo sounder can be user selected for continuous alarm or 2 min. shutdown with auto reset. Unauthorized use will sound alarm as well as flashing LED. Features include test button, low battery alert, programmable exit/entry delay, inside and outside key control, and two types of tamper proof switches. Requires standard 1 1/8" mortise cylinder for inside key control(not included). Use rim cylinder for outside key control (not included).



Mfg # ALPG21MS (ALUM) EZ # 009762
 Mfg # ALPG21MB (DURO) EZ # 066329

PG30

- Digital codes for Master, Management and Passage (used for Auto-Arming)
- 3 security levels: a) High Security b) Unattended applications c) Flexible control for delivery doors.
- Audible low battery warning
- Logo key is dual function test button.
- 3 Programmable 95db siren styles: sweep,pulsed and steady.



Mfg # ALPG30MS (ALUM) EZ # 062787

Panic Exit Alarms

- U.L. Rated Panic Devices
- Low Battery Alert
- Durable Die Cast Cover
- 9-V Battery
- Selectable 2-min. alarm or constant alarm
- Uses rim cylinders on outside and inside
- Models 250 & 700 provide changeable 2 min. alarm cut off or manual reset
- Model 710 provides changeable 2 min. auto or manual restore

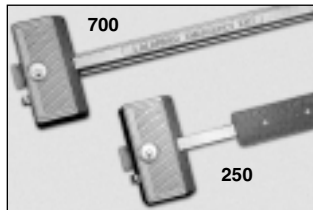

Mfg #	Description	EZ#
AL250 28	Paddle exit alarm	009781
AL700 28	Full bar exit alarm	009789
AL710 28	Auto reset full bar alarm	009790

Model 11A – Paddle Exit Alarm

- Instant automatic exit and alarm in emergency
- 1" non-binding, beveled deadbolt
- Piercing twin horn alarm
- Complies with most standard safety, fire, and building department codes



Mfg # AL11A28 EZ # 009761

Replacement Parts

MFG. #	Description	EZ#
ALBP6	6v battery pack for 11A & PG10	000532
ALAP230MS	Adapter plate retrofits 230 to 250	065037

Model 715 15-Second Delay

- 15-Second delayed egress with instant 95 DB alarm
- Meets NFPA 1012 Life Safety Code
- Input for local 2-wire smoke detector • Monitoring output
- Instant alarmed emergency exit
- 9-volt battery back-up powers siren during power failure



Mfg. # AL715 EZ # 000550

Model 103 & 104RA Electric Deadbolts

Model 103: standard "fail-safe" unit projects the bolt only while power is "on". When the power is off the bolt retracts. Model 104RA (reverse action): "fail-secure" and will project the bolt only when the power is "off". 24 VAC/VDC. When the power is "on" the bolt retracts.



Mfg # AL103 (Fail Safe) EZ# 009758

Mfg # AL104RA (Fail Secure) EZ# 009759

Pilfergard PG10

Twin action alarm sounds when opened by unauthorized personnel. However, the alarm can still be bypassed from inside or outside only by approved key carrying employees. Easy to surface mount, durable and contains two separate types of tamper proof switches. Test button verifies battery (6 volt battery included). Requires standard 1 1/8" mortise cylinder (not included).



Mfg # ALPG10 EZ# 009517

Trilogy Digital Keypad

- 2,000 user codes, master, manager, supervisor and basic
- 100% Fingertip of PC programmable with familiar Trilogy method
- Weatherproof, rugged all-metal 12-button keypad
- 2 High-Current rated 8A relays for entry, alarm zone shunting or lock release by real-time schedule
- 40,000 event audit trail: query by PC or handheld printer or DTM module



Mfg # ALDK3000 26D EZ # 077220

Prox Keypad

Mfg # ALPK3000 26D EZ # 077222



RR-PM1200PAK

- Advanced 1200 lb. electromagnetic lock with infrared remote release
- Complete turnkey system: mag lock, remote control & plug in AC transformer
- Supports up to 100 individual remote controls



Mfg # ALRRPM1200PAK EZ # 075157

5000 Series, 5 Pin Security

- Hardened solid steel body • Maximum security 5 pin cylinder
- Hardened solid steel coverplate • Double steel ball locking
- Easy-to-service rekeyable cylinder

Series 5100

Case: 1 1/2" wide, Shackle diameter: 1/4"

Shackle clear.: 5100 - 1", 5101 - 1 1/2", 5102 - 3"

Mfg#	EZ #
AM5100KA 24685	040041
AM5100KA 33743	040042
AM5100KD	000751
AM5100CC KD	070877
AM5101KA 22753	040043
AM5101KA63755	070888
AM5101KD	000755
AM5102KA 35852	040044
AM5102CCKD	040045



CC - Carded

5200 Series

Case: 1 3/4" wide, Shackle diameter: 5/16"

Shackle clear.: 5200 - 1 1/8", 5201 - 2", 5202 - 3"

Mfg#	EZ #
AM5200KA 22358	040046
AM5200KA 46723	040047
AM5200KA63755	070884
AM5200KD	000766
AM5201KA 34737	040048
AM5201KA63755	070885
AM5201KD	000771
AM5202KA63755	070886
AM5202KA 34753	040049
AM5202KD	000775
AM5200GL	077497



CC - Carded GL - Government padlock (Key retaining locks stamped U.S.)

5260 Series

Case: 2" wide, Shackle diameter: 3/8"

Shackle clear.: 5260 - 1 1/8", 5261 - 2"

Mfg#	EZ #
AM5260KA 63755	040050
AM5260KD	000779
AM5261KA 63742	040055
AM5261KA63755	070887



Series 5570 Brass Body

Case: 2" wide, Shackle diameter: 3/8"

Shackle clear.: 5570 - 1 1/8"

Mfg#	EZ #
AM5570KA 34874	040060
AM5570KD	025902



Weatherbuilt 5500 Series, 5 Pin Security

- Solid one piece brass body • Double steel ball locking
- Maximum security 5 pin cylinder
- Hardened solid steel coverplate

5530 Series

Case: 1 1/2" wide, Shackle diameter: 1/4"

Shackle clear.: 5530 - 1"

Mfg#	EZ #
AM5530KA 34732	040058
AM5530KD	000790



5560 Series Brass Body

Case: 1 3/4" wide, Shackle diameter: 5/16"

Shackle clear.: 5560 - 1 1/8", 5561 - 2", 5562 - 3"

Mfg#	EZ #
AM5560KD	000797
AM5561KD	000800
AM5562KA 35774	040059
AM5562KD	000803



2 3/4" Utility Lock

Mfg# AMC70KA35432 EZ # 069163



Multi Cylinder System

- Accepts Schlage, Assa, Peaks, Primus, Ilco, GMS, Lori and Medeco cylinders
- Only a Phillips screwdriver is needed for cylinder replacement
- Solid extruded brass body • Double Ball Locking
- Chrome plated hardened steel shackle • Padlock less cylinder

Series 3600 Brass Body

Case: 1 3/4" wide, shackle dia: 5/16"

Clear: 1 1/8" (3600) & 3" (3602)

Mfg # AM3600	EZ # 000739
Mfg # AM3602	EZ # 000741



Series 3700 Brass Body

Case: 2" wide, shackle dia: 3/8", clear: 1 1/8"

Mfg # AM3700	EZ # 000742
--------------	-------------



Series 3800 Solid Steel Body

Case: 2 1/4" wide, shackle dia: 7/16"

Clear: 1 1/8" (3800) & 2" (3801)

Mfg # AM3800	EZ # 067419
Mfg # AM3801	EZ # 067420



Cylinder Drivers (required) (6 per pk)

Mfg # AMDRSCH6	Schlage / Assa / GMS	EZ# 000579
Mfg # AMDRLOR6	Lori / LSDA / Ilco	EZ# 000577
Mfg # AMDRMED6	Medeco	EZ # 000578



Keying Kit

Safety Lock-Out Padlocks

- Anodized aluminum body
- Hardened steel shackles and cover plate
- Double ball locking system

Series 1100

Case: 1 1/2" wide, Shackle diameter: 1/4"
Shackle clear.: 1105 - 1", 1106 - 1 1/2", 1107 - 3"



Mfg#	Color	EZ #
AM1105BKD	Blue	040065
AM1105D KA27244	Brown	025921
AM1105CC KD DURO	Brown	028305
AM1105E KD	Green	040064
AM1105G KD	Gold	000660
AM1105K KD	Black	000665
AM1105R KD	Red	000667
AM1106D KA23762	Brown	025922
AM1106R KD	Red	000683
AM1107R KD	Red	038698
AM1107G O BITTED	Gold	074504
AM1107K O BITTED	Black	074505
AM1107N O BITTED	Orange	074506
AM1107R O BITTED	Red	074507
AM1107B O BITTED	Blue	074501
AM1107D O BITTED	Brown	074502
AM1107E O BITTED	Green	074503
AM1107U O BITTED	Purple	074498



AM1105



AM1205



AM1305

Series 1200

Case: 1 3/4" wide, Shackle diameter: 5/16" & clear.: 1 1/8"

AM1205D KA43753	Brown	025927
AM1205D KD	Brown	000691
AM1205R KD	Red	000698
AM1205B KD	Blue	000688

Series 1300

Case: 2" wide, Shackle diameter: 3/8" & clear.: 1 1/8"

AM1305D KA53762	Brown	025930
-----------------	-------	--------

7200 Series, Tubular

- Hardened solid steel body • Hardened solid steel coverplate
- 7-pin tubular cylinder • Double steel ball locking
- Case: 1 3/4" wide, Shackle diameter: 5/16"
- Shackle Clearance: 7200 - 1 1/8", 7202-3"

Mfg#	EZ #
AM7200KD	000824
AM7200KA 15057	040070
AM7202KD	040071
AM7202KA 15057	070891



Series 30

Aluminum padlock, 1 1/2" x 3/4" body, 3/4" shackle

Mfg # AM30KA3	EZ # 069455
Mfg # AM30KD	EZ # 069454



Series 7300, Tubular

Case: 2 1/4" wide, Shackle diameter: 7/16"
Shackle Clear: 7300 - 1 1/8", 7301 - 2"

Mfg#	EZ #
AM7300KA 00222	040072
AM7300KA 22200	073797
AM7300KD	000836
AM7301KA00222	074036



3500 Series - Solid One-Piece Extruded Brass Body

- Accepts Best, Arrow, Everest, Falcon, KSP and Peaks cylinders
- Case: 1 3/4", Shackle diameter: 5/16"
- Shackle clear.: 3560 - 1 1/8", 3561 - 2", 3562 - 3"

Mfg#	EZ #	
AM3560	000733	<i>sold less I/C core</i>
AM3561	000734	
AM3562	000735	



AM3560

Replacement Parts Kit

For servicing American rekeyable pin tumbler locks

Mfg # AMSK8 EZ # 000639



Bottom Pins

Mfg. #	EZ #
AM3682010 #1	000601
AM3682020 #2	060388
AM3682030 #3	060387
AM3682090 #4	000604
AM3682050 #5	000605
AM3682060 #6	000606
AM3682070 #7	000607
AM3682080 #8	060389

Master Wafers

Mfg. #	EZ #
AM3681050 #2	000610
AM3681010 #3	000611
AM3681020 #4	000612
AM3681030 #5	000613
AM3681040 #6	000614
AM3681070 #7	061689

Professional Specialty 2000 Series

Solid one piece body reinforced with nine hardened 1/4" steel pins (3 1/16" dia. x 1 9/16" thick). High security 6-pin tumbler design with mushroom pins makes it virtually impossible to pick.

Mfg#	EZ #
<i>Die Cast Steel</i>	
AM2000KA 84001	040068
AM2000KD	000717
<i>Solid Steel</i>	
AM2010KA 84632	073963



High Security Round Body

- Drill proof swivel plate • Pull proof cylinder

Mfg#	EZ #
AM2500KA00061D	077941
AM2500KD	077701





700 Series

Mfg#	EZ #
<i>Case: 2 1/2", Shackle dia: 7/16", clear. 1 1/16"</i>	
AM700KA 22732	040061
AM700KA 35257	040062
AM700KA 63755	070889
AM700KD	000816
AM700CC KD	070879



701 Series

Mfg#	EZ #
<i>Case: 2 1/2", Shackle dia: 7/16", clear. 2"</i>	
AM701KA 22238	040063
AM701KA 63755	070890
AM701KD	000822
AM701CC KD	070878

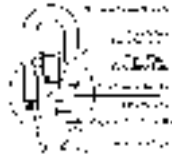

5300 Series / 748 Series

- Solid steel body • Double steel ball locking
- Protective shroud prevents shackle cutting
- Rekeyable & interchangeable cylinders

Mfg#	EZ #
<i>Case: 1 3/4", Shackle dia: 5/16", clear. 1 1/8"</i>	
AM5300KA 66272	000783
AM5300KA27244	028821
AM5300KD	000784
AM5300CC KD	050412
<i>Case: 2", Shackle dia.: 3/8", clear. 1 1/8"</i>	
AM5360KA26868	028820
AM5360CCKD	040057
<i>Case 2 1/2", Shackle dia. 7/16", clear 1"</i>	
AM748KD	000842



American Defender Pepper Spray

Mfg. #	Desc.	EZ#
AMAD100CC	1/2 oz. leather case	070494
AMAD101CC	1/2 oz. plastic case	070495
AMAD102CC	2 1/2 oz. canister	070496



Misc.

Mfg#	Description	EZ #
AMBKB	Blade Tumbler key blank	000559
AMPTKB1	5 Pin Tumbler key blank	000634
AMPTKB2	6 Pin Tumbler key blank	000635
AMPT748	Model 748 key blank	000637
AMLPKB-4	B30 key blank	040075
AM4746010	Security Nut	069958
AM4761010	Security Screw	069959
AM1582290	2" shackle for 1205	035104
AM1582960	2" shackle for 700	068287

Resettable Combination Locks

Mfg # AMRS20TCC EZ # 065668
Body width: 3/4", Shackle Length 7/8"



Mfg # AMRS441CC EZ # 065669
Body width: 1 1/2", Shackle Length 1 1/4"

Discus Padlock

Mfg # AMD100C EZ # 065670
2 3/4" wide, 3/8" shackle, 4 pin, stainless steel



Solid Steel Hasps

Outdoor or automotive, 8 1/2" x 4 1/2"

Mfg # AM800 EZ # 072118



Straight bar, 7 1/4" x 1 5/8"

Mfg # AM825 EZ # 066230

Mfg # AM825CC EZ # 070880



90° angle bar, 4 1/4" x 1 5/8"

Mfg # AM850 EZ # 025918

Mfg # AM850CC EZ # 070883



Centered hole - boxed

5" x 2", 6 carriage bolts

Mfg # AM535 EZ # 000785



Heavy Wrought Steel Multi-Purpose Flex-O-Hasp

Single hinge 6 1/4" x 1 3/4"

Mfg # AM875 EZ # 025919

Mfg # AM875CC EZ # 070881



Double hinge 7 3/4" x 1 3/4"

Mfg # AM885 EZ # 025920

Mfg # AM885CC EZ # 070882



Locking Bolt Hasps

Heavy-duty, high security. 3/4" solid hardened steel throw is fully adjustable from 3/4" to 2 3/8". All components are chrome plated.

Mfg # AM895 EZ # 000848



Replacement Cylinders

For 700, 1000 & 5000 series padlocks with protective cover plates

Mfg # AMPTC12KA22327 EZ # 000627

Mfg # AMPTC12KD EZ # 000630



For 7000 series tubular padlocks.

Mfg # AMHTC2KA 39289 EZ# 040040



For American Blade Tumbler Padlocks (uncoded)

Mfg # AMBTC1U EZ # 000561

For American Model 2000

Mfg # AMPT2001KA 81784 EZ# 040069



For 700, 1000 & 5000 Series (Master Lock 1K keyway)

Mfg # AMPTM1 EZ# 038803

For tubular inner cylinder locks

Mfg # AM8300KA 15129 EZ# 040073

Mfg # AM8300KD EZ# 040074





Tambour Depository Safes

Depository Safe

- B-Series safe with a body constructed of solid steel plate • Front loading access • Interchangeable doors
- Full chrome plated bolt mechanism automatically extends 1" dia. bolts into body when door is closed
- Powder Coating • Adjustable shelves • Spring loaded relocker device
- UL listed Group II combination lock, and/or UL listed single or double nose lock

Mfg. #	Inside	Outside	capacity	wt	EZ #
EGMS1K	7.5" x 5.5" x 10.5"	7.75" x 6" x 12"	433 cu in	12	076739
EGMS1C	7.5" x 5.5" x 10.5"	7.75" x 6" x 12"	433 cu in	12	076740
EGMS2K	7.5" x 5.5" x 10.5"	7.75" x 6" x 12"	433 cu in	12	075455
EGF2015C	13" x 14.75" x 12"	20" x 15" x 15"	2301 cu in	104	075456
EGF2015C-LOC	13" x 14.75" x 12"	20" x 15" x 15"	2301 cu in	104	075446
EGF2015K	13" x 14.75" x 12"	20" x 15" x 15"	2301 cu in	104	075447
EGF2015K-LOC	13" x 14.75" x 12"	20" x 15" x 15"	2301 cu in	104	075480
EGF2415C	17" x 14.75" x 12"	24" x 15" x 15"	3009 cu in	146	075457
EGF2415K	17" x 14.75" x 12"	24" x 15" x 15"	3009 cu in	146	075458
EGF2424C	17" x 23.75" x 17"	24" x 24" x 20"	6864 cu in	199	075459
EGF2424K	17" x 23.75" x 17"	24" x 24" x 20"	6864 cu in	199	075460
EGF2820C (inner comp)	7" x 19.75" x 14"	28" x 20" x 20"	1936 cu in	236	075461
	19" x 19.75" x 16"		3792 cu in		
EGF2820K (inner comp)	7" x 19.75" x 14"	28" x 20" x 20"	1936 cu in	236	075451
	19" x 19.75" x 16"		3792 cu in		
EGF2824C (inner comp)	7" x 23.75" x 14"	28" x 24" x 20"	2328 cu in	213	075452
	19" x 23.75" x 16"		4560 cu in		
EGF2824K	19" x 23.75" x 16"	28" x 24" x 20"	6888 cu in	213	075453
EGF3020DDCC (top)	10" x 19.75" x 16"	30" x 20" x 20"	3160 cu in	236	075454
	(btm) 12" x 19.75" x 16"		3792 cu in		
EGF3020DDKC (top)	10" x 19.75" x 16"	30" x 20" x 20"	3160 cu in	236	075445
	(btm) 12" x 19.75" x 16"		3792 cu in		



F2015-LOC

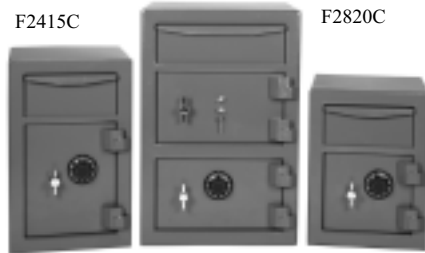

F2415C

F2820C

F2015C



MS1K

MS1C

Wall Safes

- Size: 17" x 11.75" x 4" ext. / 14" x 9" x 3.75" int.
- Weight: 10 lbs. • Anti-pry steel door hinge • Double thick 1/8" steel door
- Made to mount between 16" on-center studs or joists

Mfg # EG4WS EZ # 078014



Tambour Depository Safe

- Front loading rotary drum hopper • Spring loaded relocker device
- B-Series safe with a body constructed of solid steel plate • Powder Coating
- Front loading access • Interchangeable doors • Adjustable shelves
- Auto lock feature - full chrome plated bolt mechanism automatically extends the 1" diameter bolts into the body when door is closed
- UL listed Group II combination lock and/or UL listed single or double nose lock

Mfg. #	Inside	Outside	capacity	wt	EZ #
EGTB2415C	17" x 14.75" x 12"	24" x 15" x 15"	3009 cu in	161	075448
EGTB2820C	(inner) 7" x 19.75" x 14"	28" x 20" x 20"	1936 cu in	251	075449
	19" x 19.75" x 16"		3792 cu in		
EGTB4020C	(inner) 7" x 19.75" x 14"	40" x 20" x 20"	1936 cu in	291	075450
	31" x 19.75" x 16"		7584 cu in		



TB2820



TB4020



When drawer is opened, a cylindrical rotary hopper rotates 90° upward, exposing a spacious drum opening for bank bags, cash and documents. When drawer is closed, a hopper rotates downward 90° to drop the deposit into the receiving compartment. At no point during the cycle is there any opportunity to insert tools to fish out the contents.



Euro Vault

- Composite door & body, one-hour fire protection
- U.L. Group II lock with satin dial, dial ring & handle
- High security construction, using max density aggregate compound with steel matrix
- 50 mm barrier walls and door slab
- Chrome-plated 30 mm bolts in 3-way mechanism

Mfg. #	Inside	Outside	capacity	wt	EZ #
EGEFP1713	17" x 13" x 13"	21" x 17" x 19.5"	1.6 cu ft	380	076381
EGEFP1717	17" x 17" x 17"	21" x 21" x 23.5"	2.8 cu ft	510	075435
EGEFP2417	24" x 17" x 17"	28" x 21" x 23.5"	4.2 cu ft	625	075436
EGEFP3417	34" x 17" x 17"	38" x 21" x 23.5"	5.6 cu ft	810	075437
EGEFP4517	45" x 17" x 17"	49" x 21" x 23.5"	7.5 cu ft	1084	076625

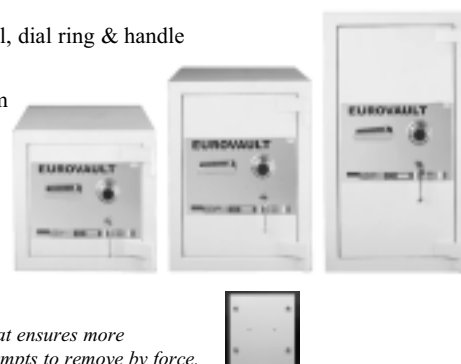

Each Euro Vault EFP comes with the revolutionary Anti-Theft Platform, an exclusive innovation that ensures more accurate and secure installation. A four-point anchoring system and pry-resistant design deters attempts to remove by force.

Utility Chest

- B-Series safe with a body constructed of solid steel plate
- Interchangeable doors
- Auto lock feature - full chrome plated bolt mechanism automatically extends the 1" diameter bolts to the body when door is closed
- Powder Coating
- Adjustable shelves
- Spring loaded relocker device
- UL listed Group II combination lock and/or UL listed single or double nose lock

Mfg. #	Inside	Outside	capacity	wt	EZ #
EGUC1616C	15.75" x 15.75" x 12"	16" x 16" x 16"	2,976 cu in	96	075444
EGUC1818C	17.75" x 17.75" x 14"	18" x 18" x 18"	4,410 cu in	114	075440
EGUC2024C	19.75" x 23.75" x 16"	20" x 24" x 20"	7,505 cu in	199	075442
EGUC2618C	25.75" x 17.75" x 14"	26" x 18" x 18"	6,399 cu in	169	075441
EGUC2624C	25.75" x 23.75" x 16"	26" x 24" x 20"	9,785 cu in	232	075443
EGUC3024C	29.75" x 23.75" x 16"	30" x 24" x 20"	11,305 cu in	256	075439



Cash Boxes

Mfg. #	Dimensions	Color	Tray	Sect	wt	EZ #
EG67 0	2.5" x 5.5" x 3.5"	Maroon	n/a	n/a	.6	082020
EG67 1	2.75" x 6.5" x 4.5"	Green	0	3	1	082021
EG67 2	2.75" x 7.75" x 6"	Red	1	5	1.5	082022
EG67 3	3" x 9" x 7.25"	White	1	5	2.5	082023
EG67 4	3.25" x 11.5" x 8.25"	Blue	1	5	3.6	082024
EG67 5	3.5" x 16.25" x 11"	Beige	1	8	7	082025



Toy Safe

- Mini safe with combo for kids.
- Size: 6.75" x 4.25" x 3.25"
- Weight: 2 lbs.
- Capacity: 80 cubic inches

Mfg # EGTOYSAFE
EZ # 075438



LD Series Foundation Safes

Thick steel doors lift out completely to allow full access to the safe contents. Body constructed of continuously welded steel. UL Group II combination lock mounted on the door. Passive relocking device which will "freeze" locking mechanism in engaged position if forced entry is attempted. A super-heavy dust lid/floor cover is included.

Mfg. #	Inside	Outside	capacity	wt	EZ #
EGLD10	8.75" x 8.75 x 6"	9.5" x 9.5" x 10"	473 cu in	48	083614
EGLD16	8.75" x 8.75" x 12"	9.5" x 9.5" x 16"	946 cu in	51	075646
EGLD19	8.75" x 8.75" x 15"	9.5" x 9.5" x 19"	1183 cu in	57	075647



UL Class 350 1 Hour Patriot Safes

- Withstand fires up to 1700° F for 1 hour
- Made in the U.S.A.
- Independent spring-loaded relocker

Mfg. #	Inside	Outside	capacity	wt	EZ #
EGPV1512	15" x 12" x 11.5"	21" x 17" x 17.5"	1.2 cu feet	150	082017
EGPV1713	17" x 13.5" x 15"	23" x 18.5" x 21"	2 cu feet	205	082018
EGPV2015	20" x 15" x 15"	26" x 20" x 21"	2.6 cu feet	250	082019





Q Series Heavy Duty Lever Locksets

- Meets ANSI Grade 1 - high frequency usage.
- UL listed for "A" label or lesser doors
- Extra heavy duty independent springs to prevent lever sag.
- Thru bolting to prevent chassis rotation.
- Non-handed
- Backset - 2 3/4"
- Door thickness: 1 3/4" to 2"
- Made in USA



Formerly "H" Series

Mfg #	Lever	Fin	Function	EZ #
AWQ01SR26D	Sierra	26D	Passage	071391
AWQ02SR26D	Sierra	26D	Privacy	071392
AWQ11SR26D LC	Sierra	26D	Entry	071076
AWQ12SR26D LC	Sierra	26D	Storeroom	064230

LC - Less Cylinder

M Series Sierra Leversets

- Meets ANSI 156.2 series 4000 Grade 2 requirement
- UL listed for "A" label or lesser doors
- Medium duty lock built on heavy duty chassis
- Thru bolted within 161 prep for retrofit and secure installation
- Non handed lever supported with coil springs enabling them to rotate in either direction
- Backset - 2 3/4"
- Door thickness: 1 3/8" to 1 3/4"
- Made in USA



Sierra

Mfg #	Fin	Function	EZ #
AWM01SR10	10	Passage	070895
AWM01SR10B 2/34	10B	Passage	066174
AWM01SR26D 2 3/4	26D	Passage	029325
AWM01SR3 2 3/4	3	Passage	029326
AWM02SR10 2 3/4	10	Privacy	070901
AWM02SR10B 2 3/4	10B	Privacy	066183
AWM02SR26D 2 3/4	26D	Privacy	029327
AWM02SR3 2 3/4	3	Privacy	029328
AWM11SR10	10	Entrance	068288
AWM11SR10B 2 3/4	10B	Entrance	070906
AWM11SR26D	26D	Entrance	028933
AWM11SR IC 26D 2 3/4	26D	Entrance	028918
AWM11SR26D CS	26D	Entrance	068289
AWM11SR3	3	Entrance	028931
AWM12SR10 2 3/4	10	Storeroom	070900
AWM12SR10B 2 3/4	10B	Storeroom	070907
AWM12SR26D 2 3/4	26D	Storeroom	028935
AWM12SR3 2 3/4	3	Storeroom	028934
AWM33SR3	3	Asylum	072268
AWM33SR10B	10B	Asylum	072269
AWM33SR26D	26D	Asylum	026062

CS = Schlage C Kwy. IC = Accepts Interchangeable Core

Latches

Mfg.	Fin.	BS	Faceplate	EZ #
<i>Spring Latch For M Series Knobs</i>				
AW101 3	3	2 3/8"	Flat 1" wide	001672
AW101 26D	26D	2 3/8"	Flat 1" wide	001671
AW104 26D	26D	2 3/4"	Flat 1 1/8" wide	001673
<i>Dead Latch For M Series Knobs</i>				
AW111 10B	10B	2 3/8"	Flat 1" wide	062066
AW111 3	3	2 3/8"	Flat 1" wide	001678
AW111 26D	26D	2 3/8"	Flat 1" wide	001677
AW114 3	3	2 3/4"	Flat 1 1/8" wide	001681
AW114 10B	10B	2 3/4"	Flat 1 1/8" wide	062067
AW114 26D	26D	2 3/4"	Flat 1 1/8" wide	001680
<i>Dead Latch For SR & BRR Levers (U.L. Listed)</i>				
AW281 26D	26D	2 3/8"	Flat 1" wide	001719
AW284 26D	26D	2 3/4"	Beveled 1 1/8" wide	001721

Drive-In For M Series Knobs

Mfg # AW116 Dia: 1" BS: 2 3/4" EZ # 062069



M Series Cylindrical Locks

- Meets ANSI 156.2 series 4000 Grade 2 requirement
- UL listed for “A” label or lesser doors, non UL for other applications
- Standard duty for light commercial
- Quiet, smooth, dependable operation
- Steel, brass and alloy construction
- Backset - 2 3/4” standard, unless 2 3/8” specified
- Door thickness: 1 3/8” to 1 3/4” • Made in USA



Mfg#	Knob	Fin.	Backset	KWY	EZ #
Passage Sets					
AWM01BD26D	Ball	26D	2 3/4”	N/A	040091
AWM01BD5A 2 3/8	Ball	5A	2 3/8”	N/A	062833
Privacy Sets					
AWM02BD26D 2 3/4	Ball	26D	2 3/4”	N/A	026085
Entrance Locksets – With T Strike					
AWM11BD3KA4 2 3/8	Ball	3	2 3/8”	Arrow	026072
AWM11BD US3 KA4 2 3/8CS	Ball	3	2 3/8”	Schlage C	061557
AWM11BD5A KA4 2 3/4	Ball	5A	2 3/4”	Arrow	026075
AWM11BD10	Ball	10	2 3/4”	Arrow	062051
AWM11BD10B KA4 2 3/4CS	Ball	10B	2 3/4”	Schlage C	061555
AWM11BD10B KA4 2 3/4	Ball	10B	2 3/4”	Arrow	026077
AWM11BD26D KA4 2 3/4CS	Ball	26D	2 3/4”	Schlage C	061556
AWM11BD26D KA4 2 3/4	Ball	26D	2 3/4”	Arrow	026076
AWM11TA3KA4 2 3/8	Tudor	3	2 3/8”	Arrow	026039
AWM11TA5A KA4 2 3/8	Tudor	5A	2 3/8”	Arrow	026043
AWM11TA26D KA4 2 3/8	Tudor	26D	2 3/8”	Arrow	026044
Storeroom Locksets					
AWM12BD3KA4 2 3/8	Ball	3	2 3/8”	Arrow	026074
AWM12BD26D KA4 2 3/4	Ball	26D	2 3/4”	Arrow	026079
AWM12BD3	Ball	3	2 3/4”	Arrow	062053
AWM12BD5A 2 3/8	Ball	5A	2 3/8”	Arrow	070916
AWM12BD10B KA4 2 3/4CS	Ball	10B	2 3/4”	Schlage C	061559
AWM12BD10B KA4 2 3/4	Ball	10B	2 3/4”	Arrow	040088
AWM12BD10 2 3/4	Ball	10	2 3/4”	Arrow	070905
AWM12BD26D KA4 2 3/4CS	Ball	26D	2 3/4”	Schlage C	061560
AWM12TA3KA4 2 3/8	Tudor	3	2 3/8”	Arrow	026046
AWM12TA26DKA4	Tudor	26D	2 3/4”	Arrow	040089
Classroom Locksets					
AWM17BD26D 2 3/4CS	Ball	26D	2 3/4”	Schlage C	062829
Asylum Locksets					
AWM33BD3	Ball	3	2 3/4”	Arrow	072266
AWM33BD26D	Ball	26D	2 3/4”	Arrow	072267

CS = SC1 Keyway

BALL BD KNOB
Knob: 2 1/8” dia.
Projection: 2 11/16” on
1 3/4” door



TUDOR TA KNOB
Knob: 2 1/8” dia.
Projection: 2 1/8” on
1 3/4” door



M Series Locksets - I/C 2 3/4” Backset

Mfg #	Design	Fin	Function	EZ #
AWM11TAIC26D	Tudor	26D	Entrance	026052
AWM12TAIC26D	Tudor	26D	Storeroom	040090

Note: I/C core not included

Tudor Knob
I/C 2 3/4 B.S.





E Tubular Deadlocks

Mfg #	Fin.	BS	EZ #
AWE61 3 141	3	2 3/8"	031251
AWE61 5A KA4 141	5A	2 3/8"	063507
AWE61 10B KA4 141	10B	2 3/8"	062046
AWE61 10 395 144CS KA4 10	10	2 3/4"	077047
AWE61 10KA4 141	10	2 3/8"	062047
AWE61 26D KA4 141	26D	2 3/8"	065565
AWE62 3KA4 141	3	2 3/8"	065568
AWE62 3CS KA4 141	3	2 3/8"	061562
AWE62 5A KA4 141	5A	2 3/8"	065567
AWE62 5A CS KA4 141	5A	2 3/8"	061554
AWE62 26DKA4 141	26D	2 3/8"	040092

CS = SC1 Keyway



E61 Single Cylinder



E62 Double Cylinder

Doors: 1 3/8" to 1 3/4" thick. **Bolt:** 1" throw with hardened solid steel pin.
Strike: S92 Standard: 2 3/4" x 1 1/8". **Cylinder:** 5 pin solid brass.
Keying: KA4 standard – Arrow Keyway.

D Series Tubular Deadlocks - I/C Less Core

Mfg #	Fin.	BS	EZ#
<i>Single Cylinder</i>			
AWD61IC26D 144	26D	2 3/4"	026105
<i>Double Cylinder</i>			
AWD62IC26D 144	26D	2 3/4"	060524



130 Series Exit Alarm

- Non-ferrous alloy cover and base 8 3/8" x 2" x 2 5/8"
- 9 volt battery powered
- Low battery alert
- Non-handed
- 15 second delay
- Magnet activated
- Red LED indicator flashes and can only be turned off by inside key

Mfg #	Fin.	EZ#
AW130AL	Aluminum	013359
AW130BRZ	Bronze	071077

1 1/8" Mortise Cylinder NOT Included



1250 Series Rim Exit Device

- Certified to conform to the standards of ANSI/BHMA A156.3 Type 1 Grade 1
- **FS1250:** Labeled for 3 hour or lesser fire doors. • F rail - for doors up to 36"
- U.L. and C.U.L listed for panic, standard. • Made in the USA

Mfg # AWFS1250 AL EZ # 075515 Mfg # AWS1250AL36 EZ # 072988



Deadbolt Bolts

Mfg#	Fin.	BS	Faceplate	EZ #
AW141 3	3	2 3/8"	1 x 2 1/4"	001694
AW141 26D	26D	2 3/8"	1 x 2 1/4"	001693
AW144 3	3	2 3/4"	1 1/8" x 2 1/4"	001696
AW144 26D	26D	2 3/4"	1 1/8" x 2 1/4"	001695
AW145 26D	26D	2 3/8"	RFL	001697
AW146 26D	26D	2 3/4"	RFL	001699

RFL = Drive In

Tailpieces

Mfg#	Description	EZ #
AW92C44 1 7/8	1 7/8" Std - Single Cyl	001640

IC Core

C7S - 7 pin core, uncombined

Mfg # AWC7S DB US4 EZ # 077248

Mfg # AWC7S DB US26D EZ # 077249



Original Key Blanks

Mfg # AWK5A 5 Pin Brass EZ # 026137

Mfg # AWK6A 6 Pin Nickel Silver EZ # 040095



IGNITION LOCKS

Mfg # ASC42 110 *EZ # 067251*
10-cut small ears chrome, random cuts

Mfg # ASC42 111 *EZ # 061384*
Fits 1986-92 (#1 depth) Aerostar 10-cut

Mfg # ASC42 112 *EZ # 061380*
Fits 1986-92 (#2 depth) Aerostar 10-cut

Mfg # ASC42 113 *EZ # 061381*
Fits 1986-92 (#3 depth) Aerostar 10-cut

Mfg # ASC42 114 *EZ # 061382*
Fits 1986-92 (#4 depth) Aerostar 10-cut

Mfg # ASC42 115 *EZ # 061383*
Fits 1986-92 (#5 depth) Aerostar 10-cut

Mfg # ASC42 117 *EZ # 066130*
10-cut small ears chrome uncoded

Mfg # ASC42 120 *EZ # 067252*
10-cut small ears black, random cuts

Mfg # ASC42 121 *EZ # 028460*
Fits 1984 1/2-91 Thunderbird & Cougar, 1986-91 Aerostar, 1985-89 Lincoln Mark VII, Town Car, 1986-87 Lincoln Continental & 1988-90 Escort, Topaz & Tempo - H54 kwy black only with a number 1 cut in the 5th position from the bow

Mfg # ASC42 122 *EZ # 028459*
Same as ASC42 121 except with a # 2 cut

Mfg # ASC42 123 *EZ # 051165*
Same as ASC42 121 except with a # 3 cut

Mfg # ASC42 124 *EZ # 028457*
Same as ASC42 121 except with a # 4 cut

Mfg # ASC42 125 *EZ # 028456*
Same as ASC42 121 except with a # 5 cut

Mfg # ASC42 127 *EZ # 066131*
10-cut small ears black uncoded

Mfg # ASC42 131 *EZ # 028455*
Fits 1986-89 Taurus & Sable & 1988-89 Lincoln Continental w/ a #1 cut in the 5th position from the bow or the 6th position from the tip of the original key - H55 kwy.

Mfg # ASC42 132 *EZ # 028454*
Same as ASC42 131 except with a # 2 cut.

Mfg # ASC42 133 *EZ # 028453*
Same as ASC42 131 except with a # 3 cut.

Mfg # ASC42 134 *EZ # 028452*
Same as ASC42 131 except with a # 4 cut.

Mfg # ASC42 135 *EZ # 028451*
Same as ASC42 131 except with a # 5 cut.

Mfg # ASC42 137 *EZ # 066126*
10-cut dome uncoded

Mfg # ASC42 140 *EZ # 066382*
10-cut big ears black, random cuts

Mfg # ASC42 141 *EZ # 043929*
Fits 1990-95 Taurus with a number 1 cut.

Mfg # ASC42 142 *EZ # 043930*
Fits 1990-95 Taurus with a number 2 cut.



C-42-121



C-42-131



C-42-141

IGNITION LOCKS (cont'd)

Mfg # ASC42 143 *EZ # 043931*
Fits 1990-95 Taurus with number 3 cut

Mfg # ASC42 144 *EZ # 043932*
Fits 1990-95 Taurus with number 4 cut

Mfg # ASC42 145 *EZ # 043933*
Fits 1990-95 Taurus with number 5 cut

Mfg # ASC42 147 *EZ # 066132*
10-cut big ears black uncoded

Mfg # ASC42 150 *EZ # 067254*
10-cut big ears chrome, random cuts

Mfg # ASC42 151 *EZ # 050043*
Fits 1990-95 Lincoln with number 1 cut

Mfg # ASC42 152 *EZ # 043934*
Fits 1990-95 Lincoln with number 2 cut

Mfg # ASC42 153 *EZ # 043935*
Fits 1990-95 Lincoln with number 3 cut

Mfg # ASC42 154 *EZ # 043936*
Fits 1990-95 Lincoln with number 4 cut

Mfg # ASC42 155 *EZ # 043937*
Fits 1990-95 Lincoln with number 5 cut

Mfg # ASC42 157 *EZ # 066128*
10-cut big ears chrome uncoded

Mfg # ASC42 160 *EZ # 067255*
Fits 1995-up Ford Contour.

Mfg # ASC42 161 *EZ # 061375*
Fits 1995-up Contour/Myst. with number 1 cut

Mfg # ASC42 162 *EZ # 061376*
Fits 1995-up Contour/Myst. with number 2 cut

Mfg # ASC42 163 *EZ # 061377*
Fits 1995-up Contour/Myst. with number 3 cut

Mfg # ASC42 164 *EZ # 061378*
Fits 1995-up Contour/Myst. with number 4 cut

Mfg # ASC42 165 *EZ # 061379*
Fits 1995-up Contour/Myst. with number 5 cut

Mfg # ASC42 167 *EZ # 066134*
Ford Contour uncoded

Mfg # ASC42 181 *EZ # 067256*
8-cut coded Taurus

Mfg # ASC42 182 *EZ # 067257*
8-cut uncoded Taurus

Mfg # ASC42 184 *EZ # 067258*
8-cut HUF type, random cuts

Mfg # ASC42 185 *EZ # 067259*
8-cut HUF type uncoded

Mfg # ASC42 188 *EZ # 077898*
2000 -up Ford Focus, LSP

Mfg # ASC42 193 *EZ # 066133*
Fits 1991-96 Escort uncoded man. trans.

Mfg # ASC42 194 *EZ # 066135*
Fits 1991-96 Escort uncoded auto. trans.



C-42-151



Foreign Automotive Locks: Acura - Nissan/Datsun

IGNITION LOCKS (cont'd)

Mfg # ASC42 406 EZ # 067260
Fits 76 - up 5 pin

Mfg # ASC42 407 EZ # 067261
Fits 76 - UP 5 pin ign with pigtail

IGNITION SERVICE PACKAGE

Mfg # ASA42 111 EZ # 066129
Ford 10 cut side bar ignition kit

DOOR LOCKS

Mfg # ASD20 109 Ford Probe EZ # 043956

Mfg # ASD42 211 EZ # 001201
RH DR Svc. Pkg. Taurus/Sable

Mfg # ASD42 212 EZ # 001202
LH DR Svc. Pkg. Taurus/Sable

Mfg # ASD42 221 EZ # 001206
Fits 1984 1/2-88 Thunderbird & Cougar, 1986-91 Aerostar, 88-90 Escort and 90-91 LTD Crown Victoria & Mercury Marquis – uncoded service package only – contains an uncoded plug, lock case, dust cover & shutter assembly and face cap

Mfg # ASD42 222 EZ # 001207
The same as ASD42 221 except black

Mfg # ASD42 231 EZ # 067274
Service package, chrome



D-42-221



D-42-222

DOOR KITS

Mfg # ASA42 113 Ford Focus 2000 EZ # 074823

TUMBLERS/SPRINGS

Mfg # ASP42 190 10 cut tumbler spring EZ # 073799

Mfg # ASP42 191 10 cut tumbler #1 EZ # 070792

Mfg # ASP42 192 10 cut tumbler #2 EZ # 070793

Mfg # ASP42 193 10 cut tumbler #3 EZ # 070794

Mfg # ASP42 194 10 cut tumbler #4 EZ # 070795

Mfg # ASP42 195 10 cut tumbler #5 EZ # 072489

DOOR PLUGS - UNCODED

Mfg # ASD42 208 EZ # 051178
Fits 1991-94 Explorer (lock service package).

Mfg # ASD42 291 EZ # 001209
Fits 1991-93 Escort.

DOOR & TRUNK LOCK PARTS

Mfg # ASP42 231 EZ # 001299
Shutter assembly

Mfg # ASP42 232 EZ # 001300
Same as ASP42 231 except black

Mfg # ASP42 301 EZ # 001301
Plastic pawl for most Taurus, Sable, Tempo, Topaz, Thunderbird & Cougar models and 88-89 Lincoln Continental – right side only

Mfg # ASP42 302 EZ # 001302
Same as ASP42 301 except left side only

Mfg # ASP42 303 EZ # 001303
Plastic pawl for most models of Aerostar & Escort, 85-89 Lincoln Town Car, 85-87 Lincoln Cont'l. & some locks with lighted keyhole



P-42-231



P-42-302

FACE CAPS 10 PER PACK

Mfg # ASP20 209 EZ # 001246
Ford Probe face cap

Mfg # ASP40 201 EZ # 051190
Ford Aspire face cap

Mfg # ASP42 201 EZ # 001286
Round chrome style

Mfg # ASP42 202 EZ # 001287
Round black style

5 PER PACK

Mfg # ASP42 211 EZ # 001291
Fits 1986-90 Taurus, Sable, 1988-90 Tempo & Topaz without a lighted keyhole – right side

Mfg # ASP42 212 EZ # 001292
Same as ASP42 211 except left side

Mfg # ASP42 268 EZ # 067308
Ford Windstar 1996-98 black cap RH

Mfg # ASP42 269 EZ # 067309
Ford Windstar 1996-98 black cap LH



P-42-201



P-42-211

ACURA

IGNITION LOCKS - CODED

Mfg # ASC19 108 EZ # 001131
Fits Integra 1986-89 – X128 kwy

Mfg # ASC19 109 EZ # 001132
Fits Legend 1986-90 – X128 kwy



C-19-108

AUDI

IGNITION LOCKS - CODED

Mfg # ASC31 104 EZ # 001166
Fits 1978-79, 1980-84 4000 series, and 1978-83 5000 series cars – X9/X88 kwy



C-31-104

CHEVROLET (JAPAN / USA)

IGNITION LOCKS - CODED

Mfg # ASC30 107 EZ # 001151
Fits Nova 1984-87 models, except with cylinder retaining pin at the rear of the cylinder assembly – X137 kwy

FACE CAPS - 10 PER PACK

Mfg # ASP30 202 EZ # 001263
Fits door locks 1981-up



C-30-107

DATSUN / NISSAN

IGNITION LOCKS - CODED

Mfg # ASC16 106 EZ # 001117
Fits 210, 310 1979-82, 510, 810 1978-81 and 200SX, 280Z, 280ZX 1977-83 – X6 kwy

Mfg # ASC16 107 EZ # 001118
Same as ASC16 106 – X7 kwy

DATSUN / NISSAN

IGNITION LOCKS - CODED (cont'd)

Mfg # ASC16 110 EZ # 001119

Fits B210, F10, 610, 710, 240Z, 260Z
1970-73; 1200, B110 1980-82 - X7 kwy

Mfg # ASC16 126 EZ # 029634

Fits 240SX 1989-91, Pathfinder, Pick-ups 1987-91 and Pulsar 1990-91

Mfg # ASC16 127 EZ # 001125

Fits 200SX 1987-88, 300ZX 1990-91, Maxima, Sentra 1987-91, Pulsar 1987-89, Stanza 1987-90 and Van 1986-89 - X123

Mfg # ASC16 129 EZ # 001127

Fits 1991 Sentra.



C-16-127

DOOR LOCKS - CODED

Mfg # ASD16 106 EZ # 001170

Fits most 1982-up models - X123 kwy.

Mfg # ASDP16 106 EZ # 050055

Pair of ASD16 106.

Mfg # ASD16 206 EZ # 043948

Datsun door lock service pkg. - X123 kwy.



D-16-106

DOOR/TRUNK PLUGS - UNCODED

Mfg # ASB16 305 EZ # 001097

Used with ASD16 106 and many door handles on 1982-up models - X123 kwy.



B-16-305

TRUNK LOCKS - CODED

Mfg # ASB16 103 EZ # 043854

Fits Nissan Maximum 89 - 92.

Mfg # ASB16 105 EZ # 001092

Fits most 1982-up sedans - X123 kwy.

Mfg # ASB16 108 EZ # 029324

Fits 240SX 1989-91 and Sentra Sedan, Stanza (except wagon) 1987-90.

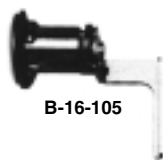

B-16-105

Mfg # ASB16 117 EZ # 061389

Fits Nissan Sentra E/EX 1991-94.

Mfg # ASB16 205 EZ # 043863

Datsun trunk service package - X123 kwy.

KITS

Mfg # ASA16 108 EZ # 074822

Nissan Pathfinder service kit

FACE CAPS - 10 PER PACK

Mfg # ASP16 204 EZ # 001215

Fits most pre-1982 door and trunk locks.

Mfg # ASP16 205 EZ # 001216

Fits most 1982-up door and trunk locks.

Mfg # ASP16 206 EZ # 001217

Black version of ASP16 205.

FACE CAPS - 10 PER PACK (cont'd)

Mfg # ASP16 213 EZ # 067282

1996-up Pathfinder

PARTS ASSORTMENT

Mfg # ASP16 105 EZ # 066444

Nissan lock springs

Mfg # ASP16 161 EZ # 044024

Nissan X123 8-cut wafer #1

Mfg # ASP16 162 EZ # 044025

Nissan X123 8-cut wafer #2

Mfg # ASP16 163 EZ # 044026

Nissan X123 8-cut wafer #3

Mfg # ASP16 164 EZ # 044027

Nissan X123 8-cut wafer #4

DODGE / PLYMOUTH / MITSUBISHI

DOOR LOCKS - CODED

Mfg # ASD22 110 EZ # 001193

Mitsubishi Mirage 1989-92, sedan and hatch, supplied random handed

FACE CAPS (10 PK) AND REPLACEMENT PARTS

Mfg # ASP30 201 EZ # 001262

Fits pre-1981 Colt and Arrow door locks, most pickup door locks, 1979-84 Colt hatchback trunk locks and all Challenger and Sapporo door locks except those with a lighted keyhole

Mfg # ASP30 208 EZ # 001267

Fits 1985-up Mirage, Colt Hatchback and other door/trunk locks, 1987-up pickup door locks and some 1985-up Galant trunk

Mfg # ASP30 209 EZ # 001268

Black version of ASP30 208

Mfg # ASP30 211 EZ # 001270

Similar to ASP30 208 except it has a slightly different shape

FORD IMPORTS

IGNITION SERVICE PACKAGE - UNCODED

Mfg # ASC20 108 EZ # 001136

Fits Capri 90-91 and Tracer 88-90 - X131

DOOR LOCKS - CODED

Mfg # ASD20 101 EZ # 001184

Fits Capri 1990-91, Courier 1977-82, Festiva 1988-91, Tracer 1988-90 - X26/X131 kwy



D-20-101

DOOR PLUG - UNCODED

Mfg # ASD20 301 EZ # 001187

Fits Capri 1990-91, Courier 1982, Festiva 1988-91, Tracer 1988-90 and Probe 1989-90 - X131/X178 kwy



D-20-301



FORD IMPORTS

FACE CAPS - 10 PER PACK

- Mfg # ASP20 201* *EZ # 001239*
Fits early door and trunk lock which use code series 1500-3499
- Mfg # ASP20 206* *EZ # 001244*
Fits door and trunk locks which use code series 3500-6100
- Mfg # ASP20 209* *EZ # 001246*
Fits Probe 1989-90
- Mfg # ASP20 211* *EZ#001247*
Fits door and trunk locks which use code series 6500-7733
- Mfg # ASP20 212* *EZ # 001248*
Black version of ASP20 211

GEO/SUZUKI

IGNITION LOCKS - CODED

- Mfg # ASC24 105* *EZ # 001143*
Fits GEO Spectrum 1986-89
- Mfg # ASC30 118* *EZ # 001160*
Fits Prizm 1989-91



C-24-105

FACE CAPS / SHUTTER - 10 per pack

- Mfg # ASP30 208* *EZ # 001267*
Fits Storm 1990-91 door and Tracker 1989-91 trunk
- Mfg # ASP30 209* *EZ # 001268*
Black version of ASP30 208
- Mfg # ASP30 211* *EZ # 001270*
Fits Storm 1990-91 door and Tracker 1989-91 trunk
- Mfg # ASP30 215* *EZ # 001274*
Black version of ASP30 211

HONDA

IGNITION LOCKS - CODED

- Mfg # ASC19 108* *EZ # 001131*
Fits 1982-89 Accord and 1984-87 Civic - X129 kwy
- Mfg # ASC19 109* *EZ # 001132*
Fits 1983-up Prelude - X128 kwy
- Mfg # ASC19 110* *EZ # 001133*
Fits 1988-89 Civic - X128 kwy
- Mfg # ASC19 111* *EZ # 051159*
Fits 1990-91 Accord - X128 kwy
- Mfg # ASC19 112* *EZ # 061388*
Fits 1992-93 Accord - X128 kwy
- Mfg # ASC19 113* *EZ # 060902*
Fits 1992-up Civic - X128 kwy
- Mfg # ASD19 109* *EZ # 001176*
Honda Accord DX dr. lk.



C-19-108



C-19-109



C-19-110



D-19-110

DOOR LOCKS - CODED

- Mfg # ASD19 110* *EZ # 029323*
Honda Civic 1988-up dr. lk. LH

HONDA

DOOR LOCKS - CODED (cont'd)

- Mfg # ASD19 111* *EZ # 001178*
Honda Civic 1988-91 dr. lk. RH
- Mfg # ASD19 112* *EZ # 051168*
Honda Accord 1990-93 dr. lk. RH
- Mfg # ASD19 113* *EZ # 051169*
Honda Accord 1990-93 dr. lk. LH
- Mfg # ASDP19 110* *EZ # 043989*
Honda Civic 1988-91 pair dr. lk.

DOOR AND TRUNK PLUGS - UNCODED

- Mfg # ASD19 305* *EZ # 040201*
Honda plastic door plug
- Mfg # ASD19 309* *EZ # 001182*
Honda metal plug large face - X128
- Mfg # ASD19 310* *EZ # 001183*
Honda door plug - X172



D-19-309



D-19-310

FACE CAPS - 10 PER PACK

- Mfg # ASP19 202* *EZ # 001228*
Fits 1982-85 Accord door and gas tank door locks
- Mfg # ASP19 215* *EZ # 051184*
Fits 1990-up Honda door lock in handle

TUMBLER

- Mfg # ASP19 142* *EZ # 067285*
Door tumbler #2
- Mfg # ASP19 143* *EZ # 067286*
Door tumbler #3
- Mfg # ASP19 144* *EZ # 067287*
Door tumbler #4
- Mfg # ASP19 145* *EZ # 067288*
Door tumbler #5
- Mfg # ASP19 146* *EZ # 067289*
Door tumbler #6

HYUNDAI

FACE CAPS - 10 PER PACK

- ASP30 201...EZ # 001262*
Fits Excel Sedan 90-94 trunk

INFINITI (by Nissan)

IGNITION LOCKS - CODED

- ASC16 127...EZ # 001125*
Fits G20, M30
- ASD16 106...EZ # 001170*
Fits G20



C-16-127

DOOR AND TRUNK PLUGS - UNCODED

- ASB16 305...EZ # 001097*
Fits G20



Infiniti (by Nissan) - Toyota

INFINITI (by Nissan) (cont'd)

TRUNK LOCKS - CODED

ASB16 105...EZ # 001092
Fits G20

FACE CAPS - 10 PER PACK

ASP16 205...EZ # 001216
Fits G20 door and trunk locks

ISUZU

IGNITION LOCKS

ASC24 107...EZ # 067237
Fits most 1992-94

FACE CAPS - 10 PER PACK

ASP30 202...EZ # 001263
Fits most door locks except 1985-up I-Mark and Spectrum

ASP30 208...EZ # 001267
Fits 1985-up I-Mark and Spectrum door locks

ASP30 209...EZ # 001268
Black version of ASP30 208

MAZDA

IGNITION LOCKS - CODED

Mfg # ASC20 208 EZ # 001138
Fits 1983-up models which use SL10 style lock.

Mfg # ASC20 311 EZ # 067236
Fits X131 88-92



C-20-208

IGNITION SERVICE PACKAGE UNCODED

Mfg # ASC20 108 EZ # 001136
Fits 1983-up ignition locks - X131 kwy.

DOOR LOCKS - CODED

Mfg # ASD20 101 EZ # 001184
Fits most models - X26/X131 kwy

Mfg # ASDP20 101 EZ # 043990
Keyed alike pair of D-20-101.

Mfg # ASD20 110 EZ # 001186
Fits 1990-91 323 two-door hatch & Protege - X188/MAZ13 kwy



D-20-101

DOOR AND TRUNK PLUGS - UNCODED

Mfg # ASD20 301 EZ # 001187
Fits most door and some trunk locks - X26/X131 kwy

Mfg # ASD20 310 EZ # 001189
Door plug - X188 kwy



D-20-301

FACE CAPS - 10 PER PACK

Mfg # ASP20 201 EZ # 001239
Fits early door/trunk locks which use the code series 1500-3499

Mfg # ASP20 204 EZ # 001242
Fits later 70's door/trunk locks.

FACE CAPS - 10 PER PACK

Mfg # ASP20 206 EZ # 001244
Fits door and trunk locks which use code series 3500-6100
Note: if this cap is too small try P-20-211

Mfg # ASP20 211 EZ # 001247
Fits door and trunk locks which use code series 6500-7733

Mfg # ASP20 212 EZ # 001248
Black version of ASP20 211

Mfg # ASP20 216 EZ # 001249
Mazda 90-up (black).

Mfg # ASP20 217 EZ # 044067
Chrome version of P-20-216.

Mfg # ASP20 218 EZ # 067290
Mazda face cap protector

TUMBLERS

Mfg # ASP20 162 EZ # 044060
#2 tumbler

Mfg # ASP20 164 EZ # 044062
#4 tumbler

PONTIAC LeMANS

Mfg # ASD23 208 EZ # 043961
Pontiac LeMans door lock service package

SUBARU

IGNITION LOCKS - CODED

Mfg # ASC16 106 EZ # 001117
Long type - X6 kwy - about 4/5" long



C-16-106

DOOR LOCKS - CODED

Mfg # ASD16 106 EZ # 001170
Fits most 1975-89

Mfg # ASD29 106 EZ # 043965
Fits Legacy 1990-up - LH

DOOR AND TRUNK LOCK PLUGS - UNCODED

Mfg # ASB16 305 EZ # 001097
Used on 1985-up door and trunk locks except Brat and standard hatchback models - X123 keyway

FACE CAPS - 10 PER PACK

Mfg # ASP16 205 EZ # 001216
Fits most 1976-up door locks

Mfg # ASP16 206 EZ # 001217
Black version of ASP16 205



B-16-305

TOYOTA

IGNITION LOCKS - CODED

Mfg # ASC30 103 EZ # 001147
Fits 1975-79 Corolla and Celica*, 1979-83 pickups w/locking columns, 1981-up Starlet, 1979-82 Tercel



TOYOTA (cont'd)

IGNITION LOCKS - CODED (cont'd)

Mfg # ASC30 106 EZ # 001150

Fits many 1983-up models - X37 kwy

Mfg # ASC30 107 EZ # 001151

Fits 1984-87 (Nova) Corolla, 1983-86 Tercel, 1987-88 Tercel wagon, 1985-86 MR2 - X137 kwy

Mfg # ASC30 108 EZ # 001152

Fits 1980-83 Corolla - T80R kwy

Mfg # ASC30 110 EZ # 001154

Fits 1984-87 pickup, 4-Runner - X137 kwy

Mfg # ASC30 115 EZ # 001157

Fits 1985-86 Cressida - X37 kwy.

Mfg # ASC30 116 EZ # 001158

Fits 1987-91 Camry and 1987-88 Cressida - X37/TOY11 kwy

Mfg # ASC30 117 EZ # 001159

Fits 1984-87 Van wagon - TOY32R/TR38 keyway

Mfg # ASC30 118 EZ # 001160

Fits Corolla 1988-91

Mfg # ASC30 119 EZ # 001161

Ignition lock for 86-89 Celica Coupe, 86-91 Supra, 87-90 Tercel Sedan, 87-90 MR2, 88 Chev Nova - X137

Mfg # ASC30 120 EZ # 001162

Toyota 89-93 P/U

Mfg # ASC30 129 EZ # 061385

Fits Camry 1992-95, sedan and wagon.

Mfg # ASC30 130 EZ # 060889

Fits Corolla (except wagon) 1993-95 made in Japan w/o tilt steering.

Mfg # ASC30 131 EZ # 060890

Fits Corolla (except wagon) 1993-95 made in Japan & USA with tilt steering.

Mfg # ASC30 139 EZ # 060901

Fits Celica 1990-93.

Mfg # ASC30 140 EZ # 071602

Fits Tacoma

Mfg # ASC30 142 EZ # 071544

Fits Avalon



C-30-103



C-30-107



C-30-110



C-30-115



C-30-117



C-30-118

SERVICE PACKAGES AND PARTS

Mfg # ASP30 141 EZ # 030104

Tumbler #1 for A-30-104 repair kit.(25 pk)

Mfg # ASP30 142 EZ # 030103

Tumbler #2 for A-30-104 repair kit.(25 pk)

Mfg # ASP30 143...EZ # 030113

Tumbler #3 for A-30-104 repair kit.(25 pk)

Mfg # ASP30 144 EZ # 030102

Tumbler #4 for A-30-104 repair kit.(25 pk)

Mfg # ASP30 161 EZ # 044073

Wafer #1, X174 & X176

Mfg # ASP30 162 EZ # 051188

Wafer #2, X174 & X176

SERVICE PACKAGES AND PARTS (cont'd)

Mfg # ASP30 163 EZ # 044074

Wafer #3, X174 & X176

Mfg # ASP30 164 EZ # 067806

Wafer #4, X174 & X176

Mfg # ASP30 181 Full wafer #1 EZ # 070785

Mfg # ASP30 182 Full wafer #2 EZ # 070786

Mfg # ASP30 183 Full wafer #3 EZ # 070787

Mfg # ASP30 184 Full wafer #4 EZ # 072487

Mfg # ASP30 185 Split wafer #1 EZ # 070788

Mfg # ASP30 186 Split wafer #2 EZ # 070789

Mfg # ASP30 187 Split wafer #3 EZ # 070790

Mfg # ASP30 188 Split wafer #4 EZ # 072488

DOOR LOCKS - CODED

Mfg # ASD30 104 EZ # 001196

Fits any 1978-82 models - T80R kwy.

Mfg # ASD30 106 EZ # 001197

Fits 1984-87 Corolla, 1984-89 4 Runner, 1984-88 pickups, 1983-86 Tercel, 1987-88 Tercel wagon and 1984-90 Van Wagon (has different kwy than original) - X137 kwy

Mfg # ASD30 108 EZ # 001199

Corolla 1988-92

Mfg # ASDP30 106 EZ # 043996

Keyed alike pair of D-30-106 - X137 kwy.

Mfg # ASD30 107 EZ # 001198

Fits 1985-88 Cressida except locks w/lighted keyhole

Mfg # ASDP30 107 EZ # 043997

Keyed alike pair of D-30-107 - X137.

Mfg # ASDP30 108 EZ # 043998

Keyed pair of Corolla 1988-92 (except wagon).

Mfg # ASD30 109 EZ # 043968

Fits Camry 1992 door lock (left hand).

Mfg # ASD30 110 EZ # 043969

Fits Camry 1992 door lock (right hand).

Mfg # ASD30 112 EZ # 043970

Fits Pickup 1989-93.

Mfg # ASD30 114 EZ # 060892

Fits Corolla 1993-94 (right hand).

Mfg # ASD30 115 EZ # 060893

Fits Corolla 1993-94 (left hand).



D-30-104



D-30-106

DOOR AND TRUNK PLUGS- UNCODED

Mfg # ASB30 132 EZ # 030360

Trunk Lk. 88-92 Corolla

Mfg # ASB30 133 EZ # 030359

Toyota 88-92 Trunk Lk. x 174



B-30-126

TRUNK LOCKS - CODED

Mfg # ASB30 126 EZ # 001105

Fits many 1983-up models - T80R/X137 kwy.

Mfg # ASB30 127 EZ # 001106

Fits Camry Sedan 1983-86



B-30-127



Keying Keys • Miscellaneous Parts

TRUNK LOCKS - CODED (cont'd)

Mfg # **ASB30 129** EZ # **001108**
Fits 1988-90 Camry - X37/X159 kwy

FACE CAPS - 10 PER PACK

Mfg # **ASP30 201** EZ # **001262**
Fits most pre-1983 door and trunk locks.

Mfg # **ASP30 202** EZ # **001263**
Fits some 1975-83 Celica, Corolla and Cressida trunk locks.

Mfg # **ASP30 205** EZ # **001265**
Fits 1984-up door locks w/lighted keyhole.

Mfg # **ASP30 206** EZ # **001266**
Black version of ASP30 201.

Mfg # **ASP30 208** EZ # **001267**
Fits most 1983-up door and trunk locks.

Mfg # **ASP30 209** EZ # **001268**
Black version of ASP30 208.

Mfg # **ASP30 211** EZ # **001270**
Similar to ASP30 208 except it has a slightly different shape.

Mfg # **ASP30 215** EZ # **001274**
Black version of ASP30-211.

Mfg # **ASP30 216** EZ # **001275**
Face cap with light.

Mfg # **ASP30 217** EZ # **001276**
30mm dia. face cap.

Mfg # **ASP30 218** EZ # **001277**
Black version ASP30 217.

Mfg # **ASP30 220** EZ # **029648**
Cap for luggage lock

VOLKSWAGEN

IGNITION LOCKS - CODED

Mfg # **ASC31 104** EZ # **001166**
Fits 1971-up 411, 412, Rabbit, Golf, Scirocco, Jetta, Quantum, and GTI and 1978-up Dasher - X9/X88 kwy.

FACE CAPS - 10 PER PACK

Mfg # **ASP31 610** EZ # **060875**
Ignition cap.



C-31-104

VOLVO

FACE CAPS - 10 PER PACK

Mfg # **ASP32 201** EZ # **026153**
Fits 1978-up doors & 1979-up trunks. cover, shutter, & spring.

KEYING KITS

Car	Key Profiles	Mfg. #	EZ #
Datsun/Nissan	X123, X124	ASA16 106	029318
Geo	X184, X192	ASA30 106	001081
Isuzu	X184	ASA30 106	001081
Mitsubishi	X176	ASA30 106	001081
Saturn	All Saturn	ASA49 101	067230
Suzuki	X185	ASA30 106	001081
Toyota	X174	ASA30 106	001081
Toyota	X217	ASA30 108	001083

DUST COVER & SHUTTER PARTS

Mfg # **ASP20 231** EZ # **001250**
For Mazda, Ford Courier, Festiva, Probe, Mercury Tracer, and others. Package cont. 5 each dust cover, shutter, & spring

Mfg # **ASP20 232** EZ # **001251**
Same as P20 231 except black colored dust cover

Mfg # **ASP20 233** EZ # **001252**
Same as P20 231 except plastic shutter for locks with lighted keyhole

Mfg # **ASP20 234** EZ # **001253**
Toyota Tercel 83-90, Camry 83-91, Corolla 84-87, Cressida 85-88, also fits Mitsubishi, Chevy Nova, and models using narrow key profiles

Mfg # **ASP20 235** EZ # **051186**
Ford Escort 96, Ford Probe 93-97, Mazda 323 90-94, Miata 89-98

Mfg # **ASP20 236** EZ # **061369**
Chrome trim, For Mazda 323 95-96, 626 93-97, 929 92-95, Miata 89-98, MPV 89-99, MX3 92-95, MX6 93-96 & RX7 93-95

Mfg # **ASP30 237** EZ # **001282**
For Diamante 92-97, Galant 88-98, Toyota Corolla 4-WD station wagon, Toyota Corolla Coupe/Sedan 88-92, 4-Runner 90-95

COMBINATION KEYING KITS

Mfg # **ASA16 100** EZ # **028552**
Nissan/Datsun kit, tumblers and springs found in keying kits no. ASA16 104, ASA16 105, and ASA16 106

Mfg # **ASA19 100** EZ # **001069**
Honda/Acura kit, tumblers and springs found in keying kits no. ASA19 101, ASA19 102, ASA19 103, ASA19 104

Mfg # **ASA30 150** EZ # **001084**
Contains tumblers & springs from the following kits: A-24-101, A-30-104, A-30-105, A-30-106 & A-30-107. No other service parts included. Used for locks on these keyways: T80R, T80S, T80V, T18A, T81B, TOY32R, X15, X37, X46, X54, X84, X121, X137, X143, X 145, X146, X151, X159, X160, X161, X174, X176, X180, X184, & X186.

Mfg # **ASA41 150** EZ # **074821**
GM/Saturn kit contains all tumblers in the following kits: A-41-103, A-41-104, A-41-105, A-41-106, and A-49-101.

Mfg # **ASA42 150** EZ # **062335**
Ford kit, tumblers from following kits: P-42-121 to P-42-125, P-42-131 to P-42-135, P-42-141 to P-42-145, P-42-161 to P-42-165, P-42-171 to P-42-175, P-42-191 to P-42-195, Spings: P-42-140, P-42-130, P-42-190

PARTS & ACCESSORIES

Mfg # **ASA00 202** EZ # **028733**
Imported car face cap assortment with 1, 2 or 3 ea. of 87 different caps.

Mfg # **ASF00 501** EZ # **001213**
Auto-sec. threaded bolt.

Mfg # **ASAUTOTEL CD** EZ # **077056**
Vehicle database includes: keying kits, ignition, door & trunk locks, facecaps, keyblank crosses, footnotes, prices, labor times and more!

Mfg # **AST CODE** EZ # **080578**
Transponder machine.

Mfg # **AST CODE1H** EZ # **080579**
Honda update.

Mfg # **ASTB2003** EZ # **080391**
Transponder book 2003



AST CODE

ASSA – High Security locks and cylinders for all size locksmiths. Featuring a large variety of exclusive keyways, flexible inventory and patent-protected key control.

Key Cutting - Key design and tolerances shall allow cutting of keys with standard code or duplication machines. The use of single purpose or keyway-specific machines shall not be required or allowed.

Key Control - Both cylinders and keyblanks shall be protected from unauthorized manufacture and distribution by the manufacturers' unexpired U.S. utility patents. Manufacturer shall produce copies of unexpired patents upon demand.

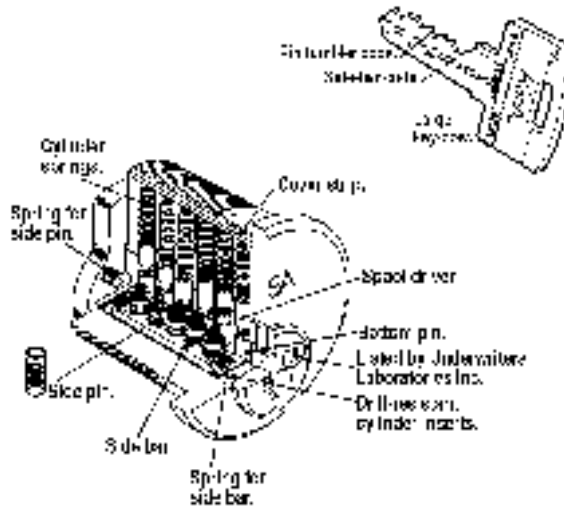

ASSA Twin Exclusive (TE) Cylinder Programs

New Dealer Local (TEL) – Locksmith is assigned one sidebar (4 key sections) for a smaller geographical area. This keyway is shared within the state, or region, with other dealers. Purchase requirement is \$2,500 in saleable merchandise

New Dealer Regional (TER) - Locksmith is assigned one sidebar (4 key sections) and one or more states as their operating boundary. The side coded key blanks will not be reassigned in that region. Purchase requirement is \$4,500 in saleable merchandise.

Existing Dealer Local (TEL) – Same as new dealer, however the purchase requirement is \$250 in saleable merchandise.

Existing Dealer Regional (TER) – Same as new dealer, however the purchase requirement is \$750 in saleable merchandise.

ASSA V-10

Cylinders are high security, standard and/or interchangeable core, manufactured to precision tolerances and the highest quality standards. They have two independent locking mechanisms, operated by a single key, and are manufactured from solid brass extrusions or bar stock. The cylinders also retrofit commercial cylindrical and mortise locksets from: Arrow, Corbin/Russwin, Falcon, Sargent, Schlage, Weiser and Yale.

Pick resistance - Cylinder incorporates two or more independent locking mechanisms, including: Pin tumbler design with six pin chambers. Mushroom shaped driver pins provided in all pin chambers. In addition, pin chambers in the cylinder plug are counter-milled to engage the lip of a mushroom pin in a picking attempt. Key cutting depth tolerances will be +0.00", -0.0016". Coded sidebar locking mechanism will operate independently of pin tumbler device. Sidebar is milled from nickel silver, and physically capable of at least 2,500 different combinations, operated by five coded sidepins. Sidebars are reversible and Sidepins provide additional resistance in the form of false grooves for sidebar around each pin.

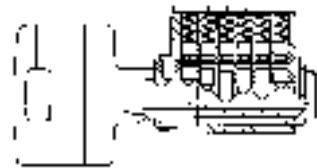

New Dealer Local (C2L) – Locksmith is assigned one sidebar (2 key sections) for a smaller geographical area. This keyway is shared within the state, or region, with other dealers. Purchase requirement is \$1,500 in saleable merchandise

New Dealer Regional (C2R) - Locksmith is assigned one sidebar (2 key sections) and one or more states as their operating boundary. The side coded key blanks will not be reassigned in that region. Purchase requirement is \$3,500 in saleable merchandise.

Existing Dealer Local (C2L) – Same as new dealer, however the purchase requirement is \$500 in saleable merchandise.

Existing Dealer Regional (C2R) – Same as new dealer, however the purchase requirement is \$1,500 in saleable merchandise.



Key Control Accessories

- Cylinder housing and inner plug are high-quality brass.
- Precision machining insures smooth, positive operation and extended cylinder life.
- Case-hardened drill-resistant inserts are embedded in the cylinder plug and housing. (meets UL 437 standards)
- Twin V-10 & 6000 cylinders have 2 independent shear lines that assure optimum pick resistance.



All Keyed cylinders are stocked with Delta Sidebar.

All other cylinders are stocked sub-assembled, without Sidebar.

SNS - Sub-Assembled / No Sidebar

65691 Arrow

Standard and Heavy Duty, 6-pin. With three tailpieces KIL Style.

Mfg#	Fin	EZ #
AA65691 626SNS	626	040141
+AAE65691 626SNS	626	077900

+ Twin Exclusive

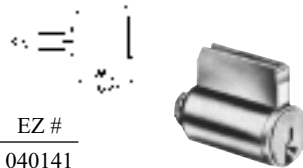

65673 Sargent

Standard Duty 6-Line. KIK, 7 & 10 KIL tailpiece included.

Mfg#	Fin	EZ #
AA65673 626SNS	626	027921
*AAV65673 626SNS	626	064818

* V-10 cylinder

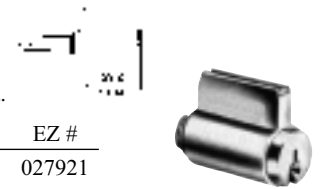

65651 Corbin/Ruswin

Heavy-duty, New style

Mfg#	Fin	EZ #
AA65651 626SNS	626	028636
*AAV65651 626SNS	626	064537

* V-10 cylinder

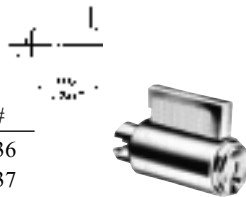

65611 Schlage

Standard and Heavy-Duty 6-Pin, includes cap, pin, spring and 3 length breakoff tailpiece

Mfg#	Fin	EZ #
AA65611 626 126KA2	626	040123
AA65611 626SNS	626	027925
AA65611 SUB62 601 606	606	075280
+AAE65611 626SNS	626	075913
*AAV65611 626SNS	626	060418

* V-10 cylinder + Twin Exclusive

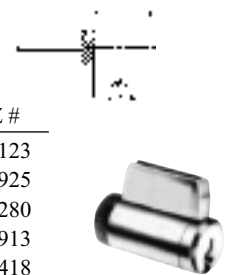

65652 Corbin/Ruswin

Standard Duty. New Style; with tailpiece.

Mfg#	Fin	EZ #
AA65652 626SNS	626	026145

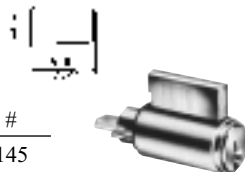

Pin Kits

Pin kit includes 100 pieces of each size bottom, master and driver pins, 500 driver springs, 100 closer strips, 100 each sidepin and sidebar springs, 100 cam screws, 50 twin side pins, 100 each V-10 sidebar and sidepin springs and 50 V-10 left side pins

Mfg # AAPK1 EZ # 064353



Pin kit includes 50 pieces of each size bottom, master and driver pins, plus 100 tumbler springs.

Mfg # AAPK4 EZ # 026144

65631 Yale

Standard and Heavy Duty. 6 pin.

Mfg#	Fin	EZ #
AA65631 626SNS	626	027924

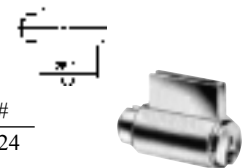

Tools and Accessories

ASSA 6000 cutter wheel for HPC 1200CM 90°/.032"

Mfg # AA869018 EZ # 000150

ASSA 6000 & V-10 code card for HPC 1200CM.

Mfg # AA969020 EZ # 026148

ASSA Spray Lube

Mfg # AA802631 EZ # 063854

Replacement Pins

Contact your IDN representative for replacement pins



Twin 6000 & V-10 Mortise

Rim Cylinders

- ASSA Mortise cylinder can be assembled utilizing one of seven different cams.
- 1 1/8" (6551) housing is universal in that it's manufactured to work both as mortise or rim cylinder. Housing is both threaded mortise and tapped for rim screws. Mortise cams and rim tails have universal fittings.
- 1 1/4" (6552) cylinder housing is not tapped for rim installation.
- Rim cylinder screws and mounting plates are available as an option.



SNS - Sub Assembled, No Sidebar

All Keyed Cylinders are Stocked With Delta Sidebars.

All other Cylinders are stocked Sub-assembled SNS Without Sidebar

Mortise Cylinders

Mfg#	Length	Cam	Finish	EZ #
AA6551 1 605 SNS	1 1/8"	A/R	Bright Brass	040108
AA6551 1 605 126KA2	1 1/8"	A/R	Bright Brass	040110
AA6551 1 624 SNS	1 1/8"	A/R	Dark Oxidized	040111
AA6551 1 624 126KA2	1 1/8"	A/R	Dark Oxidized	000039
AA6551 1 626 SNS	1 1/8"	A/R	Satin Chrome	040105
AA6551 1 626 126KA2	1 1/8"	A/R	Satin Chrome	040106
AA6551 5SUB62 601 626	1 1/8"	Yale	Satin Chrome	075281
AA6551 5 626 SNS	1 1/8"	Yale	Satin Chrome	040114
AA6551 5 626 126KA2	1 1/8"	Yale	Satin Chrome	040113
* AAV6551 1 605SNS	1 1/8"	A/R	Bright Brass	064813
* AAV6551 1 624 SNS	1 1/8"	A/R	Dark Oxidized	060415
+ AAE6551 1 624SNS	1 1/8"	A/R	Dark Oxidized	075911
* AAV6551 1 626SNS	1 1/8"	A/R	Satin Chrome	060416
+ AAE6551 1 626SNS	1 1/8"	A/R	Satin Chrome	075912

* V-10 mortise cylinder + Twin Exclusive

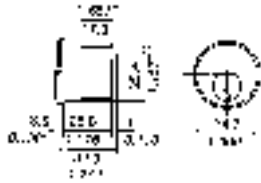

Mfg#	Length	Cam	Finish	EZ #
AA6552 5 605SNS	1 1/4"	Yale	Bright Brass	027927
AA6552 5 626SNS	1 1/4"	Yale	Satin Chrome	027928

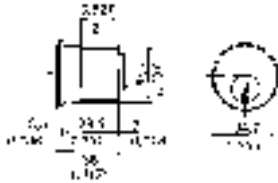

Rim Cylinder Adapters

Converts 1 1/8" 6551 mortise to rim

Mfg # AA867450 EZ # 000124



Cams

Mfg#	Description	EZ #
AA867445	Adams Rite	000121
AA867446	Corbin Cloverleaf	000122
AA872610	Yale	000152
AA867452	Sargent (offset)	000126
AA805412	Segal	028020

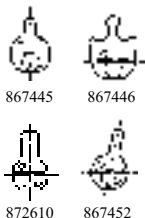

Rim Cylinders

Mfg#	Length	Finish	EZ #
AA6551 H 626 SNS	1 1/8"	Satin Chrome	040116
+ AAE6551H626SNS	1 1/8"	Satin Chrome	077899
AA6551 H 626 126KA	1 1/8"	Satin Chrome	040117
* AAV6551 H 605 SNS	1 1/8"	Bright Brass	064816
* AAV6551 H 626 SNS	1 1/8"	Satin Chrome	060420

* V-10 mortise cylinder + Twin Exclusive



Misc. Parts

Mfg#	Description	EZ #
AA267008 A03	Beta Side Bar	062025
AA267008 008	Beta Side Bar	040097
AA267008 05051	Delta Side Bar	065416
AA267008 038/039	V-10 Side Bar	080573
AA267008 086	Gamma Side Bar	040188
AA267008 126	Delta Side Bar	040096
AA267008 128	Gamma Side Bar	040185
AA267008 130	Gamma Side Bar	040098
AA267008 176	Beta Side Bar	040100
AA267008 300	Delta Side Bar	040184
AA267008 304	Gamma Side Bar	040101
AA267008 360	Gamma Side Bar	040187
AA267008 386	Beta Side Bar	040102
AA267008 108 109	Side Bar	065349
AA267008 220 221	Side Bar	065346
AA267008 224 225	Side Bar	066284
AA267008 505/506	Side Bar	028024
AA353969 626	V-10 Oval Cyl. Plug	064841
AA353969 613	V-10 Oval Cyl. Plug	082012
AA353970 626	1 1/8 Mort. Cyl Plug	064835
AA353978 626	Sch. KIK Plug	064837
AA807164	V-10 Side Bar Springs	064352
AA867065	Cylinder Springs	000085
AA867088	Side Bar Springs	000108
AA867087	Side Pin Springs	000107
AA868141	Mort. & Rim Cov. Strip	000136
AA900209	Rim Cyl. Kit, 1 Plate	000154
AA806268 605	Spacing Ring 1 3/8" door	040142
AA806268 626	Spacing Ring 1 3/8" door	040146

Twin 6000 & V-10 Deadbolts



Twin 6000 & V-10 Padlocks

Tubular Security Deadbolts

Deadbolt – 1” throw; Brass, with saw-resistant insert.
 Lockcase – High-quality tubular bolt assembly.
 Lockfront – 1” x 2 1/4” square corner.
 Strike – 1 1/8” x 2 3/4” security strike.
 All deadbolts stocked sub-assembled, less sidebar

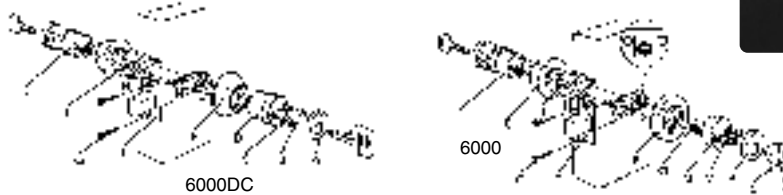
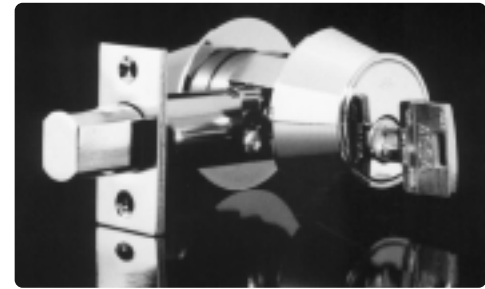

- | | |
|-------------------------|--------------------------|
| A Cyl. & Thumbturn cap | I Hardhat |
| B Ball-bearing insert | J Outside cylinder |
| C Cyl mtg bolts(2-3/4") | K Thumbturn |
| D Inside cylinder | L Thumbturn set screw |
| E Cylinder ring | M Cyl mtg bolts (2-1/4") |
| F Faceplate bolt | N Thumbturn assy |
| G Wood/metal. screws | O Tailpiece bushing |
| H Screw for Hardhat | P Thumbturn ring |

Single Cylinder

Mfg#	Backset	Finish	EZ #
AA6000 605 2 3/8 SNS	2 3/8"	Bright Brass	027916
AA6000 609SNS 2 3/8	2 3/8"	Antique Brass	040103
AA6000 624SNS	2 3/8"	Dark Oxidized	068171
AA6000 626SNS 2 3/4	2 3/4"	Satin Chrome	027918
* AAV6000 605 2 3/4 F SNS	2 3/4"	Bright Brass	060412
* AAV6000 609 2 3/4 SNS	2 3/4"	Antique Brass	069712

Replacement Bolts

Mfg#	Backset	Finish	EZ #
AA907001 626	2 3/4"	626	000177
AA907002 626	2 3/4" Drive-in	626	000178
AA907003 605	2 3/8"	605	000179
AA907003 626	2 3/8"	626	000181
AA907004 626	2 3/8" Drive-in	626	000182

Double Cylinder

Mfg#	Backset	Finish	EZ #
AA6000DC605 2 3/4 SNS	2 3/4"	Bright Brass	000025
AA6000DC609SNS 2 3/8	2 3/8"	Antique Brass	040104
AA6000DC626SNS 2 3/4	2 3/4"	Satin Chrome	027915
* AAV6000DC605 2 3/4 F SNS	2 3/4"	Bright Brass	064793

* V-10 deadbolt

Padlocks

- Shackle - rustproof, case-hardened steel
- Electroplated Black Chrome-plated finish
- Padlocks are sub-assembled, less sidebar
- Body of brass
- No external rivets or screws
- Weep holes for water drainage



Mfg#	Description	Case Width	Shackle Dia.	Shackle Clearance	EZ #
Non-Key Retaining					
AA65190B SNS	#2 NKR Standard Shackle	1 7/8"	5/16"	1 1/16"	028645
Key Retaining					
AA65191SB SNS	#2 KR Shrouded Shackle	1 7/8"	5/16"	1/2"	040121
AA65191LB SNS	#2 KR Extended Shackle	1 7/8"	5/16"	2 1/16"	000032
AA65191B SNS	#2 KR Standard Shackle	1 7/8"	5/16"	1 1/16"	000031
AA65191B 126 KA2	#3 KR Standard Shackle	1 7/8"	5/16"	1 1/16"	040120
AA65391 SNS	#3 KR Standard Shackle	2 9/16"	7/16"	1 1/4"	040122





600 Series Leversets • Grade 3 Designer

Classic Series • Replacement Latches

600 Series Leversets

- Backset: 2 3/4" backset standard. Optional 2 3/8" backset available. • Vandal resistant clutch levers
- Complies with ANSI A156.2 Series 4000 Grade 2 and ADA accessibility guidelines • 5 year limited warranty
- Cylinder: Solid brass 6 pin cylinder. SC4 keyway standard, WR5 keyway available. Locks will also accept LSDA, Ilco, ASSA, Schlage, and KABA Peaks replacement cylinders.



Mfg#	EZ #	Mfg#	EZ #	Mfg#	EZ #	Mfg#	EZ #	Mfg#	EZ #
<i>Entry</i>		<i>Passage</i>		<i>Privacy</i>		<i>Storeroom</i>		<i>Classroom</i>	
BPL600 3	066029	BPL610 3	066030	BPL620 3	066031	BPL640 3	066032	BPL650 3	066035
BPL600 10	066040	BPL610 10	066041	BPL620 10	066042	BPL640 10	066043	BPL650 10	066044
BPL600 10B	065955	BPL610 10B	065957	BPL620 10B	065959	BPL640 10B	065961	BPL650 10B	066033
BPL600IC10B	065963	BPL610 26D	065958	BPL620 26D	065960	BPL640IC10B	065965	BPL650 26D	066034
BPL600 26D	065956	<i>600 Series Leversets stocked with 2 3/4" latches IC = Less interchangeable core</i>				BPL640 26D	065962	BPL650IC26D	066037
BPL600IC26D	065964					BPL640IC26D	065966		
BPL600 26D LL	084969								

Replacement Latches and Cylinders

Mfg#	Description	EZ #	Mfg#	Description	EZ #
BPCYLC26D	KIK Cyl SC4 Kwy	066066	BP085UL3	2 3/8" UL Deadlatch	066057
BPCYLC3	KIK Cyl SC4 Kwy	066065	BP085UL10	2 3/8" UL Deadlatch	066058
BPCYLW26D	KIK Cyl WR5 Kwy	066068	BP085UL10B	2 3/8" UL Deadlatch	065979
BPCYLW3	KIK Cyl WR5 Kwy	066067	BP085UL32D	2 3/8" UL Deadlatch	065980
BP005 3	2 3/8" Spring latch	066053	BP096UL3	2 3/4" UL Deadlatch	066059
BP005 10	2 3/8" Spring latch	066054	BP096UL10	2 3/4" UL Deadlatch	066060
BP005 32D	2 3/8" Spring latch	065976	BP096UL10B	2 3/4" UL Deadlatch	065981
BP014 10	2 3/4" Spring latch	066056	BP096UL32D	2 3/4" UL Deadlatch	065982
BP014 32D	2 3/4" Spring latch	065978	BP104 26D	2 3/8" RFL	065984
			BP105 26D	2 3/4" RFL	065986

Grade 3 Designer Series

- 1 year finish warranty on standard finishes
- 5 year mechanical warranty
- Lifetime finish warranty on Millennium Brass
- 45° lever rotation retracts latch • Adjustable backset 2 3/8" or 2 3/4"
- Square corner latches and full lip strikes

Mfg#	Func.	EZ #
<i>Egg Shape Knobs</i>		
BP10 TYL MB3W	Entry	079041
BP10TYL 15W	Entry	082767
BP11 TYL MB3	Passage	079042
BP11 TYL 15	Passage	082768
BP12 TYL MB3	Privacy	079043
BP12 TYL 15	Privacy	082769
<i>Levers</i>		
BP50LA LH MB3W	Entry	078976
BP50LA RH MB3W	Entry	078982
BP50LA LH 15W	Entry	082755
BP50LA RH 15W	Entry	082754
BP51LA LH MB3	Passage	078988
BP51LA RH MB3	Passage	078992
BP51LA LH 15	Passage	078989
BP51LA RH 15	Passage	078993
BP52LA LH MB3	Privacy	078996
BP52LA RH MB3	Privacy	079000
BP52LA LH 15	Privacy	078997
BP52LA RH 15	Privacy	079001



TYL Design



LA Design

MB3 = Millennium Polished Brass
15 = Antique Nickel
W = WR5 Keyway

Classic Series

- Grade 3 security • KW1 keyway
- 1 year finish / 5 year mechanical warranty

Mfg#	Function	EZ #
<i>Knobs with adjustable backset</i>		
BP70C3	Entry	074186
BP70C3RCL	Entry	074189
BP70C3RCL VP	Entry	084119
BP70C5RCL	Entry	074239
BP71C3	Passage	074187
BP71C3RCL	Passage	074190
BP71C3RCL VP	Passage	084125
BP71C5RCL	Passage	074240
BP72C3	Privacy	074188
BP72C3RCL	Privacy	074191
BP72C3RCL VP	Privacy	084122
BP72C5RCL	Privacy	074241



Mfg#	EZ #
<i>Single Cylinder Deadbolts</i>	
BP75 3	075374
BP75C3RCL VP	084128
BP75 5	075375
<i>Double Cylinder Deadbolts</i>	
BP78 3	075378
BP75C3RCL VP	084131
BP78 5	075380



Adjustable Latches
Mfg # BP9075N3 EZ # 074225
Mfg # BP9075N5 EZ # 074244
Mfg # BP9076N3 EZ # 074226
Mfg # BP9076N5 EZ # 074245

Stocked Round Corner



FORD - IGNITION LOCKS

Mfg # AKH96PT EZ # 077245
Ford Mercury with Transponder

AKLC1340



Mfg # AKLC1340 EZ # 071445
Contour/Mystique 1995-97

AKLC1400



Mfg # AKLC1340U EZ # 071431
1340 uncoded

Mfg # AKLC1400 EZ # 071430
1938-1966

AKLC1401



Mfg # AKLC1401 EZ # 000422
1960-1977

Mfg # AK1402 EZ # 000423
1965-79

AK1402



Mfg # AKLC1404 EZ # 000425
1970-73

Mfg # AK1405 EZ # 000427
1973-76

AK1405



Mfg # AK1406 EZ # 000429
Column mtd. 2/76 - 1991

AK1406



Mfg # AK1406U EZ # 000430
1406 uncoded

Mfg # AK1407 EZ # 000431
Column mtd. 1978-92

AK1407



Mfg # AK1408 EZ # 025853
Ford Trucks 1981-83

AK1408



Mfg # AK1410 EZ # 035048
1983-89

Mfg # AK1411 EZ # 070872
same as 1410 with black chrome finish

AK1410



Mfg # AK1412 EZ # 000433
Taurus/Sable 1986-89

AK1412



Mfg # AK1412U EZ # 000434
1412 uncoded

Mfg # AK1413 EZ # 000435
T-Bird, Cougar, Cont., Mark 1985-91

AK1413



Mfg # AK1413U EZ # 000436
1413 uncoded

Mfg # AK1414 EZ # 000437
Lincoln, Aerostar 1986-92

AK1414



Mfg # AK1414U EZ # 000438
1414 uncoded

Mfg # AKLC1415 EZ # 029203
Taurus, Sable 10-bit 1990-92

AK1415



Mfg # AKLC1415U EZ # 029204
1415 uncoded

Mfg # AKLC1416 EZ # 000439
Black version of 1415

AKLC1416



Mfg # AKLC1416U EZ # 000440
1416 uncoded

FORD - IGNITION LOCKS

Mfg # AKLC1417 EZ # 030106
1993 - 94 black chrome

AKLC1417



Mfg # AKLC1417U EZ # 051035
1417 uncoded

Mfg # AKLC1418 EZ # 030107
1993 -94 chrome

Mfg # AK1418U EZ # 066635
1418 uncoded

AKLC1438



Mfg # AKLC1438 EZ # 030110
1993 -96

Mfg # AKLC1438U EZ # 051037
1438 uncoded

Mfg # AKLC1439 EZ # 030111
Black version of 1438

AKLC6177



Mfg # AKLC1439U EZ # 051038
1439 uncoded

Mfg # AKLC6177 EZ # 068105
1996-99 w/o PATS

Mfg # AK6177U EZ # 071429
6177 uncoded

AKLC6180



Mfg # AKLC6180 EZ # 068106
1996-99 w/ PATS

FORD - DOOR LOCK SETS

Mfg # AK1549 EZ # 070868
1978-89

AK1550



Mfg # AK1550 EZ # 000475
Ford/Mercury 1965-on

Mfg # AK1551 EZ # 000477
1968-84

AK1551



Mfg # AK1589 EZ # 070870
1981-93

Mfg # AK1591 EZ # 070871
1981- 86

FORD - TRUNK LOCKS

Mfg # AK1552 EZ # 000479
1965-89

AK1589



Mfg # AK1553 EZ # 000481
1973-93

FORD - MISC.

Mfg # AKSK5011 EZ # 071428
Ford 8 Cut service kit.

AK1552



Mfg # AKSK6000 EZ # 000513
Pinning kit for Ford 1965-up door, trunk and ignition locks

Mfg # AKSK6249 EZ # 071435
Ford 8 Cut door & glove box service kit.

Mfg # AKSK6700 EZ # 029200
Service Ford 1965-up door and trunk locks.

Mfg # AKSK7071 EZ # 061937
Ford "Kwik-Kit" 10 Cut service kit.



CHRYSLER - IGNITION LOCKS

Mfg # AKLC1355 EZ # 062276
1993-97



Mfg # AK1355U EZ # 062277
1355 uncoded



Mfg # AK1440 EZ # 070874
Chry 1949-68, Ply 1974 - 84

Mfg # AKLC1444 EZ # 000454
Column mtd., std. steering...1970-71



Mfg # AK1445 EZ # 000456
Column mtd., tilt & tele steering...1972-91



Mfg # AK1445U EZ # 000457
1444 uncoded

Mfg # AK1446 EZ # 000458
Column mtd., std. steering 1972-91 (except imports)



Mfg # AK1448 EZ # 070875
1986-90 (except imports) black chrome



Mfg # AK1449 EZ # 070864
1986-90 (except imports) bright chrome

Mfg # AK1450 EZ # 070865
1986-90 (except imports) for tilt wheel



Mfg # AK1452U EZ # 070866
1990-92



Mfg # AKLC5160 EZ # 071433
Chry 1994-97, Jeep 1990-94



Mfg # AKLC6940 EZ # 071436
Chry and Jeep 1988 & up, uncoded



Mfg # AKLC6940U EZ # 071432
6940 uncoded



CHRYSLER- MISC

Mfg # AKSK6015 EZ # 000514
Service Kit

CHRYSLER - DOOR LOCK SET

Mfg # AK1502 EZ # 000465
1966-on



CHRYSLER - TRUNK LOCKS

Mfg # AK1500 EZ # 000461
Universal - 1966-78



Mfg # AKTL1501 EZ # 000463
Universal - 1973-89

AK1501

GM- IGNITION LOCKS

Mfg # AKLC1353U EZ # 064325
1995-97 uncoded, CSS column light trucks w/auto trans

Mfg # AKLC1354 EZ # 064326
1995-97 uncoded, for CSS column light trucks
w/man. trans



Mfg # AKLC1354U EZ # 064327
1354 uncoded

GM- IGNITION LOCKS

Mfg # AKLC1420 EZ # 000441
1935-65



Mfg # AK1422 EZ # 000443
1966-1986



Mfg # AK1425 EZ # 000446
Locking columns 1969 IHC 1973-80

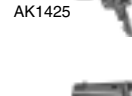

Mfg # AK1426 EZ # 000447
1970 - 78



Mfg # AK1426U EZ # 000448
1426 uncoded

Mfg # AK1427 EZ # 000449
GMC (Column Mtd.) 1984-71



Mfg # AK1428 EZ # 000450
GM 1977-96, AMC/Jeep 1985-93



Mfg # AK1428U EZ # 000451
1428 uncoded

Mfg # AK1430 EZ # 035049
1428 with black chrome finish



Mfg # AKLC1432 EZ # 062412
1989-89

AK1430

Mfg # AKLC1434 EZ # 028768
1986-99 VATS equipped



AK1434

GM - DOOR LOCK SETS

Mfg # AKDL1580UEZ # 025854
1953-96 uncoded

Mfg # AKDL1581U EZ # 000493
1960-82 uncoded

Mfg # AKLS1586 EZ # 000496
1973 & after



AK1580

GM- TRUNK LOCKS

Mfg # AK1574 EZ # 070869
1978-94 tailgate latch

Mfg # AK1575 EZ # 000486
1960-1996 trunk lock

Mfg # AK1575U EZ # 000487
1575 uncoded

Mfg # AK1576 EZ # 000488
Fits on car body

Mfg # AK1576U EZ # 000489
1576 uncoded



AK1575



AK1576

GM- MISC

Mfg # AKA6035 EZ # 000515
Service GM door, trunk and ignition locks

Mfg # AKSK6400 EZ # 062446
GM 10 Cut Service Kit

Mfg # AKA6036 EZ # 000516
GM Chrome Scalp

Mfg # AKRP6520 EZ # 035093
GM black Scalp



Keying Parts & Accessories

V.A.T.S. Decoder – Vehicle Anti-Theft System

The Decoder Performs 4 Basic Functions:

- Identifies correct V.A.T.S. key blank from customer's original.
- Decodes correct V.A.T.S. blank from the vehicle (if original key is lost).
- Diagnoses steering column connection problems and V.A.T.S. computer problems.

Mfg # AKLT7000 EZ # 000405



AKLT7000

V.A.T.S Master Kit

Kit includes: 1 - LT7000 Decoder, 1 - LT7003 Adapter key harness, 5 - LT7004 Single sided adapter keys, 5 - Double sided adapter keys, 15 - Single sided VATS replacement keys, 14 - Double sided VATS replacement keys, 1 - Foam lined plastic case with dual plastic latches and built in hasp, 1 - Three Terminal decoder adapter harness, 1 - Three Terminal diagnostic adapter harness

Mfg # AKLT6855 EZ # 066998



AKLT6855

Single Sided Key Adapter

Set of five replacement key blanks for LT7000.

Mfg # AKA7004 EZ # 028755



AKA7004

Double Sided Key Adapter

Set of 5 double-sided, durable plastic replacement key blanks for LT7000.

Mfg # AKLT7005 EZ # 031188



AKLT7005

Vats Decoder Double Sided Key Adapter

Retrofit all single sided A7000 V.A.T.S. Decoders and other brands to accept double sided keys.

Mfg # AKLT7006 EZ # 031187



AKLT7006

Single & Double Sided Key Adapter Harness Assy.

Eliminate "under the dash" work on virtually all V.A.T.S. jobs. Six plastic, disposable keys (3 sgl, 3 dbl) and a plug-in adapter harness are supplied together with complete instructions for their use.

Mfg # AKLT7007 EZ # 060197



AKLT7007

Vats Key Reader

Sturdy and compact, a single 9 volt battery powers lighted digital display for easy and accurate reading under all conditions.

Mfg # AKLT6534 EZ # 066997



AKLT6534

Vats Key Reader Master Kit

Kit includes: 1 - key reader, 15 - single sided VATS replacement keys, 14 - double sided VATS replacement keys

Mfg # AKLT6932 EZ # 066999



AKLT6932

Vats Harness Adapter

Turns LT7000 into 3-terminal connector for performing under dash decoding of 1997 + Chevrolet Corvettes

Mfg # AKLT6992 EZ # 071434



AKLT6992

A6100

Mfg # AKA6100 EZ # 000404 Services 10 Bitted Ford Ignition Locks.

Replacement Parts for the A6100

Mfg # AKRP6101	Tumbler #1	EZ # 061870	Mfg # AKRP6104	Tumbler #4	EZ # 043598
Mfg # AKRP6102	Tumbler #2	EZ # 043596	Mfg # AKRP6105	Tumbler #5	EZ # 043599
Mfg # AKRP6103	Tumbler #3	EZ # 043597	Mfg # AKRP6106	Tumbler Springs	EZ # 061871
Mfg # AKRP6107	Pin cover	EZ # 043613			

Keying Parts & Accessories

Mfg # AKA6070 EZ # 040035

Everything you need for rekeying and repairing every All-Lock cam lock made. Contains both new AC wafers and standard wafers.

Mfg # AKA6500 EZ # 035092

Domestic "OOPS" Kit - a collection of the most needed (and sometimes hard to find) parts to complete the job.



Oversized Mushroom Exit Switches

Includes oversized 2 3/8" palm button, faceplate, contact block and tamperproof screws.



Mfg#	Description	EZ #
CGCM5020E	2 3/8" Button	060130
CGCM5120E	2 3/8" Button w/ narrow faceplate	068443

Flush Mount Key Switches

Complete unit includes brushed aluminum faceplate, choice of switch, cylinder lock ring, 2 socket/slotted screws and 2 tamperproof screws. Mortise cylinder not included.



Mfg#	Description	EZ #
CGCM1110	Key Switch, SPST Maintained	060147
CGCM1120	Key Switch, SPDT Momentary	060297

Delay Timer

Ultra compact MiniMinder is small enough to fit inside an electrical box, or may be mounted with double sided tape (supplied). Use with N/O momentary switch to activate/deactivate electrical devices for 1-15 seconds. Dimensions .9" x 1.6"



Mfg#	Description	EZ #
CG1000/75	12VDC, 1 AMP SPDT contact	060762

Vandal Resistant Exit Switch

Button is countersunk in a 1/4" thick aluminum faceplate and can withstand extreme attacks of all types. DPDT switch is rated at 3 amps. Faceplate is 2 3/4"



Mfg#	Description	EZ #
CG9080	Single gang faceplate, DPDT momentary	066564

Parts For 1000 Key Switches

Mfg#	Description	EZ #
CG1000 35	SPST maintained contact switch	066566
CG1000 40	SPDT momentary contact switch	066565

Narrow Stile Key Switch

Mullion faceplate is only 1 3/4" wide and can be flush mounted in aluminum door frames.



Mfg#	Description	EZ #
CG2020	Narrow key switch, SPDT momentary	066567

Remote Release Switch

Surface mount, weather resistant aluminum box with panel mounted rocker switch. Brushed aluminum finish

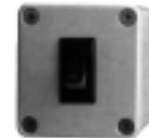

Mfg#	Description	EZ #
CG810	SPDT momentary	066570
CG820	SPST maintained	066571

2" Square Illuminated Exit Switch

- Stainless steel
- Single gang faceplate



Mfg#	Description	EZ #
CGCM30E	SPDT momentary	069443

Economy Exit Switch

Designed for narrow stile mounting. Features a 1" red SPDT button, rated 15 amps @ 125V.



Mfg#	Description	EZ #
CG250 7	SPDT momentary, with push to exit logo	066568

Emergency Door Release

Mfg#	EZ #
CGCM702	071125



Proximity Card Readers

SmartLock® Pro System

This entry-level system utilizes single door controllers and very easy to use software with an “Outlook” style interface. Each controller is equipped with three Form “C” relay outputs. One to control an electric lock, and two additional outputs that can be configured to control a power door operator, and/or provide a means to annunciate forced entry/door held open conditions.

Voiding and validating cards is easily done by using the SmartLock Pro software. With the easy to use software you can set up the cardholder database on a PC utilizing programmable access schedules and access profiles. The access profile defines the readers and time intervals that the user is allowed access.

The CanLan TCP/IP Controller is a cost-effective solution that makes it easy to network-enable the SmartLock door controllers over an existing ethernet network. If the system is dial-up, you must use one CLA50 communications line driver at each remote end.



SmartLock Pro controller



TCP/IP controller

Mfg #	Desc	EZ #
KZCA SLPC	SmartLock Pro controller	084859
KZCA CLA50	Communications line driver	082973
KZCA SLCD	SmartLock software	084863
KZCA CANLAN	TCP/IP controller	082974

SmartLock® Pro System

- 60 door / 120 reader capacity
- 4800 user capacity
- Auto door unlock schedules
- Real time system with alarms
- Programmable holidays, access schedules & access templates

Sentinel Prox Readers

- 4” to 5 ½” read range
- Industry standard Wiegand output
- Metal Compensated
- Mullion Mounting
- AWID’s Lifetime Warranty
- UL294 listed
- 5 - 12 VDC

Mfg# KZAW SR2400 EZ# 084860



Accessories

Mfg #	Desc	EZ #
KZAW PROXCSSOL	Prox Card	084861
KZAWPROXKTSOL	Prox Key Fob	084862

Finger Print Readers

- Fingerprint Only .. No Card Required!
- 90 User/Template Capacity
- No PC or Software Required
- Add/Delete Users with Portable Hand-Held Programmer
- Separate Door Controller for Increased Security

Mfg# KZCASUBZODL EZ# 085601



Accessories

Mfg #	Desc	EZ #
KZCAZODLPKIT	Zodiac Programmer	082963
KZCAZODHEATER	Zodiac Heater Kit	082967
KZCAZODCOVER	Zodiac Flip-Up Cover	082966



Zodiac Programmer



Sesame® Keyless Padlocks

K436/K437

Solid brass body. Built to resist even tough marine environments.

- 10,000 resettable combinations
- Hardened steel shackle
- Solid brass, double locking mechanism



Mfg#	Shackle	Body	EZ #
CCK436	1" x 5/16"	1 7/8" x 1 11/16"	002314
CCK437	2 1/4" x 5/16"	1 7/8" x 1 11/16"	002391

K500

Heavy duty pressure cast body, black epoxy finish.

- 10,000 resettable combinations
- Hardened steel shackle
- Solid brass, double locking mechanism



Mfg#	Shackle	Body	EZ #
CCK500 3/4	1" x 5/16"	1 7/8" x 1 11/16"	002317
CCK500 2 1/4	2 1/4" x 5/16"	1 7/8" x 1 11/16"	002316

SearchAlert™ Combination Padlock

- Lets you know when your luggage was inspected at the airport. Green = lock not opened, Red = lock was opened
- Lifetime guarantee



Mfg#	Desc.	EZ #
CCKN7400PSB	Black	082724
CCKN7400BN	Nickle	082726



Panel Lock

Self latching – retracts by lifting up on lever.

Mfg#	EZ #
CC15767LH26D KA CAT60	026217
CC15767RH26D KA CAT45	002381



RH Shown

Disc Tumbler Drawer Locks

Application: 7/8" diameter hole

Mfg #	Mat. Thick	EZ #
<i>02065 Drawer Lock - Dead Bolt</i>		
CC02065 7/8 4KD	7/8"	002333
CC02065KACAT30 4	7/8"	043150
<i>02065 1/2 Drawer Lock - Latch</i>		
CC02065 1/2 CAT30 4	7/8"	026208
CC02065 1/2 7/8 4KD	7/8"	002331
<i>02066 Drawer Lock - Dead Bolt</i>		
CC02066 3/4 4KA	3/4"	040268
CC02066 7/8 4KA CAT30	7/8"	002335
CC02066 7/8 4KD	7/8"	002343
CC02066 1 1/8 4KA CAT30	1 1/8"	026209



02065 Drawer Lock Dead Bolt



02065 1/2 Drawer Lock Latch



02066 Drawer Lock Dead Bolt

Sliding Door Lock

- Pin tumbler
- Can be masterkeyed
- Operation: push bolt type, to lock push end of cylinder, to unlock, use key
- Material: all brass finish US 4 standard.
- Strike: No. 02290S brass, regularly furnished

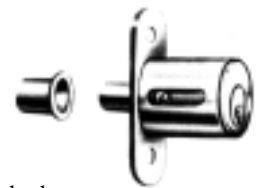

For 7/8" Thick Material

Mfg#	EZ #
CC02290KA4T642	040269
CC02290KD	040271

Original Key Blanks

Mfg#	EZ #
CC5865JVR	002395

Chicago's 4 pin tumbler filing cabinet locks are made with a die cast barrel and bolt. All locks are plated in satin chrome.



EXP-19 Round-Bolt 1 1/2" length

Mfg # CHEXP19KD EZ # 002418
Mfg # CHEXP19KA5X75 EZ # 002417



5001-LP Round-Bolt 1 3/4" length

Mfg # CH5001KD EZ # 002528
Mfg # CH5001KA1X20 EZ # 002527

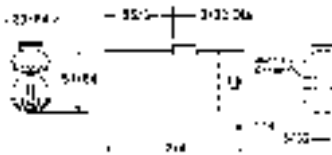

5001-50 Round-Bolt 1 3/4" length

Mfg # CH5001 50KD EZ # 002530
Mfg # CH5001 50KA1X20 EZ # 002529



5002 Rectangular-Bolt 2" length

Mfg # CH5002KD EZ # 002534
Mfg # CH5002KA EZ# 040237

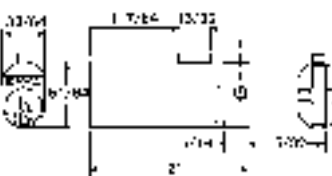

Series 1974/1975 Drawer Lock

Five disc tumbler removable plug and bolt in 3/4" dia. die cast barrel with two flats 5/8" across. Bolts are steel with 1 1/32" throw. 1974 bolt is 53/64" x 1 1/64". 1975 bolt is 5/8" x 5/32". Both locks are plated in satin chrome.

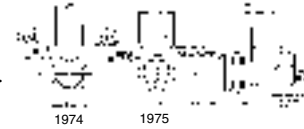

Mfg #	EZ #
CH1974KD	002485
CH1974KA1289	026186
CH1975KD	002489
CH1975KA1289	026188



Series 1804/3186 Double Bitted Cam Lock

Eleven criss-cross blade tumbler plug in 3/4" diameter. Die cast barrel with two flats - 5/8" across. Key and cam rotation 90 degree from locked to unlocked position with keypull in locked position only. Straight cam furnished is 1/8" thick, 3/4" wide. Standard finish - Polished Nickel.



Mfg#	Cyl. Length	EZ#
CH1804KA 2001	1 1/2"	040241
CH3186KA	5/8"	040229

Series 1704 Single Bitted Cam Lock

Five disc tumbler plug in 3/4" diameter. Die cast barrel with two flats - 5/8" across. Key and cam rotation 90° from locked to unlocked position with keypull in locked position only. Straight cam furnished is 1/8" thick x 3/4" wide. Standard finish - Polished Nickel.



Mfg#	Cyl. Length	EZ#
CH1704KA1289	1 1/2"	040238

Series 4073 Switch Lock

Patented Ace II lock assembly. Switches are U.L. recognized. Maintaining contact switch operated by manually rotating inserted key 90° clockwise from open to closed position. Key removable in two positions.

Mfg	EZ#
CH4073 2KD	040230





Key Blanks & Accessories

Double Bitted Switch Locks

Single Pole, Single Throw. Eleven criss-cross blade tumbler plug in 3/4" dia. barrel with one flat .700" across. Barrels are plated in bright chrome. Switches are U.L. Recognized



- 2174-1: "A" - 1 9/16" Key removable in off position
- 2174-2: "A" - 1 9/16" Key removable in 2 positions
- 2174-70: "A" - 1 13/16" Key removable in off position

Mfg#	EZ #
Maintaining Contact	
CH2174 1KD	002494
CH2174 1KA	040228
CH2174 2KA2001	026190
Momentary Contact	
CH2174 70KD	002498
CH2174 70KA2001	026191
NLC2174 70DC KA2007	083610

Drawer Lock

Bolt Type. Five disc tumbler. Removable plug feature. Steel locking bolt. Two keys furnished per lock. Standard finish - Brushed Brass.

Cylinder 1968: 7/8" dia., 7/8" long

Mfg#	EZ#
CH1968KA1289	040245
CH1968KD	040242



Key Blanks

Mfg#	EZ #	Mfg#	EZ #
CHK2W	002441	CHK102H	002434
CHK4W	002458	CHK103H	002436
CHK4	002450	CHK104H	002438
CHK5	002463	CHKP1	002420
CHK9	002466	CHKP2	002424
CHK35	002445	CHKP3	002425
CHK100MH	002430	CHKP4	002426
CHK101H	002432	CHKP9	002428

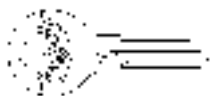

K-101-H

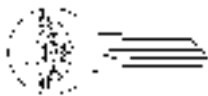

K-102-H

ACE II Seven Pin Tumbler Screw Type

Patented Ace II lock assembly in 3/4" diameter barrel with two flats - 5/8" across. 360 degree key rotation with keypull every 180 degrees. Two keys furnished per lock. Includes body nut.

"A" Dim = 7 1/32" with 18 or 24 thread

Mfg#	EZ#
CH4107 18KA	040231
CH4107 18KD	040232
CH4107 24KA	040234
CH4107 24KD	040233



Ace II Cam Lock

Patented Ace II assembly. All brass construction. Center plug contains anti-drill pin for added security. Stop cams are now provided in 90 degree or 180 degree rotation. Standard Finish - Polished Nickel. Furnished with straight locking cams which can be mounted vertically or horizontally. Two keys furnished



Mfg#	Cyl. Length	EZ#
CH4152KA 7302	15/16"	040246
CH4152KD	15/16"	002518
CH4153KA PL505	11/16"	040247
CH4153KD	11/16"	002520
CH4160KA 6502	1 3/32"	040236

Locking Handle

Features a removable plug. 1/4" studs regularly furnished with 1 13/16" mounting centers and 8-32 studs with 1 1/2" centers.

Mfg # CH75 121 EZ #002537
1 13/16" c.c.

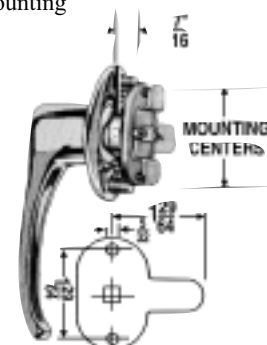



Multi-Function Switch Locks

Misc. Locks and Key Blanks

MFSW3-1138 Series Switch Locks

Provides three different locking functions:

- 1 key pull at 12:00 only
- 2 key pulls at 12:00 or 3:00
- Momentary contact switch with - spring back - 12:00 key removable



3 wire switch assembled to lock may be adapted as follows:

- When all 3 wires are used - switch is single pole double throw
- When 2 wires are used - switch is single pole single throw - normally open or closed
- The 3-10" lead wires & connectors may be cut to size
- Switch is U.L. & CSA listed - rated for 7AMPS 125/250VAC

Mfg # FOMFSW3 1138KA27379 EZ # 003823

Mfg # FOMFSW3 1138KD EZ # 026358

YPT1010 Pop-Out "T" Handle Cylinder

Gem 7 Pin Tumbler Cylinder

When key combination change is desired, the cylinder is easily replaced with a new cylinder by simply depressing the latch bolt of the existing cylinder and withdrawing it from the handle.

Mfg # FOYPT1010 EZ # 003907



Vending Machine Lock

Pop out T handle with chrome finish. Threaded shaft operated handle. Inner cylinder not included.

Mfg # NLPT12 EZ # 078300



Showcase Locks

Mfg # FOMFWSG29000KD

EZ # 003825

Mfg # FOMFWSG29000KAD3012

EZ # 003826



Keying Kits

Mfg#	Description	EZ #
FORKK110	Gem Pin Kit	026360
FORKK130	Wafer Kit	026363



Trailer & Gate Lock

- 5000 series double bitted
- 6 tumbler • Key blank 750
- Solid die cast construction
- 90 degree key rotation
- Key retained in unlocked position

Mfg # FOTL37KD EZ # 065418

Mfg # FOTL37KA EZ # 065419



Key Blanks

FOK137	Tubular - steel	003815
FO752	6 disc/8000 series	003819
FO775	6 disc/9000 series	003908
FOS900	5 disc/29000 lock	003904
FO750	6 disc/5000 series	003818
FO757	6 disc/5000 series	003820





Furniture Locks

Disc Tumbler Locking Handles

Application – For RH or LH doors on metal lockers and cabinets. Choice of spindle lengths and mounting. Spindles accept both C8756 latch plate and C8757 tongue. Spindles can be cut to fit special requirements.

Operation – Key removable in both locked and unlocked positions. 90° counter clockwise direction of turn to open.

Keying – Disc tumbler locks using D8785 key blank.

Packaging – Supplied with two keys and mounting hardware.

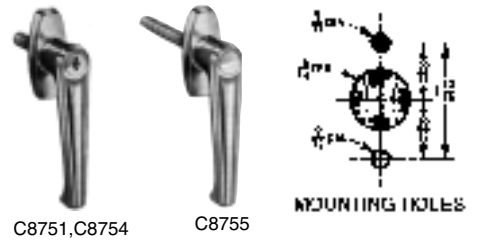

Mfg. #	Keying	Type of Mount	Spindle Length	EZ #
NLC8751 26D KA C415A	C415A	Rear	1"	041678
NLC8751 26D KD	KD	Rear	1"	011332
NLC8754 26D KA C420A	C420A	Rear	3"	041679
NLC8754 26D KD	KD	Rear	3"	011335
NLC8755 26D	-	Rear	3"	011336

Latch Plate & Tongue

3 point latch plate w/tongue
Used w/locking bars
Mfg # NLC8756 2C EZ # 027273

Single point latch tongue.
Mfg # NLC8757 2C EZ # 027274



Furniture Locks

Application – This lock is used primarily on furniture and other fine cabinetry. C8826 is surface mounted and requires hole for key entry.

Keying – Each lock furnished keyed alike.

Packaging – Supplied with one key.

Key hole escutcheon included.

Mfg. #	Installation Type	Bolt Travel	EZ #
NLC8826	Surface mount	21/64"	041681



Chest/Lid Locks

Application – Lid locks for cedar chest application and other lid locking requirements. C8414 is surface mounted and has a 7/8" cylinder length that requires a 9/16" dia. hole. C8384 requires 11/32" wide x depth of lock full mortise plus mortise for selvedge plus hole for key entry.

Operation – Key removable in both locked and unlocked positions. C8414 uses pushbutton to release lid when lock is used as a latch to keep lid closed, but not locked.

Packaging – Supplied with one key. Appropriate strikes and mounting screws supplied with locks with additional keyhole escutcheon furnished with C8384.

Mfg#	Installation Type	EZ #
NLC8384 3	Full mortise hookbolt 5/16" travel	027258
NLC8414 4G KA	Surface mount internal bolt	011300

Garage Door Mechanism-Locking Handle

Application – For mounting on sectional overhead doors. Assembled for RH mounting, mechanism installs at right side of door to lock into track. **Packaging** – Supplied with mounting screws. **Keying** – Available keyed different

Mfg # NLC8797 EZ # 069445



Key Blanks

Mfg. #	EZ #	Mfg. #	EZ #	Mfg. #	EZ #
<i>Pin Tumbler</i>		<i>5 Disc Tumbler</i>		<i>Freezer Keys</i>	
NLD4291	011344	NLD8785	011360	NLD8590	011352
NLD4292	011345	NLD8786	011361	NLD8591	011353
NLD4293	011346	NLD8776	073362	<i>Warded Barrel</i>	
NLD4295	011347	<i>HON Key Blank</i>		NLD8890	011372
<i>4 Disc Tumbler</i>		NLM5 0698 111 20001J	079401	<i>Paracentric Lever Tumbler</i>	
NLD8782	011357	NLM5 0690 111 20000J	079402	NLD8490	011350

Pin Tumbler Cylinder Cam Locks

Die Cast Construction

For drawer, RH or LH doors with lipped or overlay construction.

90° cam turn, key removable in both locked and unlocked positions.

Will key together with all other pin tumbler locks using D4291 key blank.

Two keys, spur washer for wood, mounting nut and two cams.



Mfg. #	Keying	Cyl. Length	Max. Thick.	EZ #
NLC8111 26D KA101	KA101	15/16"	5/8"	027230
NLC8102 26D KA101	KA101	1 1/16"	3/4"	027232

Pin Tumbler Cylinder Cam Lock

Brass Construction

For drawers, RH or LH doors. For flush type mounting.

90° cam turn, key removable in both locked/unlocked positions.

Will key together with all other pin tumbler locks using D4291 key blank.

Two keys, trim washer, spur washer for wood, mounting nut and two cams.



Mfg. #	Keying	Cyl. Length	Max. Thick.	EZ #
NLC8108 26D KA101	KA101	1 3/4"	1 3/8"	027229

Disc Tumbler Gang Lock

For locking drawers in desk pedestals and other multiple drawer applications

Key removable in both locked and unlocked positions.

Will key together with all other disc tumbler locks using D8785 key blank.



Mfg. #	Cyl. Length	EZ #
NLD8090 14A KD	15/16"	045970

Mounting Plate

For cylinder cam locks, screw mounted. Use where spur washer will not embed into hard surface.

Mfg. # NLC2016 2C EZ # 082703



Disc Tumbler Cams

Selection of cams that permit adaption of disc tumbler cylinder cam locks to meet various application needs.

Mfg. #	Description	Length	EZ #
NLC7004 2C	Straight Cam	2"	061692
NLC7005 2C	Straight Cam	3"	036410
NLC7008 2C	Straight Hook Cam	1 1/2"	061693



Disc Tumbler Cylinder Cam Locks

Application – For drawers, RH or LH doors with lipped/overlay or flush construction.

Operation – 90° cam turn, key removable in both locked and unlocked positions.

Keying – Will key together with all other disc tumbler locks using D8785 key blank.

Packaging – Two keys, trim washer, spur washer for wood, mounting nut and two cams.



Mfg. #	Cyl. Length	Max. Thick.	EZ #
NLC8051 14A KA C346A	7/16"	7/64"	027210
NLC8052 14A KA C420A	5/8"	15/64"	027212
NLC8052 14A KD	5/8"	15/64"	011235
NLC8054 14A KD	15/16"	5/8"	011241
NLC8054 14A KA C413A	15/16"	5/8"	041662
NLC8053 14A KA C346A	1 3/16"	7/8"	027217
NLC8053 14A KA C413A	1 3/16"	7/8"	041658
NLC8053 14A KD	1 3/16"	7/8"	027219
NLC8053 3 KA C346A	1 3/16"	7/8"	041655
NLC8053 3KD	1 3/16"	7/8"	041657
NLC8055 3KD	1 7/16"	1 1/8"	041663
NLC8055 3KA C413A	1 7/16"	1 1/8"	041665
NLC8055 14A KA C415A	1 7/16"	1 1/8"	041666
NLC8055 14A KA C346A	1 7/16"	1 1/8"	036413
NLC8060 14A KA C415A	1 3/4"	1 7/16"	041671
NLC8060 14A KD	1 3/4"	1 7/16"	011246
NLC8075 14A KA C420A	1 7/16"	1 1/8"	062791

Pin Tumbler Door And Drawer Locks

- Requires 5/16" dia. hole for cylinder.
- Key removable in both locked and unlocked positions.
- Will key together with all other pin tumbler locks using D4291 key blank.



C8179

Deadbolt - 3/4" Bolt Travel

Mfg. #	Cyl. Lgth.	EZ #
NLC8173 26D KD	7/8"	011294
NLC8173 26D KA101	7/8"	036416
NLC8179 26D KA107	1 3/8"	036426
NLC8179 26D KD	1 3/8"	036428



C8173

Application – 8133 & 8135 for drawers. 8137 for center drawers

Keying – Will key together with all other pin tumbler locks using D4291 key blank.

Mfg. #	Cyl. Lgth.	EZ #
--------	------------	------

1/4" Bolt Travel

NLC8133 26D KD	7/8"	011270
NLC8133 26D KA101	7/8"	036422
NLC8135 26D KA107	1 1/8"	041672



C8133

7/16" Bolt Travel

NLC8137 26D KA3	19/32"	078294
-----------------	--------	--------



C8137



Sliding Door Locks • Keying Kits

Disc Tumbler Door and Drawer Locks

- Surface mounted. Requires 7/8" dia. hole for cylinder.
- Key removable in both locked and unlocked positions.
- Will key together with all other locks using D8785 key blank.
- Supplied with two keys and mounting screws.

Deadbolt - 11/32" Bolt Travel

Mfg. #	Lgth.	EZ #
NLC8703 3 KA C346A	15/16"	041675
NLC8703 3 KD	15/16"	011305
NLC8703 14A KA C420A	15/16"	027266
NLC8704 3 KA C390A	15/16"	027268
NLC8704 3 KD	15/16"	011307
NLC8705 3 KD	1 3/16"	041676
NLC8803 3 KA C415A	15/16"	028098
NLC8803 3 KA C413A	15/16"	041680
NLC8803 3 KD	15/16"	028099
NLC8803 14A KA C413A	7/8"	081058
NLC8803 14A KA C415A	7/8"	028706
NLC8803 14A KD	7/8"	064166



C8703, C8705



C8704



C8803

Drawer Locks

Disc Tumbler

- For center drawers of metal desks; 1/4" max material thickness. Fits special piercing of drawer front and selvedge. Has reinforced insertable dead bolt.
- Key removable in both locked and unlocked positions.
- Will key together with locks using D8785 key blank
- Cylinder length - 19/32"; Bolt travel - 11/32"



C8701

Mfg. #	Keying	EZ #
NLC8701 14A KA C413A	C413A	041674
NLC8701 14A KD	KD	011303

Disc Tumbler File Cabinet Lock

Shaw Walker File Cabinet

Application - Used internally on filing cabinets to gang lock drawers

Operation - Key removable in locked position only

Keying - Keyed only to "Pundra" keyway D8776

Packaging - Supplied with two keys

Mfg # NLC8047 26KAP141 EZ # 068447



Pin Tumbler File Cabinet Lock

• Used internally on filing cabinets to gang lock drawers. Has spring bolt with 1/8" travel.

• Will key together with all other pin tumbler locks using D4291 key blank.

• Key removable in locked position only.

Mfg # NLC8150 26D KA101 EZ # 036429

Mfg # NLC8150 26D KD EZ # 011282



Sliding Door Locks

Pin Tumbler

Application - For wood sliding doors and requires a 7/8" dia. hole in front door for cylinder.

Operation - C8142: key removable in both locked and unlocked positions.

Keying - Will key together with all other pin tumbler locks using D4291 key blank.

Packaging - Supplied with two keys. C8142 furnished with strike and mounting screws.



C8142

Mfg. #	Keying	Cyl. Lgth.	Bolt Travel	EZ#
NLC8142 26D KA106	KA106	1 1/8"	7/16"	041673
NLC8142 26D KD	KD	1 1/8"	7/16"	011276

Disc Tumbler

Application - For wood sliding doors. Requires a 7/8" dia. hole for cylinder.

Operation - C8042 : push in cylinder, key turn engages bolt behind strike. C8043: pushing in cylinder locks doors.

Keying - Will key together with all other disc tumbler locks using D8785 key blank.

Packaging - Supplied with two keys, strike and mounting screws.



C8042



C8043

Mfg. #	Keying	EZ #
NLC8042 26D KA C413A	C413A	041653
NLC8042 26D KA C346A	C346A	011230
NLC8043 26D KA C413A	C413A	041654
NLC8043 26D KD	KD	028095

Keying Kits

Pin Tumbler Keying Kit

- 100 Pcs. ea. 0-9 tumblers
- 100 Pcs. ea. 1-4 drivers
- 250 Pcs. tumbler springs
- 100 Pcs. tumbler retainers
- 50 Pcs. ea. C3735 and C3738 plug retainers

Mfg # NLV70P1 EZ # 011381

Pin Tumbler Master Keying Kit

- 100 Pcs. ea 2-9 master drivers
- Mfg # NLV70P2 EZ # 011382

Disc Tumbler Keying Kit

- 100 Pcs. ea. 00, 22, 44 and 66 tumblers
 - 250 Pcs. tumbler springs
- Mfg # NLV71D3 EZ # 011383

Disc Tumbler Master Keying Kit

- 100 Pcs. ea. 02, 04, 06, 20, 24, 26, 40, 42, 46, 60, 62 and 64 tumblers
 - 250 Pcs. tumbler springs
- Mfg # NLV71D4 EZ # 011384



Pin Tumbler Mail Box Locks

Genuine Factory Replacement Locks

- For doors on architectural boxes serviced by United States Postal Service. • Key removable in locked position only.
- Supplied with two keys and a spring mounting clip where required. C8720 furnished with trim ring.

Mfg. #	Fin.	Turn	Replaces	EZ #	Mfg. #	Fin.	Turn	Replaces	EZ #
NLC8710	26	90° c/cw	Bommer Industries	011311	NLC8718	26	90° c/cw	Cutler Mail Chute	011319
NLC8711	26	90° c/cw	Bommer Industries	011312	NLC8719	26	90° c/cw	Miami-Carey	011320
NLC8712	26	90° c/cw	Bommer Industries	011313	NLC8720	26	90° cw	Dura Steel	011321
NLC8713	14A	90° c/cw	Auth Electric	011314	NLC8721	26	90° c/cw	Permabuilt – XL-201	011322
NLC8714	26	90° c/cw	American Device	011315	NLC8722	26	90° cw	Dura Steel – XL-202	011323
NLC8715	26	90° c/cw	Florence Mfg	011316	NLC8723	14A	90° c/cw	Jensen General	011324
NLC8716	26	90° cw	S. H. Couch	011317	NLC8724	26	90° c/cw	Bommer Industries	011325
NLC8717	26	90° c/cw	Nutone	011318					



Pin Tumbler “Multi-Cam” Mail Box Locks

Application—Interior architectural mail boxes. Nut or clip mounted.

Operation—90° c/cw cam turn. Key removable in locked position only.

Packaging—Supplied with selection of five cams, two keys, mounting nut/clip and cam screw.

Mfg # NLC8730 14A KD
EZ # 041677



Application—Exterior pedestal-mounted boxes. Clip mounted.

Operation—90° cw cam turn. Key removable in locked position.

Packaging—Supplied with selection of five cams, three keys, mounting clip and locking cam nut.

Mfg # NLC8735 14A KD
EZ # 011328

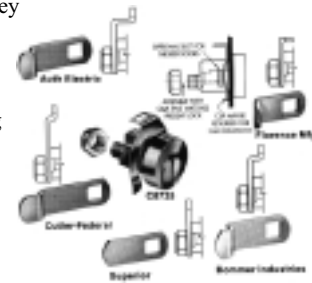

Pin Tumbler Cabinet Lock

Application – For metal cabinet doors. Reversible for RH or LH application. Latch plate is used for either in 2 or 3 point latching.

Operation – 90° turn to open.

Keying – Will key together with all other pin tumbler locks using D4291 key blank.

Mfg. #	Keying	Max Mat Thick.	EZ #
<i>Key removable in both locked and unlocked positions</i>			
NLC8154 26D KD	KD	1/8"	011284
<i>Key removable in locked position only</i>			
NLC8155 26D KA915	KA	1/8"	027251



Cabinet Locks

Bezels

Mfg. #	Finish	EZ #
NLC100BZ14A	Nickel	072867
NLC200BZ8	Old English	073346
NLC300BZ19	Black	073347
NLC400BZ20	Statuary Bronze	072868
NLC500BZ3	Brass	073270



Front & Side Gang Locks

For locking banks of drawers in desks, credenzas and other multiple drawer applications.

Front Gang Lock

Mfg # NLD100CB EZ # 073284

Side Gang Lock

Mfg # NLD150CB EZ # 073285

NLD100CB



NLD150CB

Door Locks

Surface mounted, setback of 1/2" is ideal for overlay doors

Mfg # NLC290CB EZ # 073280

Surface mounted, setback of 3/2" is ideal for inset doors or locking one door behind another

Mfg # NLC240CB EZ # 073282



NLC290CB



NLC240CB

Drawer Locks

Surface mounted, setback of 1/2" is ideal for overlay drawers

Mfg # NLC280CB EZ # 073281

Surface mounted, setback of 3/2" is ideal for inset drawers

Mfg # NLC230CB EZ # 073283



NLC280CB



NLC230CB

Double Door Lock

Surface mounted lock for locking two adjacent doors. Eliminates the need for a spring catch on the door opposite the lock.

Mfg # NLC250CB EZ # 073277

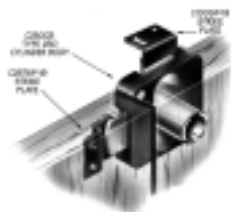

Push Lock

For locking sliding, bypass type doors. Requires 3/4" hole in front door for cylinder. Supplied with nickel plated finish cup.

Mfg # NLC175CB EZ # 073294



Lock Plugs

- Small diameter • High quality/long life
- Solid brass keys • Coded on face & keys
- Master-keyed standard • Removable lock plug

Mfg. #	Finish	EZ #
NLC100LP14A KD	Nickel	072869
NLC100LP14A KA101T	Nickel	073272
NLC200LP8 KD	Old English	073353
NLC200LP8KA101T	Old English	073997
NLC300LP19 KD	Black	073354
NLC300LP19KA101T	Black	073998
NLC400LP20 KD	Statuary Bronze	073351
NLC400LP20KA101T	Statuary Bronze	072858
NLC500LP3 KD	Polished Brass	073352
NLC500LP3KA101T	Polished Brass	073274



Rekeying Kit

Mfg # NLV72DTL

EZ # 084496



Cam Lock Kit

Universal lock for either doors or drawers. Two straight and two bent cams supplied.

Mfg # NLC165CB EZ # 072873



Thick Panel Lock

Universal lock for either doors or drawer that can accommodate panel thickness from 7/8" to 1 3/8" thick

Mfg # NLC170CB EZ # 072872



Change Tool

Required to remove lock plugs in cylinder bodies

Mfg # NLD500KY EZ # 072875



2 Drawer Side Gang Lock

Two drawer gang lock for locking two pedestal drawers with a single lock. Lock mounts on side of cabinet. Supplied with two drawer clips.

Mfg # NLD270CB EZ # 073276



Strikes

Mfg. #	EZ #
NLC100SP19	073335
NLC101SP19	073336
NLC185SP19	073337



CK4200 Series Heavy Duty – Grade 1

- Patented “lock-on” rose liners and thimble increase security and prevent lock from loosening
- 1 3/4” knob shank minimizes wear • 5/8” latch and concealed knob catch enhance strength and security

Mfg#	Style	Fin.	Function	Kwy	BS”	EZ #
CRCK4251GRC626LC	GRC	626	Entry	L/C	2 3/4”	002859
CRCK4255GRC626LC	GRC	626	Classroom	L/C	2 3/4”	002864
CRCK4257GRC626LC	GRC	626	Storeroom	L/C	2 3/4”	002868



CK4400 Series Standard Duty – Grade 2

- Stainless steel latchbolt for long life • Adjustable latchbolt accomodates flat and beveled doors
- Inside rose liner throughbolted to lock chassis to ensure proper alignment and smooth operation

Mfg#	Style	Fin.	Function	Kwy	EZ #
CRCK4440GWC613DP	GWC	613	Patio/Privacy	N/A	027734
CRCK4451BWC630LC	BWC	630	Entry	L/C	002871
CRCK4451GWC629LC	GWC	629	Entry	L/C	084156
CRCK4451GWC630LC	GWC	630	Entry	L/C	002874
CRCK4457GWC630LC	GWC	630	Storeroom	L/C	002881

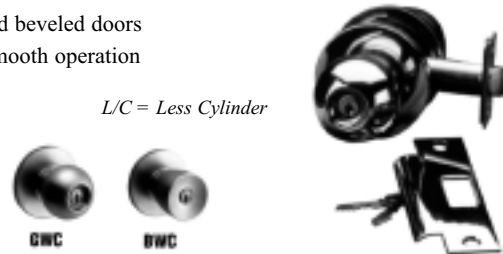

L/C = Less Cylinder

CL3900 Series Standard Duty – Grade 2

- Patented Lever Release design for vandal resistance., Solid cast levers. • Anti-rotational throughbolts prevent chassis rotation.
- Slide in locking plate allows for easy in-field door width adjustment.

Mfg#	Style	Fin.	Function	Kwy	EZ #
CRCL3910NZZD625	NZD	625	Passage	N/A	084154
CRCL3910NZZD626	NZD	626	Passage	N/A	068187
CRCL3920NZZD626	NZD	626	Privacy	N/A	068189
CRCL3951NZZD613LC	NZD	613	Entrance	L/C	068184
CRCL3951NZZD625LC	NZD	625	Entrance	L/C	084155
CRCL3951NZZD626LC	NZD	626	Entrance	L/C	068183
CRCL3957NZZD613LC	NZD	613	Storeroom	L/C	068186
CRCL3957NZZD626LC	NZD	626	Storeroom	L/C	068185



L/C = Less Cylinder

CL3300 Series Heavy Duty – Grade 1

- Patented Lever Release design for vandal resistance. Solid cast levers. • Anti-rotational throughbolts

Mfg#	Style	Fin.	Function	Kwy	EZ #
CRCL3351NZZD626LC	NZD	626	Entrance	L/C	069112
CRCL3310NZZD626	NZD	626	Passage	N/A	069110
CRCL3320NZZD626	NZD	626	Privacy	N/A	069111



Cylinders

Mfg#	EZ #	Mfg#	EZ #	Mfg#	EZ #
<i>For CL3300 Series</i>		<i>For CL3900 Series</i>		<i>I/C Core</i>	
CR2000 033 626 6L4	069115	CR2000 039 626 6L4KR	068198	CR8000 6D2R626	062686
CR2000 033 626D1	069117	CR2000 039 626 6981KR	068195	CR8000 6D1R626 KA211521	072271
CR2000 033 59A1 626	069118	<i>For CL4400 Series</i>		CR8000 6D1R626OBIT	083606
CR2000 033 59A2 626	082579	CR2000 044 619 6D2KR	068211	CR8000 59A1 626 KA211521	072270
<i>For CL3900 Series</i>		CR2000 044 619 6L4KR	068206	CR8000 59A1 626OBIT	083608
CR2000 039 606 6D1KR	068191	CR2000 044 619D1	003039	CR8000 59A2 626OBIT	083609
CR2000 039 606 6D2KR	068193	CR2000 044 619 981	003040	CR8000 60 626 KA	062687
CR2000 039 606 6L4KR	068197	CR2000 044 626 59A1 0 BIT	080322	CR8000 60 626OBIT	083607
CR2000 039 606 6981KR	068196	CR2000 052 626 6D1KR	068207		
CR2000 039 626 59A1 0 BIT	084157	CR2000 052 626 6D2KR	068210		
CR2000 039 626 6D1KR	068192	CR2000 052 626 6L4KR	068209		
CR2000 039 626 6D2KR	068194	CR2000 052 626 6981KR	068208		



Mortise Locksets • Rim Exit Devices Deadlocks • Key Blanks • Cylinders



Heavy Duty Mortise Locksets

- Meets federal specifications 86 and 87
- Through bolted trim assures smooth operation
- Meets ANSI Grades 1, 2 and 2L.
- Long-throw (3/4") antifricition latch bolt
- Heavy gauge steel case 1" throw dead bolt



2010 Passage Lock

Latch bolt by grip either side. Both knobs always free.

2024 Entrance or Storeroom Lock

Latch bolt by grip either side. Deadbolt by key outside or by turnpiece inside.

2048 Entrance or Apartment Lock

Latch bolt by key outside and grip either side unless outside knob is locked by stop. Deadbolt by key outside or by turnpiece inside. Inside grip always free.

2051 Entrance or Office Lock

Latch bolt by key outside or by grip either side unless outside knob is locked by stop. Auxiliary latch deadlocks latchbolt. Inside grip always free.

2055 Classroom Lock

Latch bolt by grip either side unless outside knob is locked by key outside. Auxiliary latch deadlocks latchbolt. Inside grip always free.

2057 Storeroom or Closet Lock

Latch bolt by grip inside or by key outside. Auxiliary latch deadlocks latchbolt. Outside grip always rigid.

2060 Privacy Lock

Latch bolt by grip either side, except when outside is locked by thumbturn inside.

Mfg. #	Design	Function	EZ #
CRML2010LWA626	LWA	Passage	083583
CRML2024GWM626D1	GWM	Ent/Strm	041903
CRML2048GWM626D1	GWM	Ent/Apt	041904
CRML2051GWM626LC	GWM	Ent/Off	002968
CRML2051LWA626LC	LWA	Ent/Off	083585
CRML2055NSA626LC	NSA	Classroom	080337
CRML2057LWA626LC	LWA	Storeroom	083586
CRML2060LWA626	LWA	Privacy	083584

LC = Less Cylinder

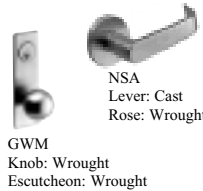

Door Closers (adjustable 1-6)

- DC2000 for high use, high abuse environment
- DC3000 for mid priced, cost effective use

Mfg # CRDC2210 689 EZ # 069368

Mfg # CRDC3210 689 M54 EZ # 062779



ED8000 Pushbar Exit Device

- Dogging feature is standard on all devices
- All trim will cover 161 cylindrical lock prep
- UL Listed • Reversible
- Stocked Exit Only



Mfg#	Size	Fin.	EZ #
CRED8200 689W036	36"	Silver Alum.	002910
CRED8200 689W042	42"	Silver Alum.	002911
CRED8200 690W036	36"	Dark Bronze	077400
CRED8200 691W036	36"	Light Bronze	002908

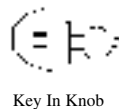

Outside Trim For ED8000 Series

Mfg#	Desc.	Kwy	EZ #
CRP857 689LC	Key pull	Less cyl	027371
CRP857 691 LC	Key pull	Less cyl	041893
CR416F35 26D	Dbl door strike	N/A	041892
CRN555 626 6D1	Lever	6D1	068205
CRG1055 626D1	Key in knob	6D1	027369

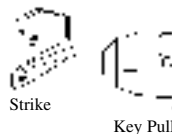

Original Key Blanks

Mfg#	Description	EZ #
CRX1 77 5	5 pin	035322
CR5D1R	5 pin	041907
CR5981R	5 pin	041917
CR5982R	5 pin	041918
CR60 5 10	5 pin	002780
CR852 5 10	5 pin	003113
CRX1 67 6	6 pin	040264
CRX1 77 6	6 pin	035323
CRZ1 59A1 6	6 pin	040265
CRZ1 59B1 6	6 pin	040266
CR6D1R	6 pin	035321
CR6D12R	6 pin	041914
CR6D2R	6 pin	041908
CR6D3R	6 pin	041910
CR6D4R	6 pin	027389
CR59A2 6 10	6 pin	002773
CR60 6 10	6 pin	002781
CR6981R	6 pin	041920
CRL1 6PIN10	6 pin	070892
CRL3 6PIN10	6 pin	070893
CRL4 6PIN10	6 pin	029705
CRL41 6PIN10	6 pin	070894
CR7D1R	7 pin	041915

Control Key

CRIC CONTROL KEY C060	063892
CR59A1 CONTROL KEY	072272
CR6D1R CONTROL KEY	072273

Deadlatches

Mfg#	B.S.	For Series	EZ #
CR574F29 630	2 3/8"	4400	003090
CR574F55 630	2 3/4"	4400	003092
CR486F89 626	2 3/4"	4200	003085
CR679F06 626	2 3/4"	3900	069848
CR679F13 613	2 3/8"	3900	068199
CR679F13 626	2 3/8"	3900	068200

Deadlocks

Mfg # CRDL2112 626 6D1
EZ # 041898 Double Cylinder



Mfg # CRDL2113 626 6D1
EZ # 041897 Single Cylinder



Mortise Deadlock

Mfg # CRDL4012 626 6D1
EZ # 041899 Double Cylinder

Cylinders

Mfg# EZ #

Mortise Cylinders (A02 straight cam)

CR1000 118 A02 626 5981	041891
CR1000 118A02 6D1R626	068203
CR1000 118A02 6L4 626	068204



Rim Cylinders

CR3000 200 626D1	027380
CR3000 200 626 981	003004





ECL-230D

A versatile combination deadbolt exit alarm, especially designed to prevent unauthorized use of emergency exits. It remains securely locked from the outside and inside, yet is always ready to be opened during emergencies. When mounted on a single door, withdrawal of the bolt directly unlocks the door. Authorized use by means of a key in the control cylinder, inside or outside, allows you to unlock the door without sounding the alarm. Locking always arms the alarm system. The warning sign on the paddle bar alone (in braille) is enough to deter most unauthorized use.

- Handing is field reversible • Five year warranty
- U.L. Listed under "Exit Locks" No. 414A • Rim cylinders not included
- Lock Case: 10 3/8" H x 5 3/4" W x 3 3/4" D
- Push Plate & Bar: 3 1/2" H x 12 7/8" W

Mfg # DT230D EZ # 003270



EA-500 & EA2500S Exit Alarms

- Adapts easily to narrow stile doors • Magnetic switch trigger
- 95-decibel, directional alarm • Separate screw-on cam lock on cover
- Closed-loop circuitry for all sensors means alarm will sound any time the circuit is broken
- Adjustable time delay (5-30 seconds) • Low battery alert; uses standard 9V alkaline battery
- LED blinks once a minute to indicate power-on, and remains on during authorized passage
- Uses standard 5 or 6 pin rim cylinder. Alarm can only be deactivated by authorized key holder
- Rim cylinder not included • Outside key control capability

Mfg # DTEA500 Surface Mount Battery Alarm EZ # 003275

Mfg # DTEA2500S Surface Mount AC Alarm with Call Bell & Infinite Shunting capability EZ # 065948



V40EB Relatching Exit Control

Offers unsurpassed economy and electronic reliability. Ideally suited for low traffic and remote locations where AC power is not available. Micro processor controls the unit for dependable, instant response. The tamper proof cover and heavy-duty lock and bolt mechanism resist the most aggressive efforts to defeat them. Unit requires an authorized key for resetting and carries a one-year warranty

Mfg # DTV40EB 36" EZ # 066971



Accessories and Parts

Mfg #	Desc.	EZ #
DTECL2111K	Battery Conversion Kit	065219
DTECL1576 15	Cam Bridge for 230	003266
DTECL435K	Sgl Door Adj Surface Keeper	003273
DTECL475K	Mount Plate for narrow stiles	003274
DTPP5572	Cover Lock	003268
DTECL271	Battery Wire Assembly	040301
DT90KR96	96" Key Removable Mullion	073105



DTECL2111K



DTPP5572



DTECL 435K

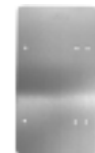

DTECL 475K

Push & Pull Plates

Don-Jo Not Stocked At IDN-Acme

Mfg#	Desc	Size	EZ #
DJPL13515 605	Display packaged pull plate	3 1/2" x 15"	068285
DJPL13515 630	Display packaged pull plate	3 1/2" x 15"	068286
DJPS13515 605	Display packaged push plate	3 1/2" x 15"	068283
DJPS13515 630	Display packaged push plate	3 1/2" x 15"	068284
DJ71 10B	Push plate	4" x 16"	044393
DJ71 28	Push plate	4" x 16"	029783
DJ71 3	Push plate	4" x 16"	029782
DJ7110 10B	Pull plate	4" x 16"	044394
DJ7110 28	Pull plate	4" x 16"	029778
DJ7110 3	Pull plate	4" x 16"	029776

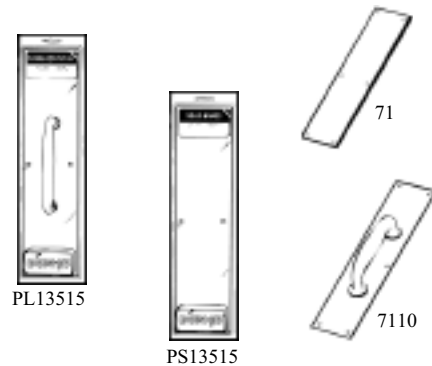

Strikes

Mfg#	Desc	Size	EZ #
DJST161 605	Standard ANSI	4 7/8" x 1 1/4"	075190
DJST161 613	Standard ANSI	4 7/8" x 1 1/4"	075189
DJST161 626	Standard ANSI	4 7/8" x 1 1/4"	075191
DJTS100BP	Thimble strike (brass)	1" diameter	074978
DJTS100CP	Thimble strike (chrome)	1" diameter	066161
DJ2SS	Key-in-knob security strike	4 7/8" x 1 1/4"	003231

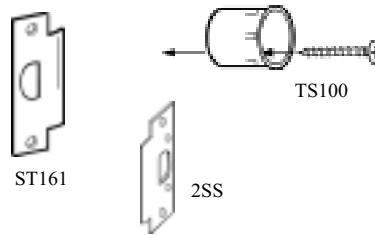

Stops, Holders & Bumpers

Mfg#	Desc	EZ #
DJ1406 605	Convex wall bumper	074779
DJ1406 613	Convex wall bumper	075161
DJ1406 626	Convex wall bumper	074367
DJ1407 605	Concave wall bumper	074780
DJ1407 613	Concave wall bumper	075160
DJ1407 626	Concave wall bumper	074368
DJ1440 605	Low style floor stop	074781
DJ1440 613	Low style floor stop	075162
DJ1440 626	Low style floor stop	074369
DJ1455 605	4" door holder	075163
DJ1455 626	4" door holder	075164
DJ1468	Replacement tip for 1455	074374
DJ1500 605	Hinge stop	075167
DJ1506 605	3 1/4" rigid base stop	075168
DJ1506 626	3 1/4" rigid base stop	075169
DJ1508 605	3" spring stop	075170
DJ1608	Metal door silencer	075165
DJ1609	Wood door silencer	075166

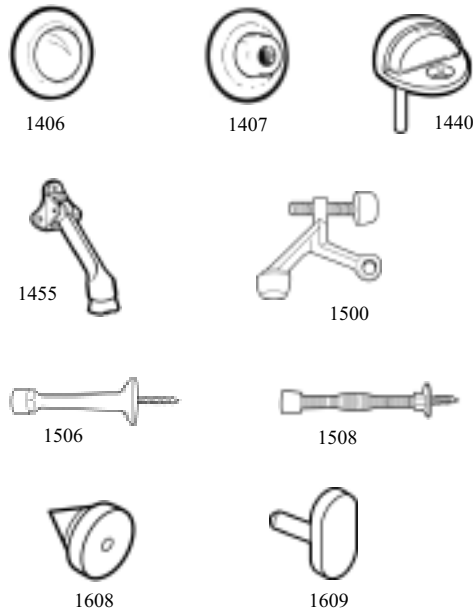

Roller Latch T-Strike

Mfg # DJ1702 605	EZ # 075171
Mfg # DJ1702 613	EZ # 075172
Mfg # DJ1702 626	EZ # 075173



Size:
3 3/8" x 1"

Strike:
1 3/4" x 2 3/4"

Kick Plate

Size: 8" x 34"
Mfg # DJ90 605 EZ # 075192
Mfg # DJ90 628 EZ # 075193



Latch Protectors

Don-Jo Not Stocked At IDN-Acme

Mfg#	Desc	Size	EZ #
DJAL211DU	Outswing alum. ent. doors	3 1/2" x 12"	026248
DJBLP207DU	Key-in-lever locks with up to 3 1/2" escutcheon	3 1/4" x 7"	075176
DJBLP207SL	Key-in-lever locks with up to 3 1/2" escutcheon	3 1/4" x 7"	075180
DJLP207DU	Key-in-knob locks on outswinging doors	2 3/4" x 7"	003188
DJLP211DU	Outswinging doors, completely covers strike plate	3" x 11"	003193
DJLP312DU	Adams Rite lock for outswinging doors	2 5/8" x 12"	003200
DJLP312SL	Adams Rite lock for outswinging doors	2 5/8" x 12"	003201
DJPLP211 626	Pin latch protectors for outswinging doors	3" x 11"	075182
DJPLP211BP	Pin latch protectors for outswinging doors	3" x 11"	029480
DJPLP211DU	Pin latch protectors for outswinging doors	3" x 11"	065946

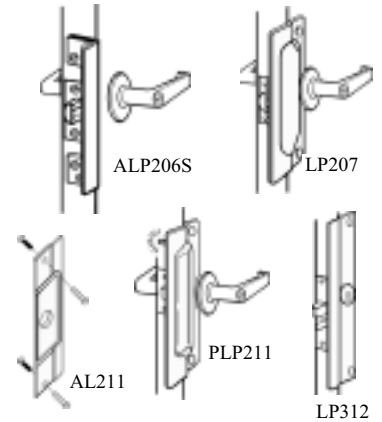

AR-335 Filler Plate

Allows for use of grade 1 key-in-levers on 1 3/8" door

- Mfg # DJAR335 630 EZ # 075185
- Mfg # DJAR335 605 EZ # 050060
- Mfg # DJAR335 613 EZ # 075187



BF-161 Filler Plate

Cover up to 2 1/8" hole

- Mfg # DJBF161BP EZ # 003147
- Mfg # DJBF161PC EZ # 003148
- Mfg # DJBF161SL EZ # 003149



BF-178 Filler Plate

Cover up to 1 1/2" hole

- Mfg # DJBF178BP EZ # 026252
- Mfg # DJBF178PC EZ # 003151
- Mfg # DJBF178SL EZ # 003152



PDF-161 Filler Plate

Cover up to 2 1/8" hole under rim panic device.

- Mfg # DJPDF161PC EZ # 027840



CV-86 Door Filler Plate

Converts 86 cut out to 161

- Mfg # DJCV86PC EZ # 075179



EF160/161 Door Filler Plate

Mfg # DJEF160BP EZ # 026254

- Mfg # DJEF160PC EZ # 075183
- Mfg # DJEF161PC EZ # 075184



EF-86 Door Filler Plate

Mfg # DJEF86PC EZ # 075181

BP = Brass Plated PC = Prime Coated
SL = Silver Coated DU = Duro Coated



BTS-160 Frame Filler Plate

T-strike with 160 cut out

- Mfg # DJBTS160PC EZ # 003154



FS260PC Frame Filler Plate

ANSI strike cut out

- Mfg # DJFS260PC EZ # 003176



Pocket Door Locks

2 1/2" x 2 3/4", field reversible, adjustable for various door thickness

Mfg	EZ #
DJPDL100 605	074979
DJPDL100 613	075174
DJPDL100 626	074591
DJPDL101 605	074980
DJPDL101 613	075175
DJPDL101 626	074590

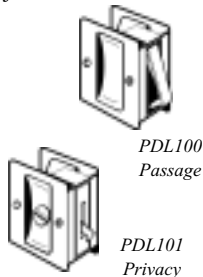

Door Viewer

9/16 installation hole, 180° view

- Mfg # DJULDV180 605 EZ # 075177
- Mfg # DJULDV180 626 EZ # 075178



Elbow Catch

- Mfg # DJ1590 605 EZ # 074791



Scar Plates

Converts 2 3/8" to 2 3/4" backset

- Mfg # DJSP135 605 EZ # 068290
- Mfg # DJSP135 630 EZ # 068291



Decals

- Mfg # DJDD1 EZ # 075186
- Color: Black on clear Size: 1 1/2" x 24"

- Mfg # DJDD3 EZ # 075188
- Color: Black on clear Size: 1 1/2" x 24"

THIS DOOR TO REMAIN UNLOCKED DURING BUSINESS HOURS

DD1

THESE DOORS TO REMAIN UNLOCKED DURING BUSINESS HOURS

DD3



Door Closers

8000 Series Exit Devices

- Deadlocking latchbolts minimize forced entry while offering a low cost solution to life safety requirements.
- U.L. Listed • Size "B" Doors 28" to 36" Wide
- 1 3/4" to 2 1/4" thick door • Non Handed

Mfg#	Desc	EZ #
DM8300B689	Rim Device	083644
DMF8300B689	Fire Rated Rim Device	083645
DM8400B689	Vertical Device	083646
DMF8400B689	Fire Rated Vert. Device	083647
DMR08 689	Exit Trim	083648

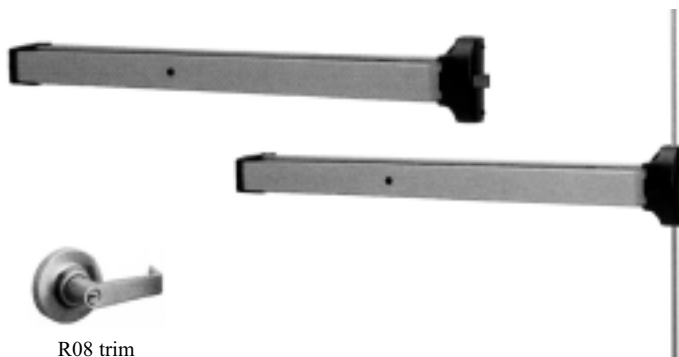

R08 trim

9000 Series Exit Devices

- Heavy duty devices provide superior durability for high impact applications such as schools, universities or commercial buildings.
- U.L. Listed • Size "B" Doors 28" to 36" Wide • 1 3/4" to 2 1/4" thick door • Non Handed

Mfg#	Desc	EZ #
DM9300B630	Rim Device	074302
DMF9300B630	Fire Rated Rim Device	074303
DM9300B613	Rim Device	084158
DM9301 613	Rim Device Only	084495
DMF9300B613	Fire Rated Rim Device	084159
DMYR03R613	Storeroom W/Bolt Trim	084162
DMYR03R630	Storeroom W/Bolt Trim	084160
DMYR08 613	Classroom Trim	084163
DMYR08 630	Classroom Trim	074305
DMYR09 613	Storeroom W/Latch Trim	084164
DMYR09C613	Storeroom W/Clutch Lever	094164
DMYR09 630	Storeroom W/Latch Trim	084161

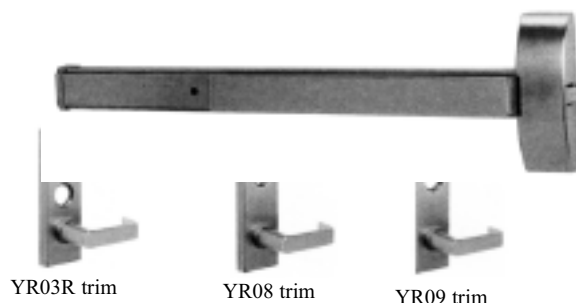

YR03R trim

YR08 trim

YR09 trim

8900 Series Heavy Duty Closer

- For interior and exterior barrier free requirement (adjustable size 1-6)
- U.L. Listed • ANSI A156.4 Grade 1 • 24 year warranty
- Full range spring power adjustment and backcheck, along with a narrow projection full cover and flat form style arm.

Mfg # DM8916AF89P689 EZ # 080373 AF89P - Parallel flat form arm, complete



7400 Series Surface Applied Closer

- 7414: Adjustable size 1-4", meets 5 lb barrier-free application
- U.L. Listed • ANSI A156.4 Grade 1 • 25 year warranty
- Adjustable backcheck standard. Provides cushioning when the door is abusively opened.

Mfg # DM7414 689ARP EZ # 085240

Mfg # DM7414 695ARP EZ # 085241

ARP - Round form non-hold open (parallel arm)





Grade 1 Leversets

ED800 Door Control

Using the world-renowned TS83 closer and a sophisticated, microprocessor-controlled electro-mechanical unit, DORMA has created an entirely new breed of intelligent door closers. The ED 800 continuously monitors door position, resistance, opening and closing needs and other variables. It will detect even the slightest deviation from the norm and respond instantly.

- Meets ADA NFPA guidelines and ANSI A156.19
- Requires only one person to install
- Non-handed
- Field adjustable from 5 lbs. (interior doors) to 11 lbs. (exterior doors) closing force
- Suitable for retrofit or new installations
- Stops and balances the door immediately if it senses an obstacle or unusual user response
- Senses the user's needs and will initiate a power opening or reduce the required opening force
- Reliably controls doors from 36"/100 lbs to 48"/200 lbs
- Interfaces easily with electric strikes, exit devices with electric latch retraction and other access control system components
- In standard operation, the unit provides all the benefits of an ANSI/BHMA Grade 1 door closer
- As a low-energy, power open operator, it opens the door but can be stopped with a force of 15 lbs. or less
- As a power assist unit, it allows the door to open by lightly pushing on it with a force adjustable from approximately 1.5 lbs. to 5.0 lbs.

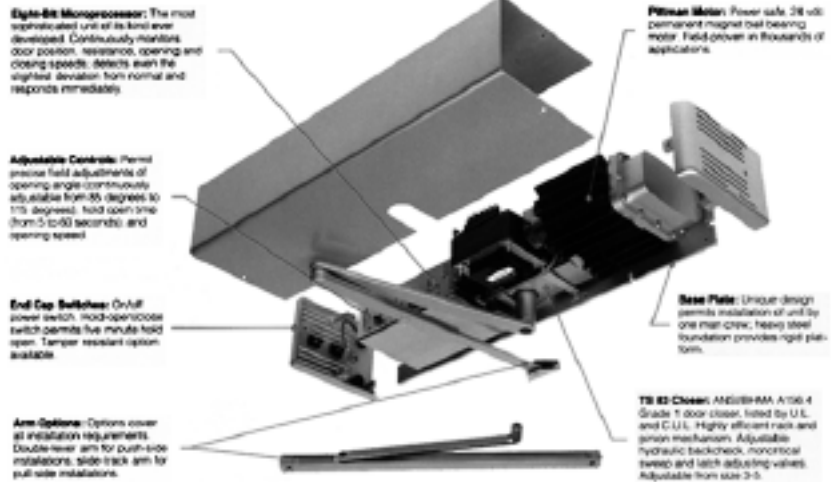

Mfg#	Color	EZ #
DMED800J AL	Aluminum	031178
DMED800J DURO	Duranodic Bronze	065875

Actuators

Mfg#	Desc.	EZ #
DM800RFR12	Radio freq. receiver	065881
DM800WS RFT1	Wireless wall switch	065880

800 RFR12: Powered from the 12VDC accessory output of the ED800

800 WS RFT1: Does not require hard wiring



CL800 Series Heavy Duty – Grade 1

- 3 7/16" diameter Rose
- 2 3/4" backset latch bolt with 1/2" throw
- 4 7/8" ANSI (ASA) curved lip strike
- 1 3/4" thick door
- U.L. listed, three hour fire rated
- ANSI A156.2 Series Grade 1

Mfg#	Function	EZ #
DMCL810LR C 626	Passage	083638
DMCL840LR C 626	Privacy	083637
DMCL853LR C 626	Entry	083636
DMCL870LR C 626	Classroom	083635
DMCL880LR C 626	Storeroom	083634
DMCL810LC C 626	Passage	083642
DMCL840LC C 626	Privacy	083643
DMCL853LC C 626	Entry	083641
DMCL870LC C 626	Classroom	083640
DMCL880LC C 626	Storeroom	083639



SC Surface Closer Series

Designed to meet the most common installation and application requirements in the commercial marketplace and in some cases, provide an identical Norton (1600/9300) & Yale footprint which makes renovation and retrofit work very simple. The SC Series features:

- Two separate hydraulic valves control the closing motion of the door.
- Closing force of closers can be increased by 15% using the power adjustment feature of the regular arm shoe.
- The operating swing of the door is controlled with a separate adjustable backcheck function.

SC60 Series

- SC60 closers are suitable for interior doors from 30" to 60" wide and exterior doors up to 42" wide. Certified to meet the requirements of ANSI Standard A156.4, Grade 1. Adjustable sizes 2 - 6.
- SC61 closers are suitable for interior doors up to 48" wide and can be adjusted to meet the ADA accessibility requirements. Adjustable sizes 1 - 4.
- All closers furnished with TBWMS fastener pack.

Mfg#	Description	EZ #
DRSC60AL	Aluminum closer	075194
DRSC60DKB	Dark bronze closer	075195
DRSC61AL	Aluminum closer	075196
DRSC61DKB	Dark bronze closer	075197
DRSC61DSHO AL	Aluminum closer with hold open	075198
DRDBA4357	Drop plate	083113

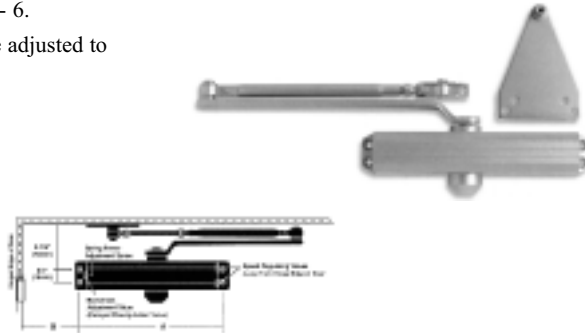

SC80 Series

- SC81 closers are suitable for interior doors up to 48" wide and can be adjusted to meet the ADA accessibility requirements.
- All closers furnished with TBWMS fastener pack & full cover

Mfg#	Description	EZ #
DRSC81FC AL	Full cover alum	075199
DRSC81FC DKB	Full cover dk bronze	075200
DRSC81DEL FC AL	Delay action / alum	075201
DRSC81DSHO FC AL	Hold open / alum	075202

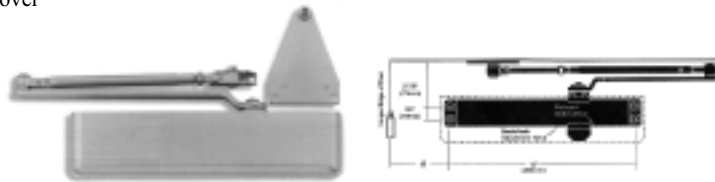

SC90 Series

- SC91 closers are suitable for lightweight interior doors and are preset. Certified to meet the requirements of ANSI Standard A156.4, Grade 3. Size 1.
- SC94 closers are suitable for interior doors from 36" to 48" wide and exterior doors to 36" wide. Size 4.
- All closers furnished with TBWMS fastener pack & back check.

Mfg#	Description	EZ #
DRSC91AL	Aluminum closer	075204
DRSC91DKB	Dark bronze closer	075203
DRSC94AL	Aluminum closer	075205
DRSC94DKB	Dark bronze closer	075206



1990 Series Concealed Vertical Rod

This ANSI Grade 1 device features hardened steel latches and is compatible with stiles as narrow as 1 3/4". The 1990 device is equipped with hardened steel latches and an adjustable strike to ensure safety, security and quiet operation.

- Concealed mounting screws • Exterior cylinder dogging • Field adjustable width
- U.L. Listed 305 • Available in a full range of painted and architectural finishes

Mfg # DR1990 26D EZ # 072931 Mfg # DR1990 313 EZ # 072930





Hide-A-Key

The original Hide-A-Key features the extra powerful, double size magnet not found on other brands. Attractive 11 1/4"x14 1/8" metal display stand comes with 12 Hide-A-Keys magnetically attached.

Mfg # ESHAK1 EZ # 026269



Hide-A-Key

Individual Hide-A-Key packed in its own small white box. Packed 24 per carton

Mfg # ESHAK3 EZ # 040318



Secur-A-Tach®

Made of flexible, nylon-type plastic that makes standard metal give-a-way key rings obsolete. Packed 1000 per box.

Mfg # ESPGA1000 EZ # 026271



Identa-Key Refills

Made of rubber-like vinyl, Identa-Keys will stretch and conform to fit snugly over virtually all key head sizes. Available in 5 colors, they provide a permanent, innovative method for customers to distinguish one key from another.

Mfg # ESIDK BLUE EZ # 040313

Mfg # ESIDK GREEN EZ # 040314

Mfg # ESIDK ORANGE EZ # 040315

Mfg # ESIDK RED EZ # 040316

Mfg # ESIDK YELLOW EZ # 040317



25 per bag

Multi-Tool

Great for pulling small springs, removing tru-arc rings, caps from cylinders, depressing pins, and other uses.

Mfg # ESCJ34 EZ # 003611



Lubricants

Graphite Lubricant

Guards against sticking, 6.5 gm puffer tube 12 tubes per pack

Mfg # ESL300 EZ # 028714

White Lubricant

Clean, greaseless, 1/8 oz. puffer tube 12 tubes per pack

Mfg # ESW51 EZ # 040337



Spring Wire Assortment

Includes 15 pieces each of the 7 most popular thicknesses of spring wire. All pieces are 12" in length.

Mfg # ESSWA100 EZ # 026270



Flat Spring Steel Assortment

Includes the 5 most popular sizes of spring steel, cut in 6" lengths.

Mfg # ESFSA50 EZ # 003628



Amarlite Lock Replacement

Exact replacement for the original Amarlite telescopic bolt lock. Locks supplied less cylinders. Cylinder holes are threaded for original Amarlite cylinder & other standard size mortise cylinders.

Mfg # ESAL77 EZ # 003607



Chesler Cylinder

Exact replacement for the Hurd No.96-158 lock cylinder. Used as a replacement in some Bargman Mobile Home and Recreational Vehicle locks. Features a five pin tumbler cylinder.

Mfg # ESCT1 EZ # 003619



Bulk Key Blanks

Mfg #	Desc.	EZ #
ESKW1PL	Kwikset	069982
ESY12PL	Yale	069983
ESY11PL	Yale	069984
ESHL1PL	Hudson	069985
ESWK2PL	Weslock	069986
ESM1PL	Master	069987
ESIN3PL	Ilco	069988
ESDE6	Dexter	069989
ESSC1PL	Schlage	069990
ESY1PL	Yale	069991
ESWR3PL	Weiser	069992
ESWR5PL	Weiser	069993
ESAR1PL	Arrow	069994



Original Key Blanks

Mail Box Lock - Key Blank (Ilco - 1503)

Mfg # ESES9 EZ # 003624

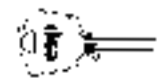

Sesamee Decoder

This tool was designed to decode the exact combination of a Sesamee padlock without drilling or damaging the padlock in any way!

Mfg # ESSD7 EZ # 040324





Pick Gun

This tool was specifically designed to span all the pins at once. Included with the tool are three types of stainless steel needles that fit most keyways and a stainless steel tension wrench.

Mfg # ESEZ1 EZ # 040309



Pin and Plug Deburring Tool

Here's a double-duty tool no professional Locksmith should be without. One end allows you to deburr the pin holes in the plug. The other end allows you to deburr pins you've filed.

Mfg # ESDB1008 EZ # 003621



Door Pins

By installing door pins, illegal entry by removing the door hinges is eliminated. Made of solid steel, AC-22 door pins are packed in a blister pack, 2 per card, mounting screws included.

Mfg # ESAC22 EZ # 040331



Nylon Key Deburring Brush

Strong enough to remove the toughest of burrs, the 25NB will not wear or distort the key cut depth. 3" dia., 1/2" dia. hole.

Mfg # ES25NB EZ # 040332



Installation Template Plates

For both tubular and mortise locksets. Whether on an old or new door, the ESP installation templates work every time!

Mfg # ESINT01 (tubular) EZ # 040310

Mfg # ESINT02 (mortise) EZ # 040312



Pinning Tweezers

Pinning tweezers featuring special, precision made grasping tips to make pin selection and rekeying faster and more efficient.

Mfg # ESPTW300 EZ # 040339



Cam Lock Rekeying Kit

Here's a no frills kit that gives you exactly what you need to rekey cam Locks - namely, WAFER TUMBLERS and SPRINGS! The CRK-30 features a portable, spill proof, durable vinyl case that fits snugly in your shirt pocket.

Mfg # ESCRK30 EZ # 040336



Ames Door & Lock Support

Both flexible and adjustable thus assuring use for any locks requiring 2 1/8", 1 5/8" or 1 1/2" cross bores

Mfg # AE1346 EZ # 000389



Mail Box Lock

Mail box lock with 5 removable cams. Meets U.S. Postal Service specifications.

Mfg # ESPT656UN5 EZ # 040344



Cam Locks

Mfg	Cyl. Length	EZ #
ES437KA	7/16"	040340
ES875KA	7/8"	040351
ES875KD	7/8"	040352
ES1125KA	1 1/8"	040354
ES1125KD	1 1/8"	040353
ES1375KA	1 3/8"	040355
ES1375KD	1 3/8"	040356

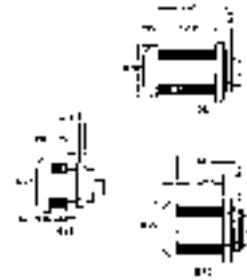

Automotive Replacement Face Caps

These stainless-steel chrome caps are exact replacements for original caps used on various door and trunk lock cylinders.

Mfg # ESST1 EZ # 040311



Sliding Door Ratchet Lock

Mfg # ES7RL KA202 EZ # 040322

Mfg # ES7RLKD EZ # 040323

Mfg # ES8RL KA202 EZ # 040325

Mfg # ES8RLKD EZ # 040326

Mfg # ES15RL KA202 EZ # 040328

Mfg # ES15RLKD EZ # 040330

7 = glass 8 = wood

15 = both glass & wood locking bar



Wood Desk Locks

Mfg # ES750WDL KA202 EZ # 040346

Mfg # ES750WDLKD EZ # 040347

Mfg # ES875WDL KA202 EZ # 040349

Mfg # ES875WDLKD EZ # 040350

750 = 3/4" 875 = 7/8"



DVRs

1/3" Day/Night Digital Color Camera

- 1/3" color CCD pick up device
- 480 TV lines horizontal resolution
- NTSC or PAL system
- Lens sold separately
- High rez color camera in bright light & B/W in low light



Mfg # EJEQ500 EZ # 084958

1/3" Mid-Resolution DSP Color Digital Camera

- 1/3" interline transfer color CCD pick up device
- 380 TV lines horizontal resolution
- NTSC or PAL system
- Lens sold separately



Mfg # EJEQ200 EZ # 084960

1/3" Color High-Resolution Weatherproof Camera

- With 3.5-8.0mm vari-focal lens
- 480 TV lines horizontal resolution
- NTSC or PAL system



Mfg # EJEZ350N1 EZ # 084961

4 Channel Digital Video Recorder

- Triplex operation for simultaneously viewing recording and playback
- 4 camera inputs color or B/W
- Stable and reliable non Windows based operating system
- Auto PAL and NTSC format detection
- Built in MPEG1 and JPEG compression/decompression
- Continuous recording, event recording and time lapse recording modes
- 4 alarm inputs/outputs
- Records up to 30 frames per second
- Remote surveillance and control via TCP/IP, LAN, Web browser, WAP phone
- Remote alarm notification via e-mail
- EDR400C - 160 GB 30fps



Mfg # EJEDR400C EZ # 084962

Mfg # EJCDRW KIT EZ # 084963 (CDRW Kit)

16 Channel Digital Video Recorder

- Triplex operation for simultaneously viewing recording and playback
- Stable and reliable non Windows based operating system
- 16 camera inputs color or B/W with loop through
- Auto PAL and NTSC format detection or manual system setting
- Built in MPEG1 and JPEG compression/decompression
- 60 picutres per second global processing rate
- Dual hot-swappable hard drives
- Remote surveillance and control via TCP/IP, LAN, Web browser
- 24 alarm inputs
- 8 alarm outputs
- Remote alarm notification via e-mail
- EDR1602D & EDR1604A - 320 GB 60fps



Mfg # EJEDR1602D EZ # 084964

Mfg # EJEDR1604A EZ # 084965 (with CDRW)

FRP Solution Doors

- Exclusive rugged mortise tenon joint
- Sturdy 6" top rail for ease of installing all standard hardware
- Unmatched adjustable continuous hinge for exceptional support
- Optional Lite kits provided in 3 standard sizes
- Fiberglass reinforced polyester (FRP) withstands the abuse of everyday traffic
- Continuous Aluminum or stainless steel trim caps
- Stabilizing mid-rail for reinforcement and ease of mounting panic devices
- Dense urethane foam core
- Adjustable lock edge fastening system for hard-to-fit existing frames
- 5" side rail reinforcement for installing hardware



Mfg#	Description	EZ #
ECSSD 300700 BRZ BRZ	FRP dark bronze 3' x 7'	067005
ECSSD 300700 GRY ALM	FRP light gray 3' x 7'	067006

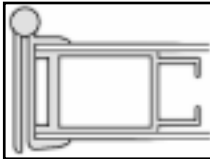

Brown door has duranodic dark bronze aluminum trim and with adjustable continuous hinge.

Light Grey door has clear anodized aluminum trim with adjustable continuous hinge.

Vision lite Kits

- 10" x10" view lite

Mfg#	Description	EZ #
ECFRP V4 0 A	View lite kit, aluminum	067011
ECFRPV4 0 B	View lite kit, bronze	067012



*FRP door
With
View Lite*

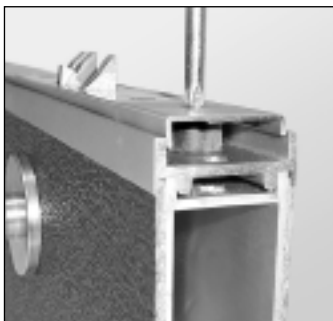

The adjustable lock edge fastening system allows the installer an additional 3/8" width adjustment on top of the 3/8" available adjustment given on the hinge side of the door for a total of 3/4" width adjustment when installing hard-to-fit existing frames.

Y Series Locksets

- Trim: Roses are wrought brass or bronze installed over wrought steel reinforcing plates. Knobs/Levers are brass or bronze.
- Mechanism: Cold rolled steel, zinc plated & dichromated for rust resistance. • Door Thickness: 1 3/8" to 1 3/4" doors.
- Handing: Reversible. • 1577G keyway. • Latches: 1/2" throw, UL Listed. • ANSI A156.2, Series 4000, Grade 2.
- Will accept Ilco, LSDA Peaks, Primus and Assa replacement cylinders.

Mfg#	Function	Fin	Backset	EZ #
FAY101DG26D	Passage	26D	2 3/4"	003710
FAY301DG2 3/4UL26D	Privacy	26D	2 3/4"	028864
FAY521DG10B	Entrance	10B	2 3/4"	040416
FAY521DG626	Entrance	26D	2 3/4"	035432
FAY581DG2 3/4UL26D	Storeroom	26D	2 3/4"	028866



Y Series I.C. Core Locksets Less I/C Core

Mfg#	Function	Fin	Backset	EZ #
FAY521DG IC26D	Entrance	26D	2 3/4"	003714

Will Accept All Best Type I/C cores.

B Series Locksets

- Trim: 3 1/2" roses are heavy wrought brass or bronze installed over steel rose inserts, which are through-bolted through door. Levers are made of pressure cast material.
- Mechanism: Cold formed steel, zinc plated & dichromated for rust resistance. • Door Thickness: 1 3/8" to 2" doors.
- Handing: non handed. • Latches: 1/2" throw, UL Listed. • ANSI A156.2, Series 4000, Grade 2.

Mfg#	Function	Fin	Backset	EZ #
FAB511D626	Entry/Office	626	2 3/4"	070052



B Series I.C. Core Locksets Less I/C Core

Mfg#	Function	Fin	Backset	EZ #
FAB511D IC626	Entry/Office	626	2 3/4"	070044
FAB581D IC626	Storeroom	626	2 3/4"	070045

For 6 or 7 pin cores. Will Accept All Best Type I/C cores.

T Series Locksets

- Trim: Roses are heavy wrought brass or bronze installed over pressure cast rose inserts which are through-bolted through door.
- Mechanism: Cold rolled steel, zinc plated & dichromated for rust resistance. • Latches: 9/16" bolt projection, UL Listed.
- Door Thickness: Accommodates 1 3/4" to 2 1/8" doors. • Handing: non handed. • ANSI A156.2, Series 4000, Grade 1.

Keyed Locks Stocked Less Cylinder

Mfg#	Function	Fin	Backset	EZ #
FAT101D26D	Passage	26D	2 3/4"	066732
FAT301D26D	Privacy	26D	2 3/4"	066739
FAT511D10B LC	Entry/Office	10B	2 3/4"	066720
FAT511D26D LC	Entry/Office	26D	2 3/4"	066718
FAT561D26D LC	Classroom	26D	2 3/4"	066723
FAT581D26D LC	Storeroom	26D	2 3/4"	066727



T Series I.C. Core Locksets Less I/C Core

Mfg#	Function	Fin	Backset	EZ #
FAT511D26D IC	Entry/Office	26D	2 3/4"	066705
FAT561D26D IC	Classroom	26D	2 3/4"	066708
FAT581D26D IC	Storeroom	26D	2 3/4"	066710

For 6 or 7 pin cores. Will Accept All Best Type I/C cores.



D Series Deadlocks

- Trim: Outer trim is pressure cast material with wrought brass cover.
- Door Thickness: 1 3/8" to 1 3/4"
- Latch: 1" throw with 1/4" hardened security roller
- Certification: ANSI A156.5, Grade 2, Accepts 6 pin cores
- Stocked less 6 pin core

Mfg#	Desc.	EZ #
FAD841IC26D FIC6	Sgl Cyl	043074
FAD831IC10B FIC6	Dbl Cyl	040411
FAD831IC26D FIC6	Dbl Cyl	028661

Will accept all Best type 6 pin I/C cores.



S Series Locksets

Certification: ANSI A156.5, Grade 2

Mfg#	Function	Fin	Backset	EZ #
FAS511HG10B 5164P6	Entry/Office	10B	2 3/4"	040421
FAS511HG26D 5164P6	Entry/Office	26D	2 3/4"	040422
<i>IC Core Locks (sold less core)</i>				
FAS511TG IC26D 5164	Entry/Office	26D	2 3/4"	040427
FAS581TG IC26D 5164	Storeroom	26D	2 3/4"	040430

IC - Will accept all Best type I/C cores. For 6 or 7 pin I/C cores
5164 = ASA (4 7/8" Strike)



Stocked Less
I/C Core



D Series Deadlocks With Indicator

Used in conjunction with a regular hotel or motel guest room lock. When locked from inside the room, a deadbolt locks the door and a visual OCCUPIED sign appears in the face of the lock on the outside of the door. Deadbolt can only be operated by the guest when he is in the room. When bolt is retracted, message reads vacant.

Mfg#	EZ #
FAD871 605 2 3/4	080603
FAD871 626 2 2/4	035400
<i>Emergency release tool</i>	
FAA30155 000 00	062590



Latches

Latches - For F Series

Mfg#	Description	EZ #
FA3003500D 26D	2 3/4" Deadlatch	040443
FA3102000D10B	2 3/8" Deadlatch	040449
FA3102000D26D	2 3/8" Deadlatch	040452
FA31020000 26D	2 3/8" Springlatch	040451
FA31030000 26D	2 3/4" Springlatch	040454



Latches - For D400 and D800 Series

Mfg#	Description	Series	EZ #
FA74420000 26D	2 3/8" Bolt	F/841	040463
FA74435000 26D	2 3/4" Bolt	F/841	040465
FA84435000 26D	2 3/4" Bolt	F/831	040469



Latches - 1/2" Projection, Standard, UL Listed

Mfg#	Description	Series	EZ #
FA9442500D 26D	2 3/8" Deadlatch	S	040472
FA9443500D 26D	2 3/4" Deadlatch	S	040473



Latches - For T Series

Mfg#	Desc.	EZ #
FAA92320D630	Dead Latch 2 3/8 b.s.	066931

Accessories

Mfg#	Description	EZ #
FA030730 001 30	Tailpiece std 6 pin	066741
FA12637	IC tumbler springs	003773
FA12639 1	IC 6 pin spring cover	040435
FA12639 002 00	IC 7 pin spring cover	078299
FA1573E	Key blank	040476
FA1573G	Key blank	003720
FA1577E	Key blank	003721
FA1577G	Key blank	003722
FAKB628A	IC key blank	003718
FAA30775	Thin Door Adap Kit	066929

Padlock / IC Core

Less 6 Pin I/C Core

Mfg # FA955DLP6 FIC EZ # 040433



6 Pin Interchangeable Cores

(uncombined)

Mfg#	Fin	Kwy	EZ #
FAC646A4	4	A	040436
FAC646A26D	26D	A	035507
FAC646B26D	26D	B	040438
FAC646F26D	26D	F	040455
FAC646H26D	26D	H	040457



310 Series Electric Strikes

- Corrosion-Resistant –Brass faceplate, cast stainless steel case and working parts, stainless steel springs.
- Tamper-Resistant–heavy-duty construction.
- Non-Fail-Safe–Unlocks when energized.
- Solenoid Actuated– May be energized continuously when unlocked.
- Reversible–Non-handed.
- Horizontal Adjustment–To compensate for misalignment.
- U.L. Listed–Standard No. 1034, Burglary-Resistant Electric Locking Mechanisms. 310-2 and 4 NFS are also U.L. listed as fire door accessories with a 3-hour (A label) rating.
- BHMA Standard 501, Grade 1 Electric Strike.

For use with locks having 1/2" or 5/8" bolt throw (without deadbolts)

Mfg#	Func.	EZ #
FR310 2 32D24VDC	NFS	026340

For use with rim exit devices and double door active leaf equipped with surface vertical rod devices having Pullman latch bolts

Mfg#	Func.	EZ #
FR310 4 32D24VDC	NFS	026343



200 Series Electric Strikes

- Incorporates an internally mounted dual voltage solenoid for use with 12 & 24 VAC/VDC
- Built for long life; exceeds 750,000 cycle test
- Durable, die cast body for long life and corrosion resistance
- 1/2" keeper depth
- Reversible–Non-handed.
- Plug connector included

4 7/8" Faceplate with square corners for wood and hollow metal frames

Mfg#	EZ #
FR202NFS 12/24VDC US28	071144



FS – Fail-Safe – locks when energized
NFS – Non fail safe – unlocks when energized
32D – Satin stainless steel

Parts

Mfg#	Desc.	EZ #
FR076 0107 002 12VDC	12VDC pull solenoid NFS	028328
FR076 0107 004 24VDC	24VDC pull solenoid NFS	028329
FR076 0106 002 12VDC	12VDC push solenoid FS	060924
FR076 0106 004 24VDC	24VDC push solenoid FS	026350
FR003 0209 001	Cam spring F/712 & 732 FS	028333
FR076 2002 008	ANSI Faceplate, US32	067018

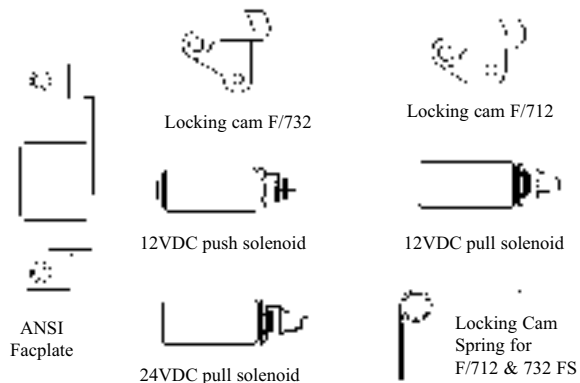



Commercial High Security Safes

Burglary/Fire Safes

- Manufacturers class 350°, 1 hr fire label
- 1/8" thick outside walls
- 1" diameter chrome locking bolts
- Full length locking bar on hinged side of door to prevent entry by removal of hinges
- 1" thick door with 1/2" steel plate
- Heavy duty hinges with bushings
- Hard plate to protect lock from drilling



Mfg#	EZ #	Outside Dimensions (HxWxD)	Inside Dimensions (HxWxD)	Approx. Weight
GDBF1713	065370	21 1/4" x 18 1/4" x 22"	16 1/2" x 13 1/4" x 13 1/2"	355
GDBF2016	065371	25 1/4" x 22" x 24"	20" x 16 1/2" x 15 1/2"	467
GDBF3318	065372	38 1/4" x 23" x 28"	33" x 17 1/2" x 18 1/2"	796
GDBF4524GC	068025	54" x 32 1/2" x 32"	45" x 24 1/2" x 20 1/2"	1,900

Square Tube Safes

Low cost in-floor safes ideal for gas stations, convenience stores, fast food, small businesses and home owners.

FEATURES:

- Square lift out door.
- Group II U.L. listed lock.
- 3/16" electronically rated welded body.
- 1/2" "B" rated door.
- Dust cover for concealing.
- Ship via U.P.S.
- 3/8" x 4 1/2" baffled slot.
- WDS - Baffle Drop Slot



Mfg. #	Outside Dimensions H-W-D	Inside Dimensions H-W-D	Approx. Wt. (lbs.)	EZ #
GDG500GC	8" x 8" x 11 1/4"	7 5/8" x 7 5/8" x 8"	36	003947
GDG700	8" x 8" x 15 1/4"	7 5/8" x 7 5/8" x 12"	42	029382
GDG700WDSGC	8" x 8" x 15 1/4"	7 5/8" x 7 5/8" x 12"	42	003948

Residential Floor Safes

Achieve higher security with flush installation in floor. Easily concealed by a cover or carpeting.

- Group 2 U.L. listed combination lock.
- "B" rated burglary construction
- Hard plate between lock and dial ring
- Full length locking bar on hinge side of door
- Independent relocking device to deter forced entry
- Door frame is reinforced on bolt side
- Coil spring assist on all doors for ease of opening and closing.
- Dust cover included
- 3 active 1" bolts

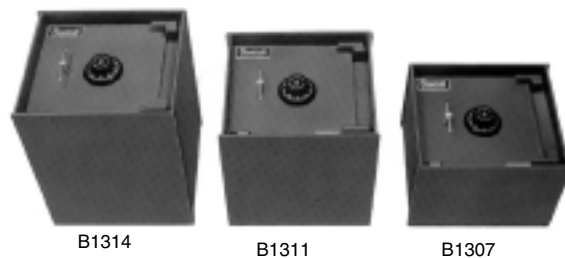

Pyramid Shape
Body for Solid
Anchoring in Floor



Mfg. #	EZ #	Outside Dimensions (H x W x D)	Inside Dimensions (H x W x D)	Cubic Inches	Wt.	Door Size
GDB1307	003931	14 3/4" x 12 7/8" x 11 1/4"	13 3/4" x 12 1/2" x 8 1/4"	1418	92	12" x 12" x 1/2"
GDB1311	043075	14 3/4" x 12 7/8" x 16 1/4"	13 3/4" x 12 1/2" x 13 1/4"	2277	98	12" x 12" x 1/2"
GDB1314	003934	14 3/4" x 12 7/8" x 19 1/4"	13 3/4" x 12 1/2" x 16 1/4"	2793	115	12" x 12" x 1/2"



Front Loading Depository Safes

Rotary Hopper • High Security



RC1237GKK

- CLASS B Insurance rating ½" steel door with punch resistant bolt and relocking device to deter forcible entry. ¼" steel body construction.
- Double Custody Key locks—Requires 2 keys to open door for absolute security.
- Finest quality Group II U.L. combination lock.
- Relocking Device—If back cover is knocked off of lock, the independent relock device is activated, preventing bolt withdrawal.
- Large capacity drop area—2 ½" x 10" x 5" designed to accept most money bags and envelopes.
- Interchangeable Doors—2 sizes 9" x 9" and 12" x 12".

C = Combination lock
K = Dual key lock
E = Electronic lock
KK = 2 dual key locks



RC1218GK



RC1228GC



FL1328GK

Rotary Hopper

Mfg#	EZ #	Outside Dim (HxWxD)	Inside Dim (HxWxD)	Cubic In	Wt.*
GDRC1218GC	003953	18 1/4" x 11 1/2" x 13"	11" x 10 3/4" x 10 3/4"	1271	105
GDRC1218GK	003954	18 1/4" x 11 1/2" x 13"	11" x 10 3/4" x 10 3/4"	1271	105
GDRC1228GC	003955	25" x 14 1/2" x 13"	18 1/4" x 13 3/4" x 10 3/4"	2700	160
GDRC1228GK	003956	25" x 14 1/2" x 13"	18 1/4" x 13 3/4" x 10 3/4"	2700	160
GDRC1237GKK	027705	36 3/4" x 14 1/2" x 13"		4360	220
GDRC1237GCC	003957	36 3/4" x 14 1/2" x 13"	Top 14 3/4" x 13 3/4" x 10 3/4"	4360	220
GDRC1237GCK	040479	36 3/4" x 14 1/2" x 13"	Bot. 14 3/4" x 13 3/4" x 10 3/4"	4360	220
GDRC1237GKC	069738	36 3/4" x 14 1/2" x 13"		4360	220

Front Loading

Mfg#	EZ #	Outside Dim (HxWxD)	Inside Dim (HxWxD)	Cubic In	Wt.*
GDFL1218GC	069733	18 1/4" x 11 1/2" x 13"	11" x 10 3/4" x 10 3/4"	1271	105
GDFL1218GK	069734	18 1/4" x 11 1/2" x 13"	11" x 10 3/4" x 10 3/4"	1271	110
GDFL1328GC	040480	25" x 14 1/2" x 13"	14 1/2" x 13 3/4" x 10 3/4"	2100	165
GDFL1328GK	040485	25" x 14 1/2" x 13"	14 1/2" x 13 3/4" x 10 3/4"	2100	165

*Weights are approximate

Commercial High Security

- Cross locking relocaters
- Punch resistant spindle handle and lock
- Tempered glass relocking trigger
- Bridge mounted lock
- Heavy duty adjustable ball bearing hinges
- 1 1/4" locking bolts

Mfg. #	Outside Dimensions(H-W-D)	Inside Dimensions (H-W-D)	Approx. Wt. (lbs.)	EZ #
GDTL 30 2218	29" x 25" x 26"	22" x 18" x 16 1/2"	1,230	070939





Gun Safes

Mfg#	EZ #	Outside (HxWxD)	Inside (HxWxD)	Wt.*	Style	Color/Trim
* GDBDF6022BSC MT	066305	61" x 22" x 21 1/2"	57" x 17" x 15"	435	Firelined	Black/Silver
• GDBD6022BSC MT	066323	61" x 22" x 21 1/2"	60" x 21" x 17"	360	Non-Fire	Black/Silver
* GDBDF6022HGC MT	066306	61" x 22" x 21 1/2"	57" x 17" x 15"	435	Firelined	Hunter/Gold
+ GDBD6030BSC MT	066302	61" x 30" x 25 1/2"	60" x 29" x 21"	500	Non-Fire	Black/Silver
◇ GDBDF6030BSC MT	066307	61" x 30" x 25 1/2"	57" x 25" x 18"	725	Firelined	Black/Silver
◇ GDBDF6030HGC MT	066308	61" x 30" x 25 1/2"	57" x 25" x 18"	725	Firelined	Hunter/Gold



BD6022



BD6030

6022 Interior Options

Mfg#	EZ #	Desc.	Capacity	Material
* GDBD INT10G	066340	Fire	10 guns	Gray felt
* GDBDGINT10V	066338	Fire	10 guns	Velour
• GDBD INT13G	066336	Non-Fire	13 guns	Gray felt
* GDBDGINT14V	066339	Fire	14 guns	Velour
• GDBD INT19G	066337	Non-Fire	19 guns	Gray felt

6030 Interior Options

Mfg#	EZ #	Desc.	Capacity	Material
◇ GDBD INT12G	066344	Fire	12 guns	Gray felt
+ GDBD INT16G	066341	Non-Fire	16 guns	Gray felt
◇ GDBDGINT26V	066346	Fire	26 guns	Velour
+ GDBDGINT32V	066343	Non-Fire	32 guns	Velour

When Choosing Options:

options marked with a * can only be used with safes marked with a *
 options marked with a • can only be used with safes marked with a •
 options marked with a + can only be used with safes marked with a +
 options marked with a ◇ can only be used with safes marked with a ◇

Money Chest

For storage of cash register drawers. "B" rated construction. Independent relock system and hard plate. Full length locking bar on hinge side of door. U.L. Listed Group 2 lock.

Outside – 28 5/8" x 23 3/8" x 16 1/4"

Inside – 27 7/8" x 22" x 13 3/4"

Cubic Inches – 8277

Approx. Weight – 280 lbs.

Mfg # GDB2815 EZ # 003935



Compact Utility Security Safe

Designed for use in walls, basements, car trunks, RV's. Solid steel plate with insurance class "B" rated construction. Also features a U.L. Listed Group 2 combination lock.

Outside – 10 1/4" x 11 1/2" x 13"

Inside – 9 3/4" x 10 3/4" x 10 3/4"

Cubic Inches – 1126 Approx. Weight – 60 lbs.

Mfg#	Description	EZ #
GDH2C	Combination Lock	003949
GDH2GK	Key Lock	029235



Cash Register Tray Safe with Depository

- Recessed door to help deter pry attacks
- Hard plate around the lock, with independent relocker
- Interiors – 5 fixed location removable shelves
- Anchoring holes in bottom to bolt safe down
- 3 1/4" round bolts and full length dead bolt

Mfg # GDFL2522/5 EZ # 003942

Outside - H-W-D 34" x 22" x 17 1/4"

Interior: Drop compartment with cam lock. 5 fixed location, removable shelves.

Weight: 275 lbs.



Small Depository Safes

Exclusive baffle design prevents contents from being removed through opening. Has independent relocking system, hard plate, "B" rated construction. Locks are U.L. Listed.

Outside – 12" x 6 1/2" x 6"

Inside – 9 1/2" x 6" x 5"

Cubic Inches – 285

Approx. Weight – 35 lbs.

Mfg#	Description	EZ #
GDTC1206K	Key lock	003968
GDTC1206C	Combination	003967



TC1206K



TC1206C



Record safes are designed to provide a comfortable margin of protection against fire. Combination locking system, interlocking door bolts and full locking bar give Insurance Class "B" burglary protection features.

- Hard plate between the Group II lock and dial ring.
- U.L. Listed Group II lock or optional electronic lock.
- Models 1812-3018 carry U.L. 350° 1 hour label.
- Models 3620-4220 carry manufacturer's 2 hour label.
- All record safes have an independent relocking device to deter forcible entry.



1812



4220

Mfg#	EZ #	Outside Dim (HxWxD)	Inside Dim (HxWxD)	Cubic In	Wt.*	Shelves*
GD1812GC	003988	25" x 17 1/4" x 19 3/4"	18" x 12" x 12"	2592	310	*1
GD171718GC	003986	25" x 22 1/4" x 26 1/4"	18" x 18" x 18"	5832	490	*2
GD3018/2GC	003995	37 1/4" x 23 1/4" x 25 3/4"	30" x 18" x 18"	9720	620	*3
GD3620GC	003997	44 3/4" x 25 3/4" x 28 1/4"	36 1/4" x 20 1/2" x 20"	14865	805	*3
GD4220GC	003999	50 3/4" x 25 3/4" x 28 1/4"	42 1/4" x 20 1/2" x 20"	17325	875	*3

*Weights are approximate *Additional shelves available on special order

2-Hour Series

- 2-hour fire label furnace-tested to 1,850°
- Bolt detent
- Shear point handle
- Thick, 4 1/4" pry-resistant door
- Heavy duty hinges
- Center bolt-down hole
- Independent re-locker and hardplate
- 5 active 1" bolts - 3-way boltwork



1812

Mfg#	EZ #	Outside Dim (HxWxD)	Inside Dim (HxWxD)	Cubic In	Wt.*	Shelves*
GD1411/2G	077477	21" x 16 1/4" x 8 3/4"	14"x11"x11"	1693	250	0
GD1612/2G	077478	23" x 17 1/4" x 19 3/4"	16"x12"x12"	2304	298	1
GD1812/2G	077479	25" x 17 1/4" x 19 3/4"	18"x12"x12"	2592	310	1
GD1818/2G	077480	25" x 17 1/4" x 25 3/4"	18"x12"x18"	3888	392	1
GD171718/2G	077481	25" x 23 1/4" x 25 3/4"	18"x18"x18"	5832	490	2

Group II UL Electronic Lock

- 6 digit push button combination.
- Retrofits on all Gardall safes that are handle activated.
- One million possible combinations.
- Easy combination change from the key pad.
- Entering 4 incorrect combinations activates lockout delay. See S & G Section For Locks



S & G 6120

BDK01-0-0 Bolt Down Kit

For use with models 1310-3018

Mfg # GDBOLT DOWN KIT

EZ # 003925



Concealed Wall Safes with Flange

- Recessed into a wall and concealed by a picture or mirror
- Depths 4" and 6"
- Great for hand guns
- Heavier construction than most wall safes on the market (1/4" door, 3/16" body)
- Combination Lock
- 2 mounting holes on each side

Mfg. #	Outside Dimensions H-W-D	Inside Dimensions H-W-D	Approx. Wt. (lbs.)	EZ #
GDSL4000FGC	12 1/2" x 14 3/8" x 4"	12" x 14" x 2 3/4"	41	003960
GDSL6000FGE	12 1/2" x 14 3/8" x 6"	12" x 14" x 4 3/8"	47	061725
GDSL6000FGC	12 1/2" x 14 3/8" x 6"	12" x 14" x 4 3/8"	47	003965



E = Electronic lock



Rim Cylinders

- Solid brass construction
- Accepts original pins when pinning to original master key sytem
- Tailpiece easily converts between horizontal and vertical positions



Mfg. #	Description	EZ #	Mfg. #	Description	EZ #
GMR118AW10B KA2	Arrow kwy	075683	GMR118RA10B KA2	Sargent RA kwy / 6 pin	075689
GMR118AW26D KA2	Arrow kwy	075684	GMR118RA26D KA2	Sargent RA kwy / 6 pin	075690
GMR118CB10B KA2	Corbin 60 kwy	075685	GMR118SC10B KA2	Schlage C kwy	075691
GMR118CB26D KA2	Corbin 60 kwy	075686	GMR118SC26D KA2	Schlage C kwy	075692
GMR118CL4 10B KA2	Corbin L4 kwy / 6 pin	075751	GMR118SCE10B KA2	Schlage E kwy / 6 pin	075693
GMR118CL4 26D KA2	Corbin L4 kwy / 6 pin	075752	GMR118SCE26D KA2	Schlage E kwy / 6 pin	075694
GMR118KW10B KA2	KW1 kwy	075753	GMR118SX10B KA2	Schlage C-K kwy	075695
GMR118KW26D KA2	KW1 kwy	075754	GMR118SX26D KA2	Schlage C-K kwy	075696
GMR118RD1 10B KA2	Russwin D1 kwy / 6 pin	075755	GMR118WR10B KA2	Weiser kwy	075697
GMR118RD1 26D KA2	Russwin D1 kwy / 6 pin	075756	GMR118WR26D KA2	Weiser kwy	075698
GMR118SA10B KA2	Sargent LA kwy / 6 pin	075757	GMR118YA10B KA2	Yale 8 kwy	075699
GMR118SA26D KA2	Sargent LA kwy / 6 pin	075758	GMR118YA26D KA2	Yale 8 kwy	075700
GMR118SAX10B KA2	Sargent LA-LD kwy / 6 pin	075687	GMR118YGA10B KA2	Yale GA kwy / 6 pin	075701
GMR118SAX26D KA2	Sargent LA-LD kwy / 6 pin	075688	GMR118YGA26D KA2	Yale GA kwy / 6 pin	075702

Knob/Lever Cylinders

- Solid brass construction
- Accepts original pins when pinning to original master key sytem
- Comes with 5 tailpieces for most knob, lever and deadbolt applications



Mfg. #	Description	EZ #	Mfg. #	Description	EZ #
GMK001AW4KA2	Arrow kwy	075768	GMK001RA4KA2	Sarg. RA kwy/6 pin	075782
GMK001AW26D KA2	Arrow kwy	075769	GMK001RA26D KA2	Sarg. RA kwy/6 pin	075783
GMK001CB4KA2	Corbin 60 kwy	075770	GMK001SC4KA2	Schlage C kwy	075784
GMK001CB26DKA2	Corbin 60 kwy	075771	GMK001SC26D KA2	Schlage C kwy	075785
GMK001CL4 4KA2	Corbin L4 kwy/6 pin	075772	GMK001SCE4KA2	Schlage E kwy/6 pin	075786
GMK001CL4 26DKA2	Corbin L4 kwy/6 pin	075773	GMK001SCE26D KA2	Schlage E kwy/6 pin	075787
GMK001KW4KA2	KW1 kwy	075774	GMK001SX4KA2	Schlage C-K kwy	075788
GMK001KW26D KA2	KW1 kwy	075775	GMK001SX26D KA2	Schlage C-K kwy	075789
GMK001RD1 4KA2	Russwin D1 kwy/6 pin	075776	GMK001WR4KA2	Weiser kwy	075790
GMK001RD1 26D KA2	Russwin D1 kwy/6 pin	075777	GMK001WR26D KA2	Weiser kwy	075791
GMK001SA4KA2	Sargent LA kwy/6 pin	075778	GMK001YA4KA2	Yale 8 kwy	075792
GMK001SA26D KA2	Sargent LA kwy/6 pin	075779	GMK001YA26D KA2	Yale 8 kwy	075793
GMK001SAX4KA2	Sarg. LA-LD kwy/6 pin	075780	GMK001YGA4KA2	Yale GA kwy/6 pin	075794
GMK001SAX26D KA2	Sarg. LA-LD kwy/6 pin	075781	GMK001YGA26D KA2	Yale GA kwy/6 pin	075795

Mortise T-Turn Cylinders

- Solid brass or die-cast turn piece
- Solid brass housing



Mfg. #	Description	EZ #
GMM100T10B AR	1" thumb turn cyl	075675
GMM100T26D AR	1" thumb turn cyl	075676
GMM118T10B STD	1 1/8" thumb turn cyl	075677
GMM118T26D STD	1 1/8" thumb turn cyl	075678

Mortise Dummy Cylinders

- Non-hollow solid brass construction
- Exact threads



Mfg. #	Description	EZ #
GMM100D10B	1" dummy cyl	075679
GMM100D26D	1" dummy cyl	075680
GMM118D10B	1 1/8" dummy cyl	075681
GMM118D26D	1 1/8" dummy cyl	075682



Mortise Cylinders • Padlocks

Uncombined Cores • Profile Cylinders

Mortise Cylinders

- Solid brass
- Accepts original pins when pinning to original master key sytem



Mfg. #	Description	EZ #	Mfg. #	Description	EZ #
GMM100AW10B KA2 AR	1" cyl Arrow kwy	075703	GMM118AW26D KA2 STD	1 1/2" cyl Arrow kwy	075736
GMM100AW26D KA2 AR	1" cyl Arrow kwy	075704	GMM118CB10B KA2 STD	1 1/2" cyl Corbin 60 kwy	075737
GMM100CB10B KA2 AR	1" cyl Corbin 60 kwy	075705	GMM118CB26D KA2 STD	1 1/2" cyl Corbin 60 kwy	075738
GMM100CB26D KA2 AR	1" cyl Corbin 60 kwy	075706	* GMM118CL4 10B KA2 STD	1 1/2" cyl Corbin L4 kwy	075739
GMM100CL4 10B KA2 AR	1" cyl Corbin L4 kwy	075707	* GMM118CL4 26D KA2 STD	1 1/2" cyl Corbin L4 kwy	075740
GMM100CL4 26D KA2 AR	1" cyl Corbin L4 kwy	075708	GMM118KW10B KA2 STD	1 1/2" cyl KW1 kwy	075741
GMM100KW10B KA2 AR	1" cyl KW1 kwy	075709	GMM118KW26D KA2 STD	1 1/2" cyl KW1 kwy	075742
GMM100KW26D KA2 AR	1" cyl KW1 kwy	075710	* GMM118RD1 10B KA2 STD	1 1/2" cyl Russ. D1 kwy	075743
GMM100RD1 10B KA2 AR	1" cyl Russwin D1 kwy	075711	* GMM118RD1 26D KA2 STD	1 1/2" cyl Russ. D1 kwy	075744
GMM100RD1 26D KA2 AR	1" cyl Russwin D1 kwy	075712	* GMM118SA 10B KA2 STD	1 1/2" cyl Sarg. LA kwy	075745
GMM100SA 10B KA2 AR	1" cyl Sargent LA kwy	075713	* GMM118SA 26D KA2 STD	1 1/2" cyl Sarg. LA kwy	075746
GMM100SA 26D KA2 AR	1" cyl Sargent LA kwy	075714	* GMM118SAX10B KA2 STD	1 1/2" cyl Sarg. LA-LD kwy	075747
GMM100SAX10B KA2 AR	1" cyl Sarg. LA-LD kwy	075715	* GMM118SAX26D KA2 STD	1 1/2" cyl Sarg. LA-LD kwy	075748
GMM100SAX26D KA2 AR	1" cyl Sarg. LA-LD kwy	075716	* GMM118RA10B KA2 STD	1 1/2" cyl Sarg. RA kwy	075749
GMM100RA10B KA2 AR	1" cyl Sargent RA kwy	075717	* GMM118RA26D KA2 STD	1 1/2" cyl Sarg. RA kwy	075750
GMM100RA26D KA2 AR	1" cyl Sargent RA kwy	075718	GMM118SC10B KA2 STD	1 1/2" cyl Schlage C kwy	075760
GMM100SC10B KA2 AR	1" cyl Schlage C kwy	075719	GMM118SC26D KA2 STD	1 1/2" cyl Schlage C kwy	075761
GMM100SC26D KA2 AR	1" cyl Schlage C kwy	075720	* GMM118SCE10B KA2 STD	1 1/2" cyl Schlage E kwy	075762
GMM100SCE10B KA2 AR	1" cyl Schlage E kwy	075721	* GMM118SCE26D KA2 STD	1 1/2" cyl Schlage E kwy	075763
GMM100SCE26D KA2 AR	1" cyl Schlage E kwy	075722	GMM118SX3 KA2 STD	1 1/2" cyl Sch C-K kwy	080565
GMM100SX10B KA2 AR	1" cyl Schlage C-K kwy	075723	GMM118SX10B KA2 STD	1 1/2" cyl Sch C-K kwy	075731
GMM100SX26D KA2 AR	1" cyl Schlage C-K kwy	075724	GMM118SX26D KA2 STD	1 1/2" cyl Sch C-K kwy	075732
GMM100WR10B KA2 AR	1" cyl Weiser kwy	075725	GMM118SX26 KA2 STD	1 1/2" cyl Sch C-K kwy	080566
GMM100WR26D KA2 AR	1" cyl Weiser kwy	075726	GMM118WR3 KA2 STD	1 1/2" cyl Weiser kwy	080567
GMM100YA10B KA2 AR	1" cyl Yale 8 kwy	075727	GMM118WR10B KA2 STD	1 1/2" cyl Weiser kwy	075733
GMM100YA26D KA2 AR	1" cyl Yale 8 kwy	075728	GMM118WR26D KA2 STD	1 1/2" cyl Weiser kwy	075734
GMM100YGA10B KA2 AR	1" cyl Yale GA kwy	075729	GMM118YA10B KA2 STD	1 1/2" cyl Yale 8 kwy	075764
GMM100YGA26D KA2 AR	1" cyl Yale GA kwy	075730	GMM118YA26D KA2 STD	1 1/2" cyl Yale 8 kwy	075765
GMM118AW10B KA2 STD	1 1/2" cyl Arrow kwy	075735	* GMM118YGA10B KA2 STD	1 1/2" cyl Yale GA kwy	075766
			* GMM118YGA26D KA2 STD	1 1/2" cyl Yale GA kwy	075767

* = 6 pin capacity, pinned 5

Uncombined Cores

Mfg. #	EZ #	Mfg. #	EZ #	Mfg. #	EZ #
6 pin					
GMIC6A26D	085288	GMIC6 1C26D	085301	GMCAM2CL	085399
GMIC6B26D	085289	GMIC6 1D26D	085302	GMCAM2SA	085400
GMIC6C26D	085290	7 pin			
GMIC6D26D	085291	GMIC7A26D	085303	GMCAM2SL	085401
GMIC6E26D	085292	GMIC7M26D	085304	GMCAM2ST	085402
GMIC6F26D	085293	GMIC7K26D	082013		
GMIC6G26D	085294	7 pin Housing			
GMIC6H26D	085295	GMICT7 26D	085305	GMIC7	GMIC6
GMIC6J26D	085296	GMICR7 26D	085306		
GMIC6K26D	085297	Adjustable Collar			
GMIC6L26D	085298	GMCOL3 10B	081793		
GMIC6M26D	085299	Cams			
GMIC6Q26D	085300	GMCAM2AR	085398		



IC Padlocks

- Solid body, non key retaining
- Less cylinder



Mfg#	Shackle	EZ #
GMICP1751	1 3/4" x 1"	085307
GMICP1753	1 3/4" x 3"	085308

Profile Cylinders

- Removable pin chamber
- Drilled 5, pinned 5

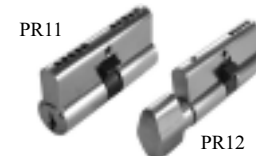

Mfg#	Cylinder	EZ #
GMPR12KW4KD	Single	085309
GMPR11SC26D KD	Double	085310



7000 Series – Modular

The modular design allows the user to change operations between fail secure and fail safe, by the positioning of the solenoid within the unit. The unique design enables the unit to operate under excessive door loading that would normally bind other electric strikes. The 7000 series is designed with a base unit electric strike. Order from the five interchangeable face plates shown below. The internally mounted solenoid provides for easy installation in hollow metal, aluminum and wood door jambs.

Standard Features:

- Field Reversible – Fail Secure / Fail Safe
- Door Loading – Can release under a Pre-load
- Continuous duty operation • Non-Handed • Tamper Resistant
- 12VDC Current Draw – .45 amps • 24VDC Current Draw – .25 amps
- Strike sold less faceplate

HE7000U12D
EZ # 060905
•
HE7000U24D
EZ # 060906



Shown With 701 Option

Use HE2001 plug-in-bridge rectifier for A/C use

701 OPTION

For use with cylindrical locksets, up to 5/8" throw latchbolt.

For ANSI 4 7/8" jamb cutout.
4 7/8" x 1 1/4" x 1 5/8"

Mfg # HE701 630

EZ # 060909

Mfg # HE701 613

EZ # 072254

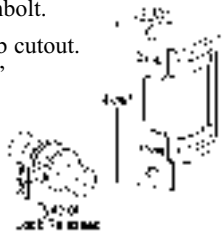

702 OPTION

For use with cylindrical locksets, up to 5/8" throw latchbolt.

For wood or aluminum jamb installations.
7 15/16" x 1 7/16"

Mfg # HE702 630

EZ # 060910

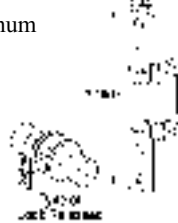

783 OPTION

For use with rim mounted panic exit devices, up to 3/4" throw latchbolt.

9" x 1 3/4" x 11/16" Face Plate
1 1/8" Backset

Mfg # HE783FP626

EZ # 040568

Mfg # HE783 613

EZ # 072255

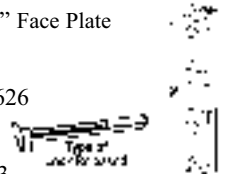

786 OPTION

For use with rim mounted panic exit devices / vertical rod devices, up to 3/4" throw latchbolt.

6 1/2" x 1 3/4" x 1/2" Face Plate
1 1/4" Backset

Mfg. # HE786FP626 EZ #061333

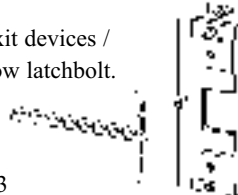

789 OPTION

For use with rim mounted panic exit devices, up to 3/4" throw latchbolt.

9" x 1 3/4" x 1/2" Face Plate
1 1/4" Backset

Mfg. # HE789FP630 EZ # 060911



Accessories for 1006, 5000 & 7000 Series

Mfg. #	Desc.	EZ #	Mfg. #	Desc.	EZ #
HE2001	Plug-in bridge rectifier for AC	004038	HE2009	In line LED	061338
HE2003	M.O.V. with in line plug	069860	HE783SMB	Surface mounting box	069741
HE2005	Smart-Pac II	060126	HE7000 106	Keeper pocket adapter	072265
HE2006	In line buzzer	061339	HE152	Universal mounting tabs	070251



SMART-Pac II™

Enables the electric strike to operate with a variety of voltages, from 12 to 32 volts, AC or DC, while utilizing only one solenoid. Provides electronic regulated current for continuous duty operation without the normal heat build up. Includes an adjustable minimum activation timer which can be set from 2 to 8 seconds, or deactivated. Timer can be activated in both fail secure and fail safe operations. This device has been designed with on board safety features, including an in-line fuse to protect the strike and an M.O.V. to protect the host system from any possible reverse current surges.

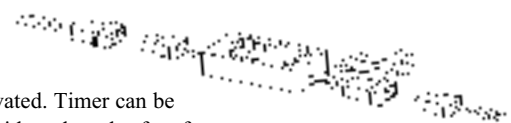



5000 Series – Low Profile Heavy Duty

Designed with a heavy duty stainless steel inner structure to provide strength and durability.

- Forcing strength - 1,500 lbs. • Endurance rating 250,000 cycles
- Compact design 1 1/16" backset • Continuous duty operation
- Plug in connectors • Internally mounted solenoid • Strike sold less faceplate
- Non-handed • Field selectable fail-secure / safe

1" lip extension



Shown With 501 Option

Mfg#	Desc.	EZ #
HE5000 12/24	12/24 volt strike	085085
HE5104 1	Lip Extension	066693

501 OPTION

For ANSI metal jamb installation, Faceplate 4 7/8" x 1 1/4"

Mfg # HE501OPTION630
EZ # 066431

Mfg # HE501 613
EZ # 067339

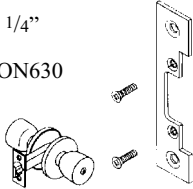

502 OPTION

For flat aluminum or wood installation

Faceplate 4 15/16" x 1 7/16"

HE502OPTION630
EZ # 066434



503 OPTION

For aluminum frame installation Faceplate 6 7/8" x 1 1/4"

HE503OPTION630
EZ # 066435

Mfg # HE503OPTION613
EZ # 073863

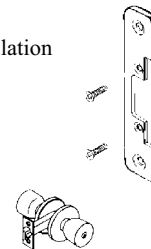

5200 Series – Heavy Duty

Designed with in-frame horizontally adjustability.

- Non-handed • Field selectable fail-secure / safe
- Forcing strength - 1,500 lbs. • 12/24 volt
- Endurance rating 250,000 cycles

Mfg# HE5200 12/24 EZ # 085209



4500 – Low Profile

Designed for installation in 2" UL 10C (3 hour) fire rated frames with the required 1/2" drywall penetration. Accommodates virtually all 3/4" throw cylindrical and mortise locks.

Mfg # HE4500 12/24 613 EZ # 080935
Mfg # HE4500 12/24 630 EZ # 080934



9600 Series – Genesis Surface Mounted

Totally surface mounted, requires no door jamb preparation. Simply place the surface mounted face plate on the door frame, line it up with the latch on the existing rim panic device, mark the mounting holes on the frame and install it! Dual operation (fail safe/secure) and dual voltage (12V/24V AC or DC). Encased in the 9" x 1 3/4" x 3/4" surface mounted faceplate.

Mfg # HE9600 630 EZ # 072790



7500 Series – Heavy Duty

Designed to dimensionally fit into jamb cutout of Folger Adam 712 and 732 and Von Duprin 6211 and 6211WF. 7505 is designed to fit into jamb cutout of Folger Adam 310-2 and Von Duprin 6215 and 6226. U.L. listed for category 10B Fire Door Accessory.

- Tamper resistant – Heavy duty construction • Plug in connectors
- Forcing strength (in opening direction) – 1940 lbs. • Internally mounted solenoid
- Durability minimum – 500,000 cycles • Field reversible - fail secure/fail safe
- Door loading resistance - can operate under a pre-load condition (in fail secure mode only)
- Non-handed • Continuous duty operation • Horizontal adjustment

Mfg#	Volts	EZ #	Mfg#	Volts	EZ #
HE7501 12DC	12	068452	HE7505 12DC630	12	065341
HE7501 24DC630	24	065760	HE7505 24DC630	24	065761





Cabinet Lock

E171 – Adjustable Keeper

Designed with a 1/8" horizontally adjustable keeper to simplify the installation process. The latch cavity accommodates cylindrical locksets with a 1/2" to 5/8" throw (5/8" requires 1/8" door gap) in metal, wood or aluminum jambs.

- BHMA Grade 3 • UL 1034 burglary resistant • Strike depth 1 1/2"
- Fail secure • Non-handed • Plug-in connectors
- Heavy duty construction • Face plates sold separately
- Internally mounted solenoid • Continuous duty operation (DC)

12VDC Fail Secure
Mfg # HEE171 12D EZ # 077381

24VDC Fail Secure
Mfg # HEE171 24D EZ # 077382



ES4 OPTION

For use with cylindrical locksets in ANSI metal jambs with square corners and a flat face plate.

4 7/8" x 1 1/4"

Mfg # HEES4 26D
EZ # 077375

Mfg # HEES4 10B
EZ # 077378



ER6 OPTION

For use with cylindrical locksets in aluminum jambs with radius corners and a flat face plate.

6 7/8" x 1 1/4"

Mfg # HEER6 26D
EZ # 077376



ER7 OPTION

For use with cylindrical locksets in wood or aluminum jambs with radius corners and a flat face plate.

7 15/16" x 1 7/16"

Mfg # HEER7 26D
EZ # 077377

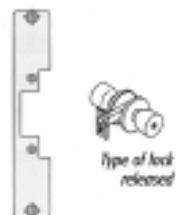

1006 Series – Dual Voltage

Fire rated, heavy duty, for use with cylindrical, mortise, and specialty locksets. Designed for high usage, Grade 1 applications, accommodates all locksets with ANSI 4 7/8" cutout. Accommodates up to a 1" throw.

- Stainless steel construction - corrosion resistant, strong, durable • UL 10C, 3 hour fire rated (fail secure only)
- Dual action solenoid for added security • Tamper resistant interlocking design
- Strongest electric strike in its class • Internally mounted solenoid • Non-handed • Horizontal adjustment
- Continuous duty operation • Strike depth 1 1/16" • Plug-in connectors • 5 year limited warranty

Mfg # HE1006U 12/24VDC BLK (fail secure) EZ # 076672 Mfg # HE1006UF32D (fail safe) EZ # 079464



A OPTION

For use with Arrow, Baldwin, Best and Marks mortise locksets with a normally extended 1" deadbolt without deadlatch.

Mfg # HEA OPTION
EZ # 040546

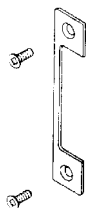

AD OPTION

For use with Sargent, Schlage and Yale mortise locksets with a normally extended 1" deadbolt without a deadlatch.

Mfg # HEAD OPTION
EZ # 040547

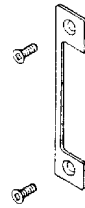

KM OPTION

Specially designed for 92 Falcon M Series and Sargent 7800 and 8200 Series mortise locksets.

Mfg # HEKM OPTION
EZ # 040555

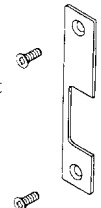

K OPTION

Options normally furnished in 630 finish, unless specified.

For use with Arrow, Baldwin and Marks mortise locksets with auxiliary deadlatch positioned above the latchbolt.

Mfg # HEK OPTION EZ # 040551

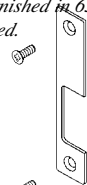

KD OPTION

For use with Sargent, Schlage and Yale mortise locksets with auxiliary deadlatch positioned above the latchbolt.

Mfg # HEKD OPTION EZ # 040554

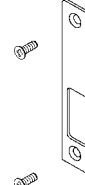

J OPTION

For use with most cylindrical locksets up to 3/4" throw and all locksets with "centerlined" bolts.

HEJ OPTION EZ # 040548

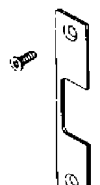

Cabinet Lock

Can be installed vertically or horizontally to accommodate locking bolt. Field selectable fail secure or fail safe, 12 or 24 volt, AC or DC; Current draw .28 amps; surface mounted.

Mfg. # HE650 EZ # 070215

Dimensions
1 29/32" x 1 23/32" x 13/16"





Accessories

Codemax Computerized Code Machine

Equipped with an internal computer chip containing over 800 different depth and spacings which allow it to cut the majority of keys available worldwide. Can handle keys of up to 14 spaces and 14 depths. Comes with 5 cutter wheels (CW-1011, CW-14MC, CW-90MC, CW-20FM and CW-47MC) which allows it to cut almost any type of key and also performs automatic widening of cuts when necessary. Codemax is ready to cut Medeco® brand keys, including Biaxial™. Reference manual makes it simple to look up the proper Depth & Spacing Chart by lock manufacturer, 1200CM card number or by Codemax number.



Mfg # HP1200MAX EZ# 026436

1200CMB Code Machine

The Blitz™ is HPC's upgraded version of the 1200CM Code Machine. It works the same as the 1200CM, but has several added features. Both the depth and spacing shafts have fewer threads per inch, which means that substantially less revolutions are needed to achieve the full range of travel. Other added features include a new flip gauge that is more visible and easier to grasp. Plus, the Blitz™ Code Machine is equipped with a Softie™ deburring brush and a safety shield. Comes with 2 key cutters, CW14MC, CW1011 and CSCD Codesource.

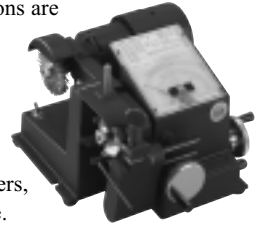

Mfg # HP1200CMB EZ # 025660

Mfg # HPTKA CMB	Tubular Key Adapter Kit	EZ # 077002
Mfg # HPCMB CK	Calibration Kit	EZ # 064176
Mfg # HPCM1083MA	1200CM Machine Belt	EZ # 026402

BLITZ™

9160MC

Perfect for duplicating even the largest of keys, such as hotel/motel keys. Equipped with 4-wax jaws for cutting regular and double-sided keys. Reversible copy dog allows you to cut flat steel keys (with optional slotting cutter kit #CW16KIT). Standard Equipment: CW-23MC cutter, bronze bearings, and Softie brush



Mfg # HP9160MC EZ # 005497

9120RM Compact Speedex

- New Rotary Milling Cutter (Model No. CW-23RM)
- 4 way jaws which allows for cutting a wide variety of keys.
- Lightweight, able to cut regular or large bow keys
- Softie Tylon X Rotary Brush

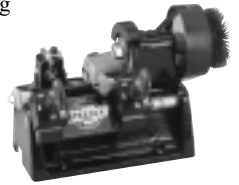

Mfg # HP9120RM EZ # 005496

Power Speedex

Semi-automatic duplicator operated by spring-loaded carriage with safety release. This design allows the carriage to move smoothly with the use of one hand when cutting keys. 4-way jaws enable it to hold a large variety of different key blanks, including double sided keys (foreign automotive keys) and large bow keys (hotel/motel keys).



Motor: 120VAC Weight: 33 lbs
Mfg# HP9180MC EZ # 063501

Switch Blitz

Combines the best of both worlds. It's a Blitz™ code machine combined with a semi-automatic duplicator. Easily switch from code cutting to duplication and back again. Uses the same code cards as your Blitz™ and 1200cm.



Mfg # HP1233CMCSB
EZ # 083052

747E Tubular Key Machine / Scotsman

- Duplicates in any position or depth
- Provides inexpensive standard size tubular key cutting



Mfg # HP747E EZ # 027584

Replacement Carbide Cutter F/747E

Mfg # SM22 01 EZ # 027585

Key Machine Softie Brush

Made of DuPont Tylon-X. The carbide impregnated brush deburrs faster and smoother – lasts 6 times longer than wire. 3" diameter, 1/2" hole.



HPTYX3 EZ # 005324

Thrust Bearings

2 ball bearing units & 4 hardened steel washers for wing nut studs.

Mfg # HPBBW2 EZ # 004573



Key Blocks

Set of 2 blocks for holding Ford double-sided keys when duplicating.

Mfg # HPPFB1 EZ # 004831



Replacement Tip Stop

Mfg # HPCM1054MA EZ # 004680

Standard replacement tip stop for the 1200CM/CMB and the 3333.

Mfg # HPCM1054R EZ # 060613

Use with 7-pin Best & 10-cut Ford on 1200MAX and 1200CM/CMB machines.

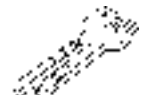
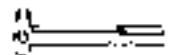



Key Machine Cutters (tool steel mill)

MFG#	O.D.	Thick	Hole	Use	EZ #
HPCW1011	2 3/8"	3/8"	3/8"	1200CM	004700
HPCW1012	2 3/8"	3/8"	3/8"	1200CM	004701
HPCW14MC	2 3/8"	3/8"	3/8"	1200CM	004706
HPCW20FM	2 3/8"	3/8"	3/8"	1200CM	004710
HPCW23MC	2 1/4"	3/32"	1/2"	Speedex	004711
HPCW47MC	2.395"	1/4"	3/8"	1200CM	044510
HPCW90MC	2 3/8"	3/8"	3/8"	1200CM	004728



Replacement Wing Nut

Sturdy blue wing nut is virtually indestructible!
Fits all 1200 Series, Speedex Series and all Trace-A-Key Series (including Automate).

Mfg # HPSNK3 EZ # 005217

Code Cards

MFG.#	EZ#	Desc.	MFG.#	EZ#	Desc.
HPC31X	030382	Kwikset Titan	HPCF215	004653	GM ('94) Modular Ignition Program
HPC101	031045	LSDA LSA keyway	HPCF301	051396	Kia / Hyundai (7 cut)
HPCF65	060933	Mazda/Ford/Mercury	HPCF302	051397	Hyundai (8 cut)
HPCF67	060934	Nissan/Datsun/Subaru	HPCF303	030389	Ford Aspire (Kia) 10 cut
HPCF68	002681	Mazda / Ford 10 Cut	HPCF304	061838	Nissan Pathfinder ('96 +)
HPCF74	030390	Acura (90+) Honda (88+)	HPCF305	070176	Kia (98+) 8 cut
HPCF80	060936	Hyundai/Toyota/Mitsubishi/Isuzu	HPCF306	069693	Mitsubishi Galant (99+)
HPCF85	002694	GM-Chevy/Isuzu/Mitsubishi	HPCF307	076526	Toyota (01+)
HPCF87	040262	Toyota 8 Disc	HPCPKS1	004689	Kaba 140
HPCF88	002696	Toyota/Geo/Isuzu/Suzuki	HPCX32	040255	Hudson Disc
HPCF89	002697	Geo Tracker/Suzuki Sidekick/Isuzu	HPCX56	030396	Ford 10 cut
HPCF205	030385	GM-Pontiac LeMans (1988+)	HPCX58	030397	LSDA Large Pin
HPCF206	002643	GM-Cavalier	HPCX60	030399	Chrysler Double Sided (93+)
HPCF208	002645	Toyota Camry/Corolla/Geo Prizm	HPCX101	060605	Ford 8 Cut (96+)
HPCF209	004651	Toyota Corolla Wagon ('93+)	HPCX102	065362	Chrysler 8 cut
HPCF211	004652	Hyundai Sonata	HPPF301R	060793	Kia/Hyundai(7 cut) (X1-2000, Y7001-8200 series)
			HPPF301L	060792	Kia Hyundai 7 cut (Y1-2000)



Card Holder
Holds 30 cards in the 1200CMB series
Mfg # HP CARD BP
EZ # 035567

CodeSource™ Software

- Instant Access to well over 2.5 million codes
- Search by code, manufacturer, code card number, key blank number, bitting or partial bitting
- Displays Blitz™, Punch Machine™ code card numbers and Code Max™ DSD number
- Displays Micrometer measurements in inches or millimeters
- Displays multiple key blank choices and correct cutter, punch number and jaw
- Allows entry of custom code series and user to add notes to any code series
- Able to print out all code specification screens • Fully compatible with HPC Code Max™

Mfg # HPCSCD CD Format EZ # 065524 Mfg # HPCS35 3 1/2" Format EZ # 062544



KeyChoice™ Software

- References the most popular key blank manufacturers
- Able to search by key blank number, code card number, DSD number, description and hook number
- Able to add, edit or delete keys and hook numbers
- Allows column order to be rearranged for a customized screen layout
- Displays description of key blank application and graphic of keyway
- Print an entire key blank cross-reference chart or selected key blanks

Mfg # HPKC35 3 1/2" Disk Format EZ # 062546





MasterKing™ Software

- Contains a database of more than 150 lock types from more than 50 manufacturers
- Displays change keys, block master, row masters, column masters, page master & TMK in page format
- Supports cross-keying and rotating constants
- Generates 1 - 5 levels in list format
- Handles locks containing 4,5,6,7 or 8 chambers
- Computes driver and control pin in IC systems
- View all of your bitting possibilities before you start entering any information
- Allows printing of bittings, pinnings and pin count
- Interfaces with KeyTrail™ & Compatible with CodeMax™



Mfg # HPMKCD EZ # 074355

KeyTrail™ Software

- Complete management of keys, doors they open and people that hold them, all from one screen
- Utilize “drag & drop” technology to move items
- Easy to understand icons, drop down menus, keyboard shortcuts
- Set up an unlimited number of security profiles for other people who will manage the system
- Generate optional work order to track cylinder installation and key duplication
- Can interface with Masterking™ and CodeMax™



Mfg # HPKT35 3 1/2" Format EZ # 062547

General Code Book Set

6 volume set containing 2000 different code series from the following manufacturers: All Lock, AMC, Arco-Rifkin, Bommer, Chicago, Chrysler, Clum, Corbin, Couch, Crosley, Craftsman, Diebold, Dom, Dominion, Eagle, ESP, Florence, Ford, Fort, GM, Hon, Huwil, Hudson, Hurd, Ilco, Illinois, Ivanhoe, Jeep, Jofco, Kaiser, Kennedy, Lori, Lowe & Fletcher, Loxem, Lockwood, Mack, Metal Rousseau, National, Packard, Pundra, Sargent & Greenleaf, Strattec, Studebaker, Taylor, Teskey, Wayne, Willys, XL, Yale and More.

Mfg # HPHGCB1 EZ # 040543

Domestic Auto Codes

2 volume set which contains over 480 different auto code series. Includes all car code information for cars used within the United States and manufactured or imported by domestic sources. Also contains information from the following manufacturers: AMC, Chrysler, Crosley, Eagle, Ford, GM, Hudson, Hurd, Ivanhoe, Jeep, Kaiser, Mack, Packard, Strattec, Studebaker and Willys.

Mfg # HPHAC EZ # 004873



Foreign Code Book Set

3 volume set containing over 800 different code series from the following manufacturers: Alfa Romeo, Audi, BMW, British Leyland, Capri, Cem, Chrysler, Daihatsu, Datsun, DeLorean, Dom, Eagle, Fiat, Ford, GM, Harley, Hillman, Honda, Hyundai, Isuzu, Iveco, Jaguar, Kawasaki, Kia, Lowe & Fletcher, Mazda, Mercedes, MG, Mitsubishi, Neiman, Nissan, Opel, Peugeot, Renault, Saab, Sipea, Sterling, Sunbeam, Subaru, Suzuki, Toyota, Union, Vauxhall, Volkswagen, Volvo, Yale, Yamaha and Yugo

Mfg # HPHFCB3 EZ # 004878

Car Opening Authority

Multifaceted user-friendly manual that serves not only as a reference book, but also as an educational aid and opening index. Shows you how to open virtually every vehicle for the past 15 years, including all the current cars, vans, SUV's and more. This manual clearly depicts and explains all of the different techniques of the 13 styles of car openings

Mfg # HPCOA22 EZ # 035569



Kekabs

Each HPC Kekab security key control system includes:

- Durable numbered white key tags with reusable snap-hooks.
- Durable steel key racks, slotted to store key tags for immediate identification.
- “Out Key” control tags are yellow paper tags.
- Lock location data consists of an erasable lock location chart as part of the Kekab-8, and numbered key control booklets as part of all other Kekabs.
- Designed to be mounted on a wall, near a desk or work station, or recessed into a wall opening. Heavy gauge steel construction with piano hinged doors and key panels. Kekab-260X, 500 and 730 are equipped with a high security 7 pin tumbler, tubular (round key) lock with popout T - handle. Kekab-8 and all other single-tag Kekabs are equipped with a standard cam lock and two keys.



KEKAB-8



KEKAB-30



KEKAB-330

Mfg#	Key Cap.	Dimensions	EZ #
HPKEKAB8	8	6 5/8" X 5 3/4" X 2"	004977
HPKEKAB30	30	12" X 8" X 2 1/2"	004971
HPKEKAB40	40	12" X 8" X 2 1/2"	004973
HPKEKAB60	60	17" X 13" X 3 1/4"	004975
HPKEKAB80	80	17" X 13" X 3 1/4"	004978
HPKEKAB120	120	17" X 13" X 3 1/4"	004967
HPKEKAB160X	160	20" X 16 1/2" X 5"	004968
HPKEKAB240	240	20" X 16 1/2" X 5"	004969
HPKEKAB260X	260*	25 1/2" X 18" X 5 1/2"	004970
HPKEKAB330	330	20" X 16 1/2" X 5"	004972
HPKEKAB500	500*	25 1/4" X 18" X 5 1/2"	004974
HPKEKAB730	730*	25 1/4" x 18" x 7"	026422

* Denotes Ace keyway popout cylinder with T-handle.

X Denotes expandable

Extra Key Tags for Kekabs

Numbered Tags (stock no. NT-1) packed in a series of 20 numbers (1-20, 21-40, etc.). Plain, unnumbered tags (PLT-1) packed 100 per box. Yellow “Out-Tags” (OT-100) packed 100 per box.

Mfg #	EZ #
HPNT1 1 20	005092
HPNT1 21 40	005095
HPNT1 41 60	005098
HPNT1 61 80	005101
HPNT1 81 100	005103
HPOT100	040544
HPPLT1	005124



Digital Kekabs

Features include 2 levels of access, instant reprogramming, usage indicator and automatic lock-out. Units are battery operated and require no wiring or central processors.

Mfg#	Key Cap.	Dimensions	EZ #
HPKEKAB DL65	65	17" x 13" x 3 1/4"	068222





Graphite

Individual Picks

Mfg #	Size	EZ #
<i>Long Rubber Handle Picks</i>		
HPLPP13	.020	062072
HPLPP20	.020	062073
<i>Diamonds</i>		
HPLPX10	.022	005027
HPHLPX10	.028	004881
<i>Hooks</i>		
HPLPX12	.022	005029
HPHLPX12	.028	004883
<i>Rakes</i>		
HPLPX11	.022	005028
HPHLPX11	.028	004882
HPLPX15	.022	005030
HPLPX16	.022	005031

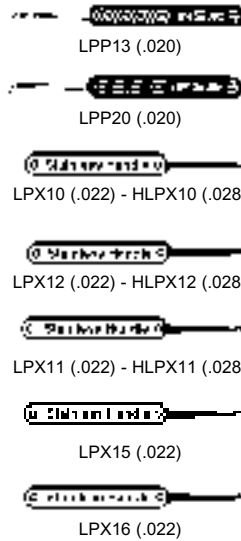

Replacement Pick Gun Needles

Mfg #	Size	EZ #
HPP2	.035	005140
HPP3	.035	005141



Tension Wrenches

L: Light tension
M: Medium tension

Mfg #	Tension	EZ #
HPTR7	L 3 1/4"	005320
HPTR9	L 5 1/4"	005322
HPTR11	L 3 1/4"	005307
HPTR13	M 3 1/4"	005309
HPTR12	L 4 1/2"	005308
HPTR14	M 4 1/2"	005310
HPTR23	M 3 1/4"	005313
HPTR24	M 4"	005314
HPTR25	M 5 1/4"	005315
<i>(Tulip Knob)</i>		
HPTR2	4 1/2"	005311
<i>(Rigid)</i>		
HPTR3	2 1/4" straight	005316
HPTR4	2 1/4" twist	005317
HPTR5	2 3/4" straight	005318
HPVV6	2" dbl sided	005351

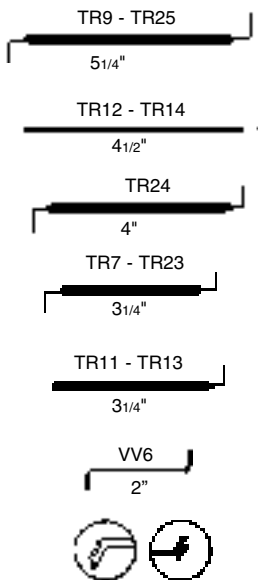

Variable Tension Type

Mfg # HPSTW3	EZ # 005236
--------------	-------------



Double Sided Type

HPTEN7	Medium	EZ # 005265
HPTEN9	Rigid	EZ # 005266

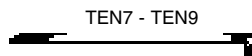

Key Extractors

Mfg # HPEZ1	EZ # 004821
Mfg # HPEZ2	EZ # 004822
Mfg # HPEZ3	EZ # 004823
Mfg # HPEZ5	EZ # 004824
<i>2000 Series Stainless Steel</i>	
Mfg # HPSSX11	EZ # 005233
Mfg # HPSSX20	EZ # 005234

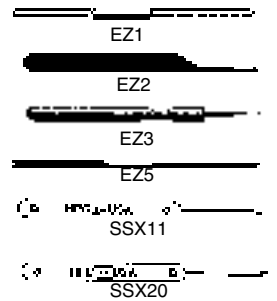

Pick Grip Handle

Foam grip for picks with or without metal handles. Grips tools without any adhesive.

Mfg # HPPICK GRIP	EZ # 035590
-------------------	-------------



Graphite Refill

High quality finest micro-spray refill graphite. One pound can.

Mfg # HPGG16	EZ # 004852
--------------	-------------



Graphite Gun

Use prior to picking or impressing. Loosens tight wafers & pins. Lubricates key machine carriage shaft & wing nut studs.

Mfg # HPHGG	EZ # 004880
-------------	-------------



Electropick

The original cordless rechargeable electric pick gun. It allows the locksmith to duplicate his or her exact raking motion at many times per second. The gun rakes open pin and disc tumbler cylinders using a rapid up and down striking movement, which causes the top and bottom pins to separate, meeting the shear line. The Electropick comes complete with a charger (for bench or wall mount), 4 raking tools and 2 tension tools

Mfg # HPEPG1	EZ # 004811
--------------	-------------



Double Sided Disc Tumbler Lock Picks

Set of 4 picks can be used on the most popular double-sided, disc tumbler, showcase, cam and padlocks.

Mfg # HPDSP1	EZ # 004808
--------------	-------------





Model B

Upgraded model of the TLP-C. The rubber bands have been eliminated by the employment of a collet and o-ring. Permits infinitely variable tension against the feelers. Comes in a genuine leather case with TKPD-1 decoder.

Mfg # HPTLPC MODEL B EZ # 035599



Padlock Shim Picks

20 piece asst. opens laminated type padlocks quickly. Will open almost any lock with a flat top body, providing there is not a deadlocking latch and enough clearance to allow the shim to operate. Contains 5 each of the most common shackle diameters.

Mfg # HPPSA20 EZ # 005126



Extractor Set

Designed to slide next to broken keys along the side mill and ride along the bottom pins to hook into a cut in the key. Made of high grade stainless steel and can be bent to reach around many obstacles.

Mfg # HPES2000 EZ# 004816



Changeable Vise Head Extractor Set

4 changeable blades stored inside a hollow handle. Includes 1 saw type extractor blade, 2 round extractors. .040" diameter and 1 round extractor, .050" dia.

Mfg # HPEZ6 EZ # 004825



Replacement Blades

Mfg # HPEZ7A EZ # 004826

Mfg # HPEZ7B EZ# 004827

Mfg # HPEZ7C EZ# 004828

Mfg # HPEZ7D* EZ # 004829

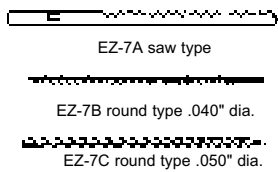

*Asst of 10 blades; 2 ea. of EZ-7C & 4 ea. of EZ-7A/B

Pin Tumbler Tweezers

Mfg # HPPTT4 EZ# 005127

Groove in the tip provides a firm, non twisting grip on cylinder pins for easy loading.

Mfg #HPPTT5 EZ # 005128

Shorter version that allows you to get closer to the action. Only 4" (10cm) long.

Mfg # HPTPT5 EZ# 005300

Comes with pin pushing attachment that makes it easier to load top pins into cylinder

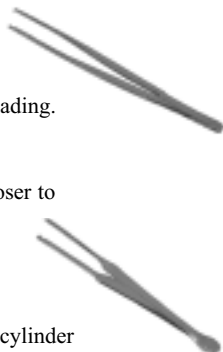

Deluxe Pick Set - 16 Piece

- Shirt pocket size
- Genuine leather case / full zipper
- Picks, tension tools, extractors

Mfg # HPNDPK EZ # 005059



Superior Pick Set - 32 Piece

- Shirt pocket size
- Genuine leather case / full zipper
- Picks, tension tools, extractors

Mfg # HPNDPK32 EZ# 005061



Professional Pick Set - 60 Piece

- Jacket pocket size
- Genuine leather case / full zipper
- Picks, tension tools, extractors

Mfg # HPNDPK60 EZ# 005062



Novice Pick Set - 11 Piece

Contains picks, tension wrenches and a broken key extractor.

Mfg # HPIIP13 EZ# 005117



Tyro Pick Set - 9 Piece

Contains picks, tension wrenches and a broken key extractor.

Mfg # HPIIP15 EZ# 005118

I.D. Badge Pick Set

Pocket on back of case contains identification card with space for a photo or thumbprint of owner. Contains 4 foam grip handled picks and extractors, 4 stainless steel handled picks, 2 tension tools and a set of 4 double sided picks for disc tumbler locks.

Mfg # HPIIP23 EZ # 026431



Jackknife Pick Set

Complete compact pick set to use on pin tumbler locks. Contains 2 rakes, 1 diamond, 1 hook and 1 tension wrench. It folds up and fits in your pocket.

Mfg # HPJKP5 EZ # 004950

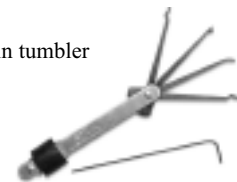

Warded Padlock Pick Set

This compact pick set efficiently opens warded padlocks. Avoid costly destruction of padlocks with this convenient set.

Mfg # HPPKS EZ # 005122





Door Hardware

Emergency Key Box

These bright red steel boxes are specifically designed to house restricted door or elevator keys at the immediate location of the restricted entryway. The Emergency Key Box features a plexi-glass window which may be broken with the attached hammer for immediate access in emergency situations. 6 5/8" x 5 3/4" x 2"



Mfg # HP511 EZ # 005478

Replacement Plexi-Glass Only

Mfg # HP511 GLASS EZ # 026435

Give-Away Key Rings

These key rings are manufactured from hardened spring steel wire and bright zinc plated to resist tarnishing.

Mfg #	Desc.	EZ #
HPGAK3	5/8" Dia.	004849
HPGAK4	3/4" Dia.	004850
HPGAK6	1" Dia.	004851



Large Key Rings

Made of half-hard steel, bright nickel plated. Brass fastener, screws either to left or right.

Mfg #	Desc.	EZ #
HPLKR6	6" Dia.	005021
HPLKR8	8" Dia.	005022
HPLKR11	11" Dia.	005020



Utility Tags

These metal rim tags are manufactured from heavy stock with a smooth writing surface. Each tag has an attached string, looped and knotted. Packed 100 per box.

Mfg #	EZ #
HPERD1	004813
HPERD2	004814
HPERD3	004815



Lightweight Fiber Tags (packed 100 per box)

Mfg #	EZ #
HPEYR7	004818
HPEYR5	004817
HPEYS8	004820
HPEYS6	004819

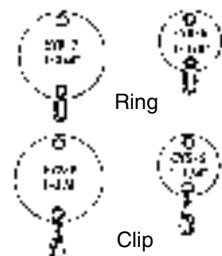

"Do Not Duplicate" Stamp

Made of heavy duty steel stock - hardened and flash-chromed.

Mfg # HPLDND EZ# 005014



3/8" x 5/8"

Offset Guard Plates

For Doors Opening Out and with a Door Casing

For doors that are not flush with the frame. Made of heavy gauge steel and bright nickel plated.

1/4" Offset

Mfg # HPOVDG11 EZ # 005108

3/8" Offset

Mfg # HPOVDG12 EZ # 005109

7/16" Offset

Mfg # HPOVDG13 EZ # 005110

9/16" Offset

Mfg # HPOVDG14 EZ # 005111

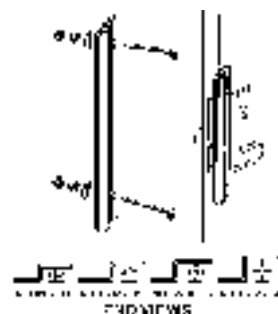

King Size Guard Plates *For Doors Opening Out*

14" long and made of two welded pieces of steel. Offers maximum resistance to prying and forcing. Mounted onto door with 2 carriage bolts and 4 wood screws, going through the door and anchored with a nut and cap nut on the inside. Baked Dark Brown Enamel.

Mfg # HPVDG10 EZ # 005337



Real Estate Key Keeper

Box is placed over the top edge of a door. When door is closed, top mounting screws are hidden.

Piano hinged door. 3 1/4" x 2 1/2" x 2".

18 gauge steel.

Mfg # HPKEP12KA3395 EZ # 004981



Guard Plate *For Doors Opening Out*

Screwed directly on the edge of the door.

The flange will keep any prying tools away from the latch.

Mfg # HPODG6 EZ # 005106



Key Blank Inventory Control Tags

Mfg # HPINV1 EZ # 004946



Brass Key Shim

Helps prevent hard to hold keys from tilting. For use with Codemax™ and Blitz™ machines

Mfg # HPKBPS1 EZ # 069328





Slim Jim

The entry tool by which all others have been judged since its introduction in 1967.

Mfg # HPCO10 EZ # 026406



Super Jim

Wider and faster than CO-10 on many models.

Mfg # HPCO11 EZ # 026407



Big Jim

For the "X" type GMs but opens almost every vehicle that the CO-10 will.

Mfg # HPCO24 EZ # 026410



Chevy Beretta

Designed to unlock the Beretta in a time span of 30 seconds.

Mfg # HPCO59 EZ # 026415

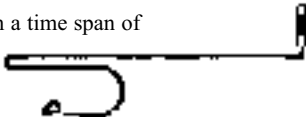

Caddy Killer

Similar to the CO-59, but has increased height in the arc. It can open Cadillac Eldorado, Acura, Honda, Buick, Lexus and many others.

Mfg # HPCO60 EZ # 026416

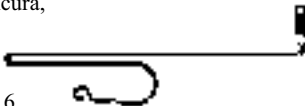

Safari-Joe

Designed to open the following GM models Beretta, Chevette, Corsica, Impala, Malibu, Nova. Dodge models: Charger, Dart and Daytona. Toyota models: Camry, Celica and Supra. It has a slip resistant coating to help bind and move linkages.

Mfg # HPCO62 EZ # 027932

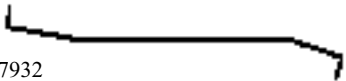

Stretch Killer

Opens Buick Regal, Century, Pontiac Sunbird & Bonneville, Ford Escape, Focus and more.

Mfg # HPCO61 EZ # 027889

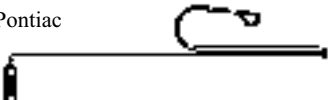

Lasso

Made with "poly-flex" material. Great for luxury cars where metal tools can damage the finish.

Mfg # HPCO73 EZ # 035568



Super Killer™

With its extra length and great strength, can be used to open a wide variety of vehicles. The CO-70 can open many new vehicles, especially GMs, Mercury and Hondas.

Mfg # HPCO70 EZ # 029615

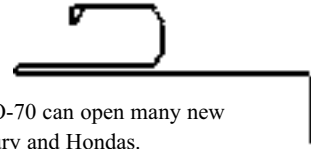

Horizontal Clutch

This tool will help to simplify the "in the door" method of vehicle entry.

Mfg # HPCO75 EZ # 060405



Vertical Clutch

Same as HPCO75, but used on vehicles with vertical linkage.

Mfg # HPCO76 EZ # 060406



5 Foot Super Snare

Goes where no other car opener has ever gone before! Grabs keys, pull up buttons and more.

Mfg # HPCO78 EZ # 067614



Starter Killer Kit

Ideal for beginners or locksmiths needing a small kit for a second service vehicle. Kit includes: CO-11, CO-22, CO-39, CO-61 and two ultimate auto wedges (AW-38).

Mfg # HPAKK55 EZ # 035565



Instant Explorer Tool

This new tool is designed to open a Ford Explorer in seconds!

Mfg # HPC079 EZ # 067804



Switch Stick

Enters into a car by gently pulling up a button or pulling open a lever. Tool can be bent to reach lock.

Mfg # HPC080 EZ # 069946

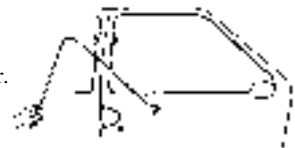

Clip Removal Tool

For door handles and window cranks.

Mfg # HPAST3 EZ # 004559





GM Tumbler Decoder Gauges

Simply press inward on the side bar and rake the tumblers, until the side bar moves inward to the unlocked position. Then, place gauge pin over each wafer until the shoulder stop butts against the top of the plug.



Mfg # HPGMTD5 EZ # 004864

Ford Ignition Drill Template

Allows removal of side-bar so that replacement can be done almost immediately. Accuracy is ensured by use of a key blank as a guide.

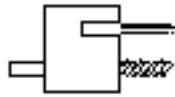

Mfg # HPITF14 EZ # 004948

Clip Removal Tool

Tapered end of this tool enters between the door and trim pad and persuades the pad off.



Mfg # HPAST4 EZ # 004560

Auto Door Panel Clip Removal Tool

Offset design combined with a longer handle allows you to reach clips toward the center of the panel. Saves time and work on both foreign and domestic models.



Mfg # HPAST5 EZ # 004561

Steering Column Lock Plate Compression Kit

Simply screw the center posts threading onto the steering shaft & place the yoke over it. Turning inward on the center post nut compresses plate. Re-install ring by sliding it down tapered shank of the center post screw & back into groove. Includes 14mm screw required for 1978 & on GM products.



Mfg # HPSWLPC1 EZ # 005249

AutoSleeve

Ideal for separating weather stripping from door frames or windows without damage.



Mfg # HPAS1 EZ # 067803

Air Wedge

Slide between the door frame and weather stripping, squeeze the pump to separate the door from the frame.



Mfg # HPAW99 EZ # 065951

Ultimate Auto Wedges

Designed for smooth, safe insertion without risk of dropping into the door cavity. The "illumination hole" allows nearly any flex light to pass through and focus directly on the desired location.

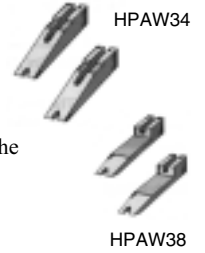

Mfg # HPAW34 3/4" EZ # 004570
Mfg # HPAW38 3/8" EZ # 004571

Gateway Tools

Acts as a third hand to hold open the dust cover on auto door locks.



Mfg # HPGTO EZ # 004865

Lock Plate Compressor

Specially designed lock plate compressor for tilt and telescopic columns used on GM (pre '78).



Mfg # HPSWLPC2 EZ # 005251

Nose Puller

Heavy wrought and bar steel set expertly machined and finished to pull out a lock core. Turn screw into center of core's keyway to act as an anchor. Slip spacer block in place and tighten by turning knurled knob. Continue turning clockwise, slowly and gradually until entire core is drawn out. Use the guard key and disengage bolt.

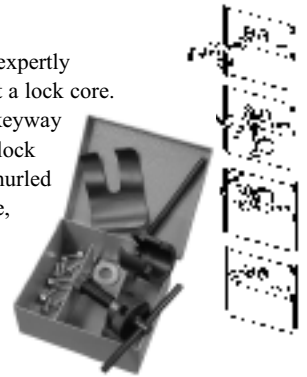

Mfg # HPNP4B EZ# 005089

Door Puller for Safe Deposit Boxes (with NP4B nose puller)

After lock core has been pulled and use of guard key has not opened the door, apply the Door Puller set. Place the stepped spacer block onto the hook unit. The three different diametered steps make it adaptable to three

different sizes of plug bores. Place the correct diameter step into the corresponding bore. Have the hook end set against the inside back wall of the door, then tighten the knurled knob to hold hook in place. Flat surface on the outside of the hook unit should be in a level position. The long flat blade is then fitted onto the holding slot, along with the remainder of the Puller unit, as shown above. Position feet of Puller unit onto "Rebates" (partitions between boxes) or away from centers of adjacent doors, so as to minimize the possibility of distortion. Knurled nut is then turned until the door is pulled out.



Mfg # HPDP7B EZ# 004807



Plug Followers

These four plug followers will fit 99% of the rim or mortise cylinders and cylinder units currently in use. Made of centerless ground bar stock.

Mfg #	Dia	EZ#
HPSUT0	.395"	005238
HPSUT1	.495"	005239
HPSUT3	.500"	005245
HPSUT10	.550"	005240



Adjustable Follower

Fits all standard locks .495" to .600" in diameter. It will handle 90% of all locks. Spring loaded.

Mfg # HPSUT22 EZ# 005242



Hollow Brass Follower Set

Contains three popular sizes of medium hard, zinc plated, hollow brass followers. Each fits into the other.

Mfg # HPSUT14 EZ# 005241



Flex-A-Light™

- More flexible than bending lights, yet rigid enough to keep straight, a must for car opening use
- Halogen light
- No switches to fail
- 36" extension
- Very compact for carrying
- Power handle can clip to your pocket or belt

Kit Includes:

- 10" & 15" lights
- Power Handle
- 36" Extension
- Suction Cup



Mfg # HPFAL25 EZ # 028068

Adjustable Plug Holder

Adjusts hole size from .350" to .600" to give a perfect fit on many different cores. Body and slide are hardened and have a black oxide finish.

Mfg # HPSUT600 EZ# 026432



Solid Plug Holder

Holder is made of hardened bar stock, which prevents it from being scratched by the file.

Mfg # HPCPH10 EZ# 004686



Truarc Ring Spreader/Compressor

Two pivot centers - dual operation.

Mfg # HPTRU55 EZ# 005305



Truarc Ring Compressor

Mfg # HPTRU121 EZ# 005301

Truarc Ring Spreader

Mfg # HPTRU122 EZ# 005302



90° Truarc Ring Compressor

Mfg # HPTRU123 EZ# 005303

TRU121 TRU122 TRU123

Cylinder Drill Jigs

Jigs will assure perfect alignment on shear line for a drill bit.

Mfg # HPCDJ1 EZ# 026403

Cylinder drill jig and drill bit for flat face cylinder

Mfg # HPCDJ2 EZ# 004648

Cylinder drill jig and drill bit for recessed tulip design types



Tubular Lock Saws

Destroys the pins at the shear line. Hole saws available for standard keyways. Fits 1/4" electric drill. Saw life is approx. 3 openings. Not for use on locks with hardened pins or ball bearings in the keyway.

Mfg #	Desc.	EZ#
HPAG1	Standard size tool w/extra saw	004547
HPG1	Replacement saw for AG-1	004872



Mortise Cylinder Tap & Die Set

Complete tap & die set with cylinder holding fixture and metal box.

Mfg # HPCLTD5 EZ# 004672

Re-tapping Tap

Mfg # HPCLT4 EZ# 004673

Metal Punch and Die Set

For 18 gauge or lighter sheet metal.

Mfg # HPHDPS4 EZ# 004876



Multiple Cavity Plug Holders

Holder bodies are hardened and have a black oxide finish.

Fits the five most popular sizes (404, .504, .508, .512, .556)

Mfg # HPCPH5 EZ# 004687

Mfg # HPCPH9 EZ# 004688

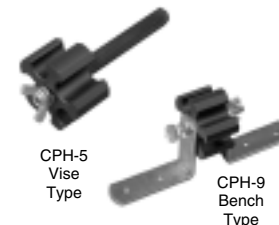

Secured Series

Networkable, single-door controllers allow flexible yet powerful, full-function access control. Up to 500 users

Mfg#	Description	EZ #
IESSHC500P	Hub Plus control	067348
IE0295037	Hub Minimax	069789
IESS SFTWR95	Windows software pkg.	066694
IESSHUB/MAX	Controller w/software	071134
IESSHUB/MAX MOD	Add-on module for Hub/max	071135



Hub Plus control



ProxCARD II

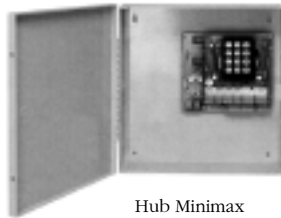

Hub Minimax

Door Guard Lockset

- 120 individual user codes
- ANSI 156.2 Series 4000 Grade 1 Standards
- UV cured weather shield

Mfg # IELS1 26D EZ # 076650



Ruggedized

- Weatherproof self-contained metal housing
- Vandal resistant • 4 On-board relays
- One piece housing suitable for wall post or gooseneck mounting

Mfg # IE212R EZ # 005629



Partitioner Intrusion Control Keypad

- Self contained 2 zone control
- Power/status/armed LED's
- E/E delay - 1-980 sec.
- Relay output - 10-900 sec.

Mfg # IE262B EZ # 085164



Secure Keypad

- "Stealth" viewing window hides PIN from others
- Silent scrolling PIN input prevents counting key inputs
- Touch sensitive keyless design won't wear out

Mfg # IESS/WG Q15 EZ # 069944



Keypad System

Mfg#	Desc	EZ #
IE212I	Indoor	005627
IE212IL	Indoor Lighted	069943
IE212IL/W	Indoor/Outdoor	071137
IE212ILM AL	Mullion Keypad	074329



ProxPoint Proximity Reader

- Weather proof
- Size: 1.7" x 3.135"

Mfg # IESSPROXPNTBK EZ # 069942



Prox.Pad

- Relay or Wiegand output
- Reader able to be remotely mounted from controller
- Weather resistant • 2000 user • Audit Trail

Mfg # IEPROX PAD EZ # 072294



Magnetic Stripe Card Reader

- Weatherproof
- Works with ANSI standard Track II encoded magnetic-striped card
- ATM feature for cash machine access.

Mfg # IESS CR500W EZ # 060400



Sealed Environmental Keypad System

- Weatherproof self-contained metal housing
- Vandal resistant
- Small design suitable for residential, commercial and industrial applications
- 4 On-board relays

Mfg # IE212SE EZ # 005630



Ruggedized Keypad

- Weatherproof self-contained metal housing
- Vandal resistant
- 120 users
- 1 to 6 digit codes, digits may be repeated.

Mfg # IESS KP500R EZ # 060399



MultiPad

- Contemporary design
- Illuminated keys
- Indoor/outdoor construction, weatherproof

Mfg # IE212MP EZ # 065221



Accessories

Mfg#	Description	EZ #
IEPIP12VDC	12VDC plug in power supply	068440
IEPIP24VDC	24VDC plug in power supply	068441
IEMAGCRD25	25 pack magnetic stripe cards	066695
IEPROX KEY FOB	Proxkey HID FOB	069945
IEPROXCARDII	Proximity card	071136



12VDC plug in



Mini-Mite Portable Manual Machine

- Measures only 8" x 5 1/4" x 4" and built tough.
- Reversible vises for both single and double sided keys.
- High speed motor cuts keys in seconds.
- Carriage accepts all size key blanks, including large head.
- Equipped with 23RF Rotary File cutter.
- Special, four sided key rake for deburring keys.
- Hood covers moving parts and meets OSHA requirements.



Mfg # IL008 EZ # 006595

Manual Key Machine

- Wide spacing between vise jaws; accommodates new longer key types.
- Dial type depth adjustment system, simplifies calibration, improves accuracy.
- Ideal for mobile use; efficient 1/4 Hp motor which will operate with most invertors and generators with 500 watt or higher output (115 volt AC).
- Special device guards against cutter contact with vise jaws.



Mfg # IL045 EZ # 070700

Semi-Automatic Key Machine

- Designed to handle keys with large bows or long blades. Automatic machine that can be used manually when needed.
- Machine cover is constructed of high strength, impact resistant material.
- Retains efficient 1/4 Hp motor which operates with most invertors and generators with 500 watt or higher output (115 volt AC).
- Super Jaw 2 vises can be set four different ways to hold virtually any key.



Mfg # IL040 EZ # 060046

BRAVO III

Semi-automatic, professional duplicating machine with 4 way jaws, allowing quick and easy duplication of all types of house and car keys.



Volts: 110, Horse Power .25, Cutter RPM: 900, Cutter Dia: 3.15", Cutter: High Speed Steel, Weight: 40 lbs., Dim: 15" x 15" x 11" high

Mfg # ILBRAVO III EZ # 084802

Matrix-S Key Machine

Precision control in all three axis can duplicate laser and dimple style keys with ease. Vise jaws handle wide variety of keys without the need for adapters.



Mfg # SKMATRIX S EZ # 052038

Semi-Automatic Key Machine

- Wide spacing between vise jaws; accommodates new, longer key types.
- Special device guards against cutter contact with vise jaws.
- Dial type depth adjustment system; simplifies calibration and improves accuracy.
- Ideal for mobile use; efficient 1/4 Hp motor will operate most invertors and generators with 500 watt or higher output (115 volt AC).



Mfg # IL044 EZ # 071032

Tubular Key Machine

- Positive indexing.
- Safety switch prevents machine operation when protective cover is open.
- Heavy duty motor operates on 110VAC.
- Special spring located in chuck ejects duplicated key.



Mfg # IL009A110VAC EZ # 006597

Universal II Key Machine

Card type code machine can switch from originating keys for one lock system to another in seconds. "Dial-type" depth adjustment for precise calibration.



Mfg # ILUNIVERSAL II EZ # 080888

Ultracode Key Machine

Automatic calibration, key registration, which allows flexibility in the method of key placement in the jaws and code cutting stand-alone or linked to a PC.



Mfg # SKULTRACODE EZ # 081828

Transponder Detectors

TD3A

Hand held unit that detects transponders concealed in keys for modern electro-mechanical locking systems



Mfg # ILTD3A EZ # 065666

RW2

Self contained unit detects, identifies & programs transponder keys. Also reads codes and displays it on the LED display.



Mfg # ILRW2 EZ # 068252

Silca Diagnostic Device

Tool for adding new transponder keys to a vehicle's central computer. You no longer have to depend on On-Board programming procedures to add keys!



Mfg # ILSDD EZ # 082766

Key Machine Cutters



Team Keys • Door Hardware

Key Machine Cutters

Mfg#	EZ #	Type	Matl.	Dia.	Thick.	Hole	Used for
IL9MC	026459	Milling Cutter	TS	2.875"	.206"	.5"	017, 018
ILP9MC	006218	Milling Cutter	TNC	2.875"	.206"	.5"	016, 017, 018
IL11MC	007013	Milling Cutter	HSS	2.25"	.290"	.5"	024, DL144M
IL16C	007243	End Mill	HSS	3/16"	N/A	N/A	Tubular 009
IL19MC	007277	Milling Cutter	HSS	2.875"	.281"	.5"	2183DM, 2183HM, 010
IL23RF	007297	Fine Milling	TS	2.25"	.25"	.5"	DL 145M, 008
ILX23MC	035667	Milling Cutter	HSS	2.375"	.093"	.5"	DL 143M, 145M
IL34MC	007309	Milling Cutter	HSS	2.25"	.250"	.5"	2585DU, H2584CV, 2184CD
IL37MC	007310	Milling Cutter	HSS	2.25"	.200"	.5"	2585 DU Series
ILSMS45	006270	Side Milling Slotter	HSS	2.375"	.045"	.5"	H2584/5SMS, 2184CD
ILCU11	069867	Milling Cutter	C	3.150"	.196"	.630"	KD40, KD50, KD71
ILCU20	066121	Milling Cutter	HSS	2.375"	.250"	.5"	020, 040
ILCU50A	035666	Miling Cutter	C	3.15"	.137"	.63"	Silca Bravo
ILD400875ZZ	073791	Milling Cutter	HSS	3.15"	.197"	.63"	Silca Bravo / USA

HSS - High Speed Steel
 TS - Tungsten Steel
 TNC - Titanium Nitride Coated
 C - Cobalt

Parts

Mfg. #	Description	EZ #
IL814 00 51	3" dia. Nylon brush	007415
IL815 00 51	6" Nylon brush	007416
IL1 59	Thrust Bearing F/008	026456
IL190 16	008 Belt	007278
ILD301840ZZ	Nylon brush for Bravo	073360



Nylon Brush



Milling Cutter



Side Milling



End Mill

Kwy/Team	EZ #	Kwy/Team	EZ #	Kwy/Team	EZ #	Kwy/Team	EZ #
NHL Keys		NBA Keys		NFL Keys		NFL Keys	
KW1 AVALANCE	080171	KW1 SUNS	080207	KW1 BENGALS	080526	KW1 JETS	080087
SC1 AVALANCE	080170	SC1 SUNS	080208	SC1 BENGALS	080527	SC1 JETS	080094
KW1 COYOTES	080163	MLB Keys		KW1 BILLS	080083	KW1 LIONS	080088
SC1 COYOTES	080162	KW1 A'S	080221	SC1 BILLS	080090	SC1 LIONS	080095
KW1 KINGS	080023	SC1 A'S	080222	KW1 BRONCOS	080191	KW1 PANTHERS	080268
SC1 KINGS	080022	KW1 ANGELS	080211	SC1 BRONCOS	080192	SC1 PANTHERS	080269
KW1 MIGHTY DUCKS	080130	SC1 ANGELS	080212	KW1 BROWNS	080084	KW1 PATRIOTS	080238
SC1 MIGHTY DUCKS	080129	KW1 ASTROS	080230	SC1 BROWNS	080091	SC1 PATRIOTS	080239
KW1 STARS	080173	SC1 ASTROS	080709	KW1 BUCCANEERS	080909	KW1 RAMS	080534
SC1 STARS	080172	KW1 CUBS	080215	SC1 BUCCANEERS	080910	SC1 RAMS	080535
NBA Keys		SC1 CUBS	080216	KW1 CHIEFS	080530	KW1 RAVENS	080911
KW1 CLIPPERS	080203	KW1 DIAMONDBACKS	080213	SC1 CHIEFS	080531	SC1 RAVENS	080912
SC1 CLIPPERS	080204	SC1 DIAMONDBACKS	080214	KW1 COLTS	080528	KW1 REDSKINS	080913
KW1 GRIZZLIES	080231	KW1 DODGERS	080219	SC1 COLTS	080529	SC1 REDSKINS	080914
KW1 HORNETS	080232	SC1 DODGERS	080220	KW1 COWBOYS	080189	KW1 SAINTS	080227
KW1 KINGS	080209	KW1 PADRES	080223	SC1 COWBOYS	080190	SC1 SAINTS	080925
SC1 KINGS	080210	SC1 PADRES	080224	KW1 DOLPHINS	080254	SC1 SEAHAWKS	080915
KW1 LAKERS	080205	KW1 GIANTS	080225	SC1 DOLPHINS	080255	KW1 SEAHAWKS	080916
SC1 LAKERS	080206	SC1 GIANTS	080226	KW1 EAGLES	080085	SC1 STEELERS	080089
KW1 MAVERICKS	080201	KW1 RANGERS	080229	SC1 EAGLES	080092	KW1 STEELERS	080096
SC1 MAVERICKS	080202	SC1 RANGERS	080710	KW1 FALCONS	080256	KW1 TEXANS	080228
KW1 ROCKETS	080234	KW1 ROCKIES	080217	SC1 FALCONS	080257	SC1 TEXANS	080715
SC1 ROCKETS	080713	SC1 ROCKIES	080218	KW1 GIANTS	080086	KW1 TITANS	080270
KW1 SPURS	080235	KW1 YANKEES	080115	SC1 GIANTS	080093	SC1 TITANS	080271
SC1 SPURS	080714	SC1 YANKEES	080122	KW1 JAGUARS	080262	KW1 VIKINGS	080532
				SC1 JAGUARS	080263	SC1 VIKINGS	080533



College	EZ #	College / Nascar	EZ #
KW1 LSU	081059	KW1 TEXAS A&M	084627
SC1 LSU	081060	SC1 TEXAS A&M	084626
KW1 TEXAS	083117	KW1NASCAR BLK	082885
SC1 TEXAS	083116	KW1NASCAR WHT	082887



Bit Key Mortise Lockset

2 knobs, #20 threaded spindle, #214 lock body, 2 trim plates (#213), strike, screws and 2 keys.

Mfg # IL215 04 51 EZ # 007292

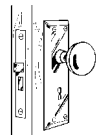



Mortise Cylinders

Mfg#	Fin.	Kwy	Size	EZ #
IL7165CA213KA2	13	Corbin 60	1"	009428
IL7165KS205KA2	5	Kwikset	1"	070443
IL7165LA 203KA2	3	Lockwood	1"	041146
IL7165NA203KA2	3	Composite	1"	009426
IL7165NA213 KA2	13	Composite	1"	029266
IL7165RA202 KA2	26D	Russwin 981	1"	029268
IL7165SX205KA2	5	Schlage C-K	1"	070447
IL7165WA205KA2	5	Weiser	1"	070449
IL7185CA103KA2	3	Corbin 60	1 1/8"	027773
IL7185GC126DKA2	26D	Sar RA-RC	1 1/8"	069869
IL7185LA126DKA2	26D	Lockwood	1 1/8"	041152
IL7185NA103KA2	3	Composite	1 1/8"	009476
IL7185NA126DKA2	26D	Composite	1 1/8"	009475
IL7185SC26 KA2	26	Schlage	1 1/8"	074610
IL7185YG103KA2	3	Yale GA	1 1/8"	071314
IL7185YG126DKA2	26D	Yale GA	1 1/8"	071313
IL7205AA103KA2	3	Arrow	1 1/4"	009454
IL7205LA126D KA2	26D	Lockwood	1 1/4"	041150
IL7205RB126DKA2	26D	Russwin D1	1 1/4"	009461
IL7205WA103KA2	3	Weiser	1 1/4"	009470
IL7205WA126DKA2	26D	Weiser	1 1/4"	009469

Key In Knob/Lever Cylinders

Mfg#	Fin.	Kwy	Size	EZ #
ILKD15395NA04	4	Composite	-	009128
ILKD15395CBKA2	26D	Corbin 67	-	041160
ILKD15395GA04KA2	4	Sargent LA	-	062034
ILKD15395YG04KA2	4	Yale GA	-	071355
ILKD15395GB04KA2	4	Sar LA-LC	-	071356
ILKD15395YG26DKA2	26D	Yale GA	-	071357
ILKD15395GB26DKA2	26D	Sar LA-LC	-	071358
ILKD15395GC26DKA2	26D	Sar RA-RC	-	071359

Rim Cylinders

Mfg#	Desc.	EZ #
IL605C04 41	Rim	040613
IL7010DC3	Dummy	061497
IL7010DC45	Dummy	060514
IL7010DC26D	Dummy	061498



Crystal Replacement Knobs

Die cast bottom, #20 spindle and set screws. 2" dia., projects 2 1/4".

Mfg # IL199 03 51 EZ # 007289



Cabinet, Desk, and Drawer Lock

Fits 7/8" dia. hole. Bolt extends 3/8" with 7/8" cylinder projection. 5 disc tumbler mechanism, furnished with 2 keys.

Mfg # IL4067 03 51KA EZ # 040619

Mfg # IL4067 03 51KD EZ # 040620



Surface Mounted Rim Locks

Night Latch (Hold Back function)

Die Cast Cylinder - 1054DL kwy

Mfg # IL220 67 41 EZ # 062870



Jimmy Proof Lock - Sgl. Cyl.

Single Cylinder - 1054DL kwy

Mfg # IL530 53 41 EZ # 040612

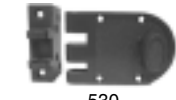

Double Cylinder - 1054DL kwy

Mfg # IL535 53 41 EZ # 062871

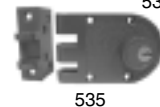

Rim Deadlock

Painted brass finish - 1054DL kwy

Mfg # IL545 53 41 EZ # 007335

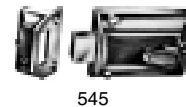

Window Lock

- Die cast construction • Bright brass finish
- 5 disc tumbler cylinder

Mfg # IL203 03 51KA DF10 EZ # 040610



Mortise Bolts

3/8" throw, turn knob one side only. Fits doors 1 1/4" to 1 7/8" thick. 2" B.S.

Mfg # IL5050 04 51 (Satin Brass) EZ # 007328



3/8" throw, operates by key outside only. Fits doors 1" to 1 1/2" thick.

Mfg # IL5051 04 51 EZ # 007329



Misc Parts

Mfg. #	Description	EZ #
IL704 04 11	Turn knob disc - sq. hub	007374
IL861E 03 10	3/32" cylinder ring -US3	025793
IL861E 28 10	3/32" cylinder ring - alum.	007433
IL861E46 10	3/32" cylinder ring - duro.	007434
IL861F 28 10	1/4" cylinder ring - alum.	007435
IL861F 46 10	1/4" cylinder ring - duro.	007436
IL861K 00 10	3/16" vinyl cylinder ring	025794
IL861Q 28 10	3/8" cylinder ring - alum.	025795
IL861Q 46 10	3/8" cylinder ring - duro.	073800
IL861U28 10	Adj. cylinder ring - alum.	040622
IL861U03 10	Adj. cylinder ring - US3	025800
IL861W03 10	3/16" cylinder guard - US3	025798
IL862A 0010	Long tail piece for rim cyl	044582
IL863A 0010	Adams Rite Cam	007194
IL863D 0010	Clover cam	026455
IL863G 00 10	Standard cam	030342
IL863E 00 10	Narrow cam	007440
IL869 00 10	Cash box cylinder nut	035643
AM CAM	2" Long straight cam	040573
IL1176RK	Titan Rekeying tool	007098
SK6750	Handcuff Key	042053



Deadlock Long Throw

- Cylinder backset available 3/32" or 1 1/8"
- Bolt 13/16" throw, made of 5 ply laminated steel w/center ply case hardened to resist hacksaw attacks.
- Lock accepts standard mortise or thumbturn cylinders w/A.R. type cam.
- 1" x 6 7/8" flat faceplate.



Mfg#	EZ #
INDT1851 31/32 AL	040792
INDT1851 31/32 DU	040794
INDT1851 1 1/8 AL	040795
INDT1851 1 1/8 DU	040812

Deadlatch Lock

- Cylinder backset available 3/32" or 1 1/8"
- 1" x 6 7/8" flat faceplate, Key controlled dogging.
- Latchbolt 1/2" throw, chrome plated with Delrin insert for smooth, quiet latching.
- Accepts standard mortise or thumbturn cylinder w/A.R. type cam.
- Field reversible for opposite hand.



Mfg#	EZ #
INDL4511 31/32 AL	040772
INDL4511 31/32 DU	040773
INDL4511 1 1/8 AL	040783
INDL4511 1 1/8 DU	040791

Paddle Handle

- For Use with DL-4511 type latch lock
- Field reversible for opposite hand, push & pull plates included
- Push or pull paddle handle
- Cam plug, field reversible, included



Mfg#	EZ #
INPH4520AL	062817
INPH4520DU	062824

Lever Handle

- For use with DL-4511 type latch lock
- Cam Plug, field reversible, included



Mfg#	EZ #
INHL4560AL	062815
INHL4560DU	062816

Flushbolt

- 1/16" x 4 1/4" Radius Face
- Positive "U" joint actuator with 3/8" throw
- 1/8" offset with 1/16" backset
- Rod length for 12" centerline of face installation



Mfg#	Desc.	EZ #
INFB1202 1200AL	Alum. flushbolt	071550
INFB1202 1200DU	Duro. flushbolt	071551

Hook Bolt Deadlock

- Bolt 13/16" throw, made of 5 ply laminated steel w/center ply case hardened to resist hacksaw attacks.
- Cylinder backset stocked 1 1/8" and 3/32"
- Lock accepts standard mortise or thumb turn cylinders w/A.R. type cam.
- 1" x 6 7/8" flat faceplate.



Mfg#	Desc	EZ #
INDH1821H118AL	Alum. deadlock	062813
INDH1821H118DU	Duro. deadlock	062814
INDH1821H31/32AL	Alum. deadlock	069718

Strike Set

- Non-handed Strike for Left or Right hand installation.
- Used when replacing a MS lock with Deadlatch Lock on offset Door and Frame.
- Dustbox and back-up plate included.



Mfg # INSC4520AL EZ # 062818

Concealed Door Closer

- Center Hung Doors: double or single acting (door stop applied to frame renders unit single acting).
- 2 speed control valves: closing & latching speeds controlled by separate regulating valves
- Positive centering for alignment and to hold door closed against any normal wind or draft
- Fits in an aluminum header or transom bar as small as 1 1/4" x 4"



Mfg#	Description	EZ #
IN230S	w/ hold open	066159
IN231S	w/o hold open	066160

Adjustable Spring Power Closers

- 2 speed control valves: closing & latching speeds controlled by separate regulating valves
- Universal application.
- Non- handed
- ADA closer with adjustable spring power for a 5 lb. opening force to a size 4



Mfg#	Desc.	EZ #
IN5003AL	w/dress cover	073384
IN5003DU	w/dress cover	073385
IN8053AL	w/adj. spring	070738
IN8053DU	w/adj. spring	070739



Offset Pivot Sets

Mfg#	Desc.	EZ #
INOP2700AL	Flush doors	083963
INOP2700DU	Flush doors	083964
INOP2800AL	1/8" recessed doors	083965
INOP2800DU	1/8" recessed doors	083966



1095 Series Rim Panic Device

Features:

- Concealed fastening
- Extra-heavy duty lever arms and bodies
- Nylon bushings at arm pins
- Contoured cross bar
- Doors requiring entrance by key use standard rim cylinder
- Dual dogging feature:
 - By key in cylinder from outside
 - By dogging pins beneath housing
- Dual operating Functions (Field Selectable):
 - Regular – key removable in unlocked position
 - Night latch – key removable in locked position only
- **Handed – not reversible**

Materials:

Body and Arm – High tensile strength aluminum
 Cross Bar – Extruded aluminum
 Internal Parts – Precision made special alloy. White bronze latch bolt with stainless steel pin

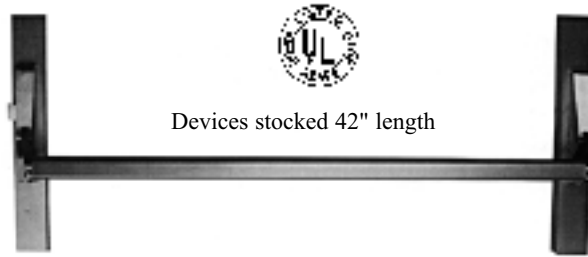

Devices stocked 42" length

Mfg#	EZ #
JS1095 313LHR 4/0 XC	028046
JS1095 313RHR 4/0 XC	028044
JS1095 628LHR 4/0 XC	043106
JS1095 628RHR42 4/0 XC	030301



Actuator Kit

Mfg # JS30 852 EZ #074519

1085 Series Concealed Vertical Rod Panic Exit Device

Suitable for narrow, medium or wide style aluminum doors or 1 3/4" hollow metal. For use in out-swinging single-acting doors, hung on butts or pivots, or center-pivoted. Should be installed when doors are being fabricated.

FEATURES:

- Concealed fastening
- Extra-heavy duty lever arms and bodies
- Wear points insulated by nylon sleeves and rollers
- Doors requiring entrance by key use cylinder pad #30-821J (Uses standard mortise cylinder with "MS" cam)
- Dual dogging feature:
 - By key in cylinder from outside
 - By dogging pins beneath housing
- Contoured cross bar
- Independent bolt action, 5/8" bolt throw
- **Non-handed**

Materials:

Body and Arm – High tensile strength aluminum
 Cross Bar – Extruded aluminum
 Internal Parts – Plated steel; stainless steel springs



Mfg#	EZ #
JS1085 313 4/0X7/0	028342
JS1085 628 4/0X7/0	028343



Cylinder Mounting Pad w/ Locking Ring

Mfg # JS30 821JXXX628

EZ # 029275



Kaba Peaks

Patented Key Control is going where it has never gone before. With the growing PEAKS® family you have an unprecedented competitive edge! Offer your customers solid patent protection with the ONLY product that permits interlinking of non-Best cores with conventional and original IC core. You can mix conventional cylinders with any style PEAKS® core in the same system. Your competition has the added cost of replacing hardware.

You and your customers win with PEAKS!

What is PEAKS?

Peaks is the most flexible, technically simple, economical, patented key control system available. Two projections near the key bow, called the “peaks” are part of the utility patents safeguarding the key blanks. The top “peak” operates the patent pin stack. The bottom “peak” travels in a groove in the shell. Both are needed. Since the key blank itself is patented, KABA can control their manufacture and distribution.

PEAKS Advantages

- Blanks and cut keys protected by strong, uncontested utility patents
- Patented key control without added expense of UL437
- Technically simple
- Uses existing key machines
- Lowest cost entry into key control market
- Combines conventional cylinders, Best, Corbin Russwin and Yale style cores in the same system
- Corbin Russwin and Yale style cores pin just like Best - No lost bittings or keying limitations
- Retrofits a wide variety of lock brands and types
- Locksmith controlled and managed - Dealers write their own key systems
- Same pins used for both ICORE and conventional cylinders
- Cylinders resistant to key manipulation for safer master keying
- Keyway families for large institutional end users
- Made in America by the world's largest manufacturer of key control and high security products
- World class factory support



Patents

The first purpose of high security locks is prevention of unauthorized key duplication. Contracts, limited distribution, key records control, and strong utility patents are essential to state-of-the-art key control. Kaba High Security Locks Corporation and Kaba Holding AG will bring any necessary legal action against any person or persons producing or contributing to the production of unauthorized PEAKS® or GEMINI® keys or key blanks. Kaba in no way condones or encourages the infringement of valid patents.

Brand	Patent	Expires
Kaba GEMINI® T	utility	April 7, 2010
Kaba PEAKS®	utility	May 21, 2008
Kaba GEMINI®	utility	April 25, 2006
Schlage Primus®	utility	July 12, 2005
Medeco® Biaxial®	utility	Jan 13, 2004
Assa Twin® on blank	design	expired 1999
Medeco® Original	utility	expired 1987

HERE ARE FIVE PRINCIPLES TO HELP DETERMINE THE STRENGTH OF A PATENT.

1. The patent must be a utility patent, NOT a design patent. Ask for the patent number and type. Utility patents have seven digits, design patents have only five.
2. The patent must cover the key blank AND the features on the key blank necessary to operate the cylinder.
3. The patented key blank must have a mechanical feature that makes it the ONLY THING that can be used to open your locks. **This is critical.**
4. The patent must be able to stand up in court. If any key can be made to operate the lock and the patent holder can not prevent it, the patent is ineffective for key control.
5. The patent should have survived several years without challenge to its validity.

R and H keyways are for contracted Locksmiths only.



Rim Cylinder

Mfg #	Description	EZ #
KA3402 11 1010R	140 Standard Rim Cylinder	062494
KA3402 25 1010R	140 Standard Rim Cylinder	062492
KA3402 25 1010D	140 Standard Rim Cylinder	007600
KA3402 25 1010H	140 Standard Rim Cylinder	061520
KA3402 03 1010H	140 Standard Rim Cylinder	066728



Key-N-Knob

Mfg #	Description	EZ #
KA3400 04 1006R	140 Cylinder Kit (Sch.,LSDA)	062487
KA3400 25 1006R	140 Cylinder Kit (Sch.,LSDA)	062486
KA3400 25 1010R	140 Sargent 10 Line	063514
KA3400 25 1065R	140 Sargent 6500 & 6Line	063516
KA3400 04 1099R	140 Peaks Universal	068955
KA3400 25 1099R	140 Peaks Universal	068954
KA3400 25 1006H	140 Cylinder Kit (Sch.,LSDA)	063872
KA3400 04 1099H	140 Peaks Universal	068956
KA3400 25 1099D	140 Peaks Universal	068176
KA3400 25 1099H	140 Peaks Universal	068177



I/C

Mfg #	Description	EZ #
KA3840 04 1006R	6-pin - Capped	062498
KA3840 25 1006R	6-pin - Capped	062497
KA6840 04 1006R	6-pin - Spring Cover	063522
KA6840 25 1006R	6-pin - Spring Cover	062499
KA3840 04 1006H	6-pin - Capped	063875
KA3840 25 1006H	6-pin - Capped	061521
KA6840 04 1006H	6-pin - Spring Cover	063877
KA6840 25 1006H	6-pin - Spring Cover	063876
KA3840 25 1006F	6-pin - Capped	069550



Mortise Cylinders

Mfg #	Description	EZ #
KA3401 03 1018R	140 1 1/8" Mortise	062490
KA3401 11 1018R	140 1 1/8" Mortise	062491
KA3401 25 1018R	140 1 1/8" Mortise	062489
KA3401 25 1014R	140 1 1/4" Mortise	062488
KA3401 03 1018H	140 1 1/8" Mortise	064319
KA3401 11 1018D	140 1 1/8" Mortise	029006
KA3401 11 1018H	140 1 1/8" Mortise	063874
KA3401 25 1018D	140 1 1/8" Mortise	007610
KA3401 25 1018H	140 1 1/8" Mortise	061519



Kaba Service Tools & Parts

Mfg #	Description	EZ #
KA3418 00 3003	Cloverleaf Cam	007607
KA3425 00 2006	Rim/Mortise Slide Cover	029843
KA3800 00 3001	Jaw for 1200CM	061281
KA3800 00 3547	Capping Tool	063659
KA3800 00 3548	Ejector Tool	063657
KA3800 00 4010	Best style spring	035939
KA3800 00 4221	I/C Caps	007644
KA3840 00 3540	140 Capping Block	063513
KA4700 80 2007	LSDA Tailpiece	063520
KA6440 00 2000	KIK Slide Cover	029844
KA6800 00 2006	I/C Spring Cover - 6 pin	063518
KA6840 00 3540	I/C Staking Block	062501

Kaba Pins

Mfg #	Description	EZ #
KA3425 00 3002	Convent Patented Top Pin	035916
KA3800 00 3004	Patented Bottom Pin	035937
KA3800 00 3005	Patented Top Pin	035938
KA3800 00 3200	OA Bottom Pin	007587
KA3800 00 3201	1A Bottom Pin	007588
KA3800 00 3202	2A Bottom Pin	007589
KA3800 00 3203	3A Bottom Pin	007590
KA3800 00 3204	4A Bottom Pin	007591
KA3800 00 3205	5A Bottom Pin	007592
KA3800 00 3206	6A Bottom Pin	007593
KA3800 00 3207	7AS Bottom Spool Pin	007594
KA3800 00 3208	8AS Bottom Spool Pin	007595
KA3800 00 3209	9AS Bottom Spool Pin	007596
KA3800 00 4202	2B Top Pin .025	007626
KA3800 00 4203	3B Top Pin .0375	007627
KA3800 00 4204	4B Top Pin .050	007628
KA3800 00 4205	5B Top Pin .0625	007629
KA3800 00 4206	6BS Top Spool Pin .075	007630
KA3800 00 4207	7B Top Pin .0875	007631
KA3800 00 4208	8BS Top Spool Pin	007632
KA3800 00 4209	9B Top Pin .1125	007633
KA3800 00 4210	10BS Top Spool Pin .110	007634
KA3800 00 4211	11B Top Pin .1375	007635
KA3800 00 4212	12B Top Pin .150	007636
KA3800 00 4213	13B Top Pin .1625	007637
KA3800 00 4214	14B Top Pin .175	007638
KA3800 00 4215	15B Top Pin .1875	007639
KA3800 00 4216	16B Top Pin .200	007640
KA3800 00 4217	17B Top Pin .2125	007641
KA3800 00 4218	18B Top Pin .225	007642
KA3800 00 4219	19B Top Pin .2375	064227
KA6140 00 3004	Patented Bottom Pin	065307
KA6140 00 3205	5J Bottom Pin	069029
KA6140 00 3206	6J Bottom Pin	069030
KA6140 00 3207	7J Bottom Pin	069031
KA6140 00 3208	8J Bottom Pin	069032
KA6140 00 3209	9J Bottom Pin	069033

Kaba Service Tools & Parts

Mfg #	Description	EZ #
KA3400 00 4000	Conventional Staking Block	035912
KA3400 00 4003	Plug Follower	029765
KA3400 00 5012	Universal A2 Pin Kit	068034
KA3418 00 3001	A/R Cam	007606
KA3418 00 3002	Standard Cam	007608
KA3418 00 3004	Sargent/Yale Cam	029321
KA6440 00 4001	Staking Tool	062500



Pedestrian Door Lock

X09

Approved by the GSA for use on approved Class 5 and Class 6 Filing Cabinets and Class 5 and Class 8 Security Vault Doors. The X-09 is self-powered using PowerStar technology. A twist of the dial provides all the power necessary to enter the combination, as well as review audit features.

Mfg # MIX09 EZ # 077498 Non Drill Resistant Plate: Mfg # MI11204 EZ # 077859

Combination Door Unit (CD Unit): Mfg # MICDX09 EZ # 077499 (advise strike desired)



LC Series

LC Series PowerSaver™ managed locks take a battery for all it's worth... and then some. Comes with an exclusive spindleless slide bolt and features multiple user capability. LCMX has metal housing and is a breeze to install, program and operate. 1 or 2 users, 6 digit code to reset lock, 3 minute penalty after 5 wrong combinations tried.

Mfg # MILCMXCR BNN70LA4D0 EZ # 079407 (Metal Housing)

Lexan Housing: Mfg # MILCLX LXBN70LA3DO EZ # 079406 Mfg # MILCLX LXBN72LC1DO EZ # 077395 (Black Label)



52 Auditcon Lock

For small businesses and individuals. Mechanical locks take about 35 to 40 seconds to open - if you get it right the first time. Can be opened with 6-digit combination in about 7 seconds. 2 users, 3 minute penalty after 5 wrong combinations tried.

Mfg. #	Description	EZ #
MI0052RSNNN10B610	Round with deadbolt	067659
MI0052VSNNN10B610	Vertical with deadbolt	067660
MI0052VSNNB70MC10	Vertical with slidebolt	078384
MIOT52VSNNB70MC10	Vertical with slidebolt, time delay	080751
MIOT52VSNNN10B610	Vertical with deadbolt, time delay	080752

100 Auditcon Lock

- Up to 5 users • 8 Digit Access • No batteries or wiring • Programmable 5 -99 minutes time delay
- Provides complete listing of the user's ID, plus the type of entry/activity for up 8 events, in sequential order.

Mfg. #	Description	EZ #
MI1100R	Round	066796
MI1100V	Vertical	067486
MI0100RSNN10B610	Round with deadbolt	079408
MI0100RSNNB70MC10	Round with slidebolt	078305
MI1100VSNN10B110	Vertical with deadbolt	079409
MI0100VSNNB70MC10	Vertical with slidebolt	078306



400 Auditcon Lock

- Up to 99 users • 8 Digit Access • No batteries or wiring • Programmable 5 -99 minutes time delay
- Audit Trail: Number of entries/activities is increased to 200 records and stamps the date and time of entry. In addition, the lock records up to 10 different types of events/activities..

Mfg. #	Description	EZ #
MI0400VSNNN10B110	Vertical with deadbolt	079469
MI0400VSNNB70MC10	Vertical with slidebolt	078308



500 Auditcon Lock

- Up to 99 users • 8 Digit Access • No batteries or wiring • Programmable 5 -99 minutes time delay
- Audit Trail: Number of entries/activities is increased to 400 records and stamps the date and time of entry. In addition, the lock records up to 10 different types of events/activities..

Mfg. #	Description	EZ #
MI0500VSNNN10B110	Vertical with deadbolt	078309
MI0500VSNNB70MC10	Vertical with slidebolt	078310



2100 Auditcon Lock

- Up to 60 users. • 8 Digit Access • Programmable 5 - 99 minutes time delay
- Combining Personal Identifier "Smart Keys" with PIN (Four Digit Code) provides one of the highest levels of security available today, requiring the potential thief to possess both the key and the PIN to gain access.
- Audit Trail: Number of entries/activities is increased to 888 records and stamps the date and time of entry. In addition, the lock records up to 10 different types of events/activities. The audit trail provides a complete listing of the lock's activities, including the identity of the user, date and time of entry, plus the type of entry/activity.



Mfg # MI21000D20DB0 EZ # 079470

Software: Mfg # MI211108 EZ # 078311 Implementation package: Mfg # MI211100 IMP PKG EZ # 062523

2000 Cencom ATM Locking System

- Complete Access Control - user needs a One Time Combination (OTC) and "SmartKey" in order to access the lock.
- Records all lock activity up to 956 events and permits easy downloading via a "SmartKey" for generating detailed audit reports.
- Completely stand-alone and self powered

Mfg. #	Description	EZ #
MI201236US	Alarm shunt, 55mm thick door	077860
MI201237US	W/O alarm shunt, 55mm thick door	077967
MI201250US	Alarm shunt, 113mm thick door	077861
MI201301US	W/O alarm shunt, 44.3mm thick door	077862



Smart Keys

Mfg. #	Description	EZ #
MI202020	Key F (blue)	077854
MI202022	Key R (yellow)	077855
MI202023	Key B (green)	077856
MI202024	Key D (black)	077857
MI202025	Key S (black)	077858
MI202030	Key A (orange)	067489

Accessories

Mfg. #	Description	EZ #	Mfg. #	Description	EZ #
MI114005	#3 strike	080323	MI260775 26D 91	1/2" satin chrome handle	077864
MI114006	#9 strike	080324	MI211103	Audit software 3100	077968
MI114014	Drill resist mount plate	066119	MI511037	Kaba exit device GSA	077500
MI114024	Non-Drill resist mount plate	066120	MI307025	Remote time delay kit	078312
MI260775 63 91	1/2" black safe handle	077863	MI301040	Duress alarm inter. kit	079471



67 Series Group 2 Combination Safe Locks

- UL Group 2 rated • 3 Wheels offer up to one million possible combinations. • Locks feature conventional metal wheels.
- Supplied with a 4-Way Drive Cam for mounting versatility.
- Combination is changed using the change key supplied.
- All models feature the "relock trigger" which automatically deadlocks the bolt.

Mfg. #	Description	EZ #
IL673P71 98 41	Complete Lock, Spy-Proof, Satin Chrome	040627
IL673F21 98 41	Complete Lock, Black/White	029677
IL673000 60 41	Lock Only, 3 Wheel, Non-Tube	029678



Safe Deposit Locks

Mfg. #	Description	EZ #
40 SERIES DOUBLE NOSE, NON-CHANGEABLE		
IL400100 04 41RH	Right Hand Safe Deposit Lock	029685
IL400100 04 41LH	Left Hand Safe Deposit Lock	029686
SG4	Prep Key #4 (Guard Key)	013200
54 SERIES DOUBLE NOSE, NON-HANDED, CHANGEABLE		
IL540100 04 41	Safe Deposit Lock	029692
MI544100 04 41	Safe deposit lock	077865
MI540200 04 41BC	Safe deposit dbl change	077866
IL54 018	Change Tool	029696

Mfg. #	Description	EZ #
57 SERIES RETROFIT FOR MOSLER 5700		
IL570100 04 41	Safe Deposit Lock	029697





Locksmith Tools

Safe Change Key Sets

Case engraved with description of uses. Keys made of stainless steel.

- #1 Mosler 35-4 wheel
- #2 Mosler 302-3 wheel
- #3 S & G Amsec 3 wheel #8 S & G 4163
- #4 S & G 6720-3 wheel #9 LaGard 1R-3 wheel
- #5 Diebold 180-3 wheel #10 LaGard 3 wheel
- #6 Diebold 177-4 wheel #11 LaGard 4 wheel
- #7 S & G padlock 3 wheel #12 LG/Amsec 3 wheel



Mfg# KXX 18 EZ# 008214

Carbide Tipped Drill Bits

Specially sharpened on a diamond wheel. Made in U.S.A.

Mfg #	Size	EZ #
KX14 4	1/4" x 4"	008220
KX14 6	1/4" x 6"	008221
KX516 4	5/16" x 4"	029030
KX516 6	5/16" x 6"	029031
KX38 4	3/8" x 4"	008222
KX38 6	3/8" x 6"	008223

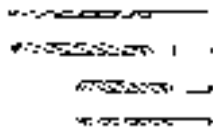

Replacement Tapered Pin

KXX16TP03	1/4"	077901
KXX16TP04	5/16"	077902

Safebuster

This tool is used to drill through hardplate. You can apply over 500 lbs. of pressure at the drill tip with about 35 lbs. of pressure at the handle. Penetrates most hardplate in minutes instead of hours.



Mfg# KXX 14 EZ# 008212

- Can be used with many makes and models of drill motors
- Precision made from quality material
- Large, comfortable handle grip
- Minimum time for setup & take down
- 12" chain included
- Quick release pins
- Drills at almost any angle
- 35 lbs. pressure on handle exerts 500 lbs. on drill tip
- Portable and built to last a lifetime
- Designed to prevent dangerous rotation of drill motor

Safe Repair Kit

Developed specifically for locksmiths, these steel taper pins and corresponding ball bearings will prove invaluable when repairing safes that have been drilled open. Five sizes of taper pins milled from bar steel to help you repair drill holes from 1/8" to 1/2". Four sizes of corresponding ball bearings to complete a professional repair.



Mfg# KXX 16 EZ# 008213

Roll Pin Kit

Contains an assortment of the zinc plated roll pins most commonly used by locksmiths. Includes sizes 1/16" thru 5/32" in diameter and 3/8" thru 1 1/2" in length. 18 different sizes. 480 pins total. All packed in a durable, 18 compartment plastic box.



Mfg# KXXRP EZ# 040859

"Spinout" Screwdriver

Prevents injuries to your hands, caused by a screwdriver slipping. Prevents stripped-out screw heads. Allows you to remove even the most stubborn screws. Includes stand, with bronze bearing, to prevent the screwdriver from slipping.



Mfg# KXSPIN EZ# 060289

K-19 Profile Cylinder Follower

A simple but effective solution to the frustration of servicing profile cylinders. Special magnetic design for easy operation



Mfg# KXX19 EZ# 040862

Straight Shot Clip Removal Tool

"The ultimate Corvette Tool." Use where you have a "straight shot" at the clip. Approx. 18". Special feature ball bearing holds clip in tool until YOU want it removed.



Mfg# KXX3 EZ# 040860

Tamper Resistant Screwdriver

Screwdriver with eleven interchangeable tips. All tips fit into screwdriver's storage handle. Invaluable for automotive work, lock work, access control and more!

- 6 tamper resistant torx tips: T10, T15, T20, T25, T27 & T30
- 3 tamper resistant hex tips: 5/32", 3/16" & 7/32"
- 2 spanner tips: #6 & #8



Mfg# KXTAMPER EZ# 065067

K2 JAWS II-L Clip Removal Tool

Ball bearing holds clip in tool until YOU want it removed. Design allows it to bump up against the lock to help take off clips that are hard to remove.



Mfg# KXX2 EZ# 026671



AUTOMOTIVE PRODUCTS

K-4 GM Decoder

Decodes all tumblers in one step without complete disassembly of the lock. Pick sidebar down. Press the K4 firmly into the 6 chambers of the lock. Read cuts with gauge provided.

Mfg# KXX4 EZ# 026672



K-8 Impressioning Plate

The plate works with your vise to hold Chrysler, Ford, AMC, Toyota, Datsun & all standard cam locks. Made of stainless steel.

Mfg# KXX8 EZ# 008218

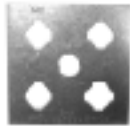

K10 G.M. Compressor

This pocket size tool compresses the lock plate spring on AMC, Chrysler tilt, G.M. tilt, telescopic, metric and standard steering columns.

Mfg# KXX10 EZ# 040861



K-VATS Interrogator

The micro VATS lets you interrogate the system without disconnecting any wires. No special adapters are needed.

Mfg# KXXVATS EZ# 008219

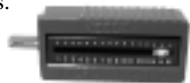

DOOR HARDWARE

K-12 Protect-A-Lock

Designed to protect locks from impact damage. Made from UL approved Lexan plastic, is virtually indestructible by impact. Installs in minutes. Guaranteed for five years.

Mfg #	EZ #
KXX12	008210
KXX12D	008211

KXX12(Cream) - KXX12D(Duranodic)



Armored Door Loops

Use when you need to transfer electrical current from the door frame to the door. 18" Flexible armored conduit. Entire assembly has an attractive and durable powder coat finish. Pre-drilled hole in base.

Mfg #	Fin.	EZ #
KXXDLB	Duro	040857
KXXDLA	Alum	040858



DOOR HARDWARE

K-24 Cylinder Guards

Free-spinning, hardened steel, tapered and cone-shaped.

Mfg #	EZ #	
KXX24A	025686	Standard
KXX24B	025687	

for 1 1/8" cylinders - 6 per pack

KXX24A626	008215	Large
KXX24B613	008216	

for 1 1/4" and 1 3/8" cylinders - sold each

A(Aluminum) -B(Duranodic)



TOOLS

K-5 Speedo II Motor

3800 RPM high torque reversible 12 volt motor. Energy efficient permanent magnet design. Motor is capable of developing a full 1/4 HP. Bronze bearings. Comes with pulley, mounting bracket and belt. One year warranty.

Mfg# KXX5 EZ# 026673



K-6 Master Follower

Made of SOLID BRASS. It can be used as a regular follower or master pin remover and follower on Schlage, Sargent, Kwikset, Weiser, Almont padlocks and many others. Special taper allows smooth operation and better control over sticking pins. .495 dia. x 4 1/2" length.

Mfg# KXX6 EZ# 029042



K-22 Lever Opening Tool

If you can slide this tool under the door, YOU WILL OPEN IT.

Mfg# KXX22 EZ# 028239

Replacement Cable
Mfg # KXX22CABLE EZ # 078380

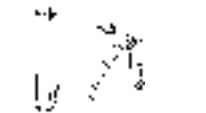

K-23 Scope

Transforms your mini flashlight into a powerful inspection device. Works with many "AA" flashlights. Consists of a 1" diameter polypropylene cap and two interchangeable fiber optic rods.

Mfg# KXX23 EZ# 028240





Aluminum Door Security

WELDABLE GATE BOXES

Single Lock Box

2 3/8" backset, 2 1/8" cross bore,
3 1/2" x 4 1/2" x 1 1/2"

Mfg #	EZ #
KXX BXSGL	068179

Single Lock Box (2 3/4)

2 3/4" backset, 2 1/8" cross bore,
3 1/2" x 4 3/4" x 1 1/2"

Mfg #	EZ #
KXX BXSGL234	035848

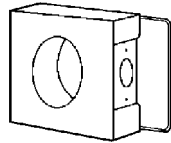

Single Slim Lock Box

2 3/8" backset, 2 1/8" cross bore,
3 1/2" x 4 1/4" x 1 1/4"

Mfg #	EZ #
KX SGL S	040855

Single Extra Slim Lock Box

2 3/8" backset, 2 1/8" cross bore,
3 1/2" x 4 1/2" x 1"

Mfg #	EZ #
KX SGL ES	040856

Single Lever Lock Box

For Schlage Rhodes levers,
4 1/8" x 4 3/4" x 1 5/8"

Mfg #	EZ #
KXX BXRHO	083372

Double Slim Lock Box

2 3/8" backset, 2 1/8" cross bore,
6 3/4" x 4 1/4" x 1 1/4"

Mfg #	EZ #
KXXBX DBL S	040853

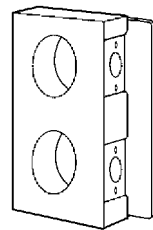

Double Extra Slim Lock Box

2 3/8" backset, 2 1/8" cross bore,
7 1/2" x 4 1/2" x 1"

Mfg #	EZ #
KXXBX DBL ES	040854

K-BXA/R Box for Adams/Rite

For 1850A, 1850S, 4710 and 4711
7" x 1 5/16" x 1 3/4"
1 1/8" backset

Mfg #	EZ #
KXX BXA/R	029033

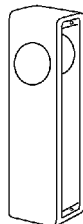

Weldable Gate Boxes

Mfg #	Size	EZ #
IP20	1" x 4" x 4 3/4"	040771
IP1 1/4	1 3/4" x 4 3/4" x 7 5/8"	040770

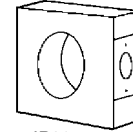

IP20

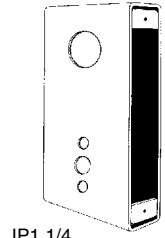

IP1 1/4

Lock Box For Simplex 1000 Series

9 1/4" x 5 1/2" x 1 3/4"

Mfg #	EZ #
KXXKBXSIM	065420

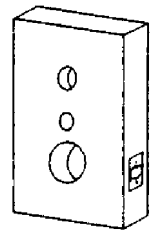

Mortise Lock Box For T22AC3

7 27/32" x 5" x 1 1/4"

Mfg #	EZ #
KXX BXMOR6	084625

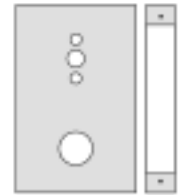

ALUMINUM DOOR SECURITY

K-15 Double Door Style Guard

12 gauge steel increases security and can repair doors that have already been attacked. Designed with knockout feature to make a W & F cutout accept an Adams Rite lock.

Mfg #	EZ #
KXXK15A	029038
KXXK15B	029039

A = Aluminum

B = Duro

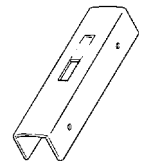

K-BXES2 Electric Strike Box

Use for installing Rofu 1402, 1702 and 3402 strikes. Also used with the Rutherford 7 Series and the Adams Rite 7100 Series.

5 1/16" x 2 3/8" x 1 3/4"

Mfg #	EZ #
KXXBX ES2	029036

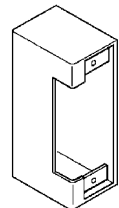

“Tiger” System

The PXL-500 Tiger Controller has all of the functionality needed to manage a single door, alarm output, and 2 reader ports. Easy-to-use “Doors” software runs on Windows 95, 98, ME, NT 4.0, 2000, and XP. The system is strong enough to manage a 256 door network at a single site or 256 doors per site at multiple sites, yet tame enough to handle a single door. The system can handle 65,000 users. The locking metal enclosure can also house KPS-4 Power Supply and battery.

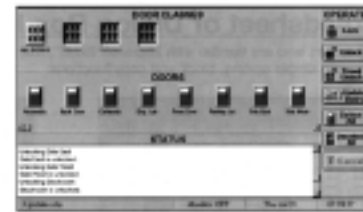
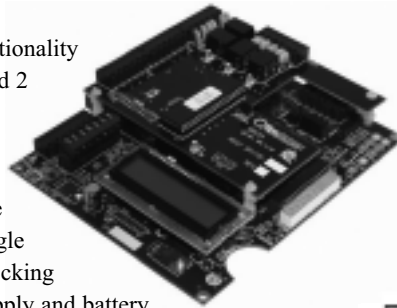

- Added RAM for increased cardholder capacity (up to 65K per controller)
- Alarm integration capability with GE Interlogix/Caddx NX-8E Alarm Panel
- On-board LAN socket for new low cost LAN-500
- Increased EEPROM memory to support future enhanced firmware capabilities

The SB-293 satellite expansion board gives each PXL-250 an additional 8 general purpose inputs and 4 general purpose outputs.

User Name	User ID	Access Date	Access Time	Door	Status
John Doe	1001	10/10/2000	08:00	101	Success
Jane Smith	1002	10/10/2000	08:05	101	Success
Bob Johnson	1003	10/10/2000	08:10	101	Success
Alice Brown	1004	10/10/2000	08:15	101	Success
Charlie White	1005	10/10/2000	08:20	101	Success
Diana Green	1006	10/10/2000	08:25	101	Success
Frank Black	1007	10/10/2000	08:30	101	Success
Grace King	1008	10/10/2000	08:35	101	Success
Henry Lee	1009	10/10/2000	08:40	101	Success
Ivy Scott	1010	10/10/2000	08:45	101	Success

Mfg #	Desc	EZ #
KIDOORS	Doors software	068435
KIPXL500P	Tiger controller II	080403
KIPXL250W	Tiger controller for Weigand	070288
KISB293	Expansion board for Tiger	068433

MS Series Readers

MicroStar Mullion-Mount Reader

- Only 3.4” x 1.4” x .38”
- Up to 4” (10 cm) read range

Mfg# KIMS3000 EZ# 068438



KIMS3000

MiniStar Standard Reader

- Only 4.3” x 3” x .38”
- Up to 8” (20 cm) read range

Mfg# KIMS5000B EZ# 068439



KIMS5000B

KIMS7000B (15” range) and KIMS9000 (24” range) readers may also be special ordered.

IntelliProx Series Reader

MicroStar Mullion-Mount Reader

- Only 3.3” x 1.4” x .38”
- Up to 4” (10cm) read range

Mfg # KIIP2003X mullion prox reader EZ # 068427



KIIP2003

MiniStar Standard Reader

- Only 4.2” x 3.0” x .38”
- Up to 8” (20cm) read range

Mfg # KIIP2005BX sgl gang prox reader EZ # 068428

Mfg # KIP500 26 bit prox reader EZ # 069815



KIIP2005 (black only)

D-lite software (FREE with purchase) features:

- Computerized cardholder database that is sortable (like Excel spreadsheet).
- The ability to backup the database
- Manage more than one IP-2000 database from the same PC

Card Options

Standard Proximity Card

Mfg# KIKC10X EZ# 069859



26 Bit Prox Cards

Mfg# KIKC26X EZ# 068436



Proximity Key Ring Tag

Mfg# KIPKT10X EZ# 069814

Accessories

Mfg #	Desc	EZ #
KIHPP22	Hand held programmer For IntelliProx 2000	068430
KIKDP251	Cable (PXL-250 / PC - 25 Pin)	069818
KIKDP252	Cable (PXL-250 / PC - 9 Pin)	069819
KIKPS5	Power Supply (12VDC 2A w/charger circuit)	069744
KILCD1	Alpha/Numeric plug in display for PXL 250	068434
KISM2000X	Smart Module for Intelliprox	068431



Chain & Padlock

Chain is triple heat-treated Boron Manganese steel with a unique trapezoidal shaped link that resists attacks from bolt cutters, saws, hammers and chisels. 5' 6" chain.

Mfg # KV810209 EZ # 077106



Heavy Duty Locking Cable

Braided steel vinyl coated cable for serious, but flexible security. Integrated 7-pin pick and drill resistant tubular locking mechanism. 3/8" diameter and 6' length.

Mfg # KV820703 EZ # 077107



Key Cable

Flexible vinyl coated steel cable with a tough integrated key lock. Weather resistant cylinder. Two coded keys. 5' x 1/2" diameter cable.

Mfg # KV830139 EZ # 076971



Flexible Steel Cable

Braided steel vinyl coated cable in 3/8" diameter with extra long oversized swages. Double loop design allows cinching for more usable length and more flexible use with virtually any padlock.

Mfg #	Size	EZ #
KV830504	30' x 3/8" dia.	077108
KV830412	15' x 3/8" dia.	076974



Resettable Combination Cable

Flexible 3/8" diameter, 5' vinyl coated steel cable with a tough integrated 4-digit resettable combination lock. Combination can be set and reset quickly & easily.

Mfg # KV830207 EZ # 076972



Extra Large Padlock

Extra large case hardened steel shackle. 7-pin pick and drill resistant tubular cylinder. Inner dimensions of shackle are 11" x 4". 1/2" shackle diameter.

Mfg # KV830603 EZ # 077103



PL Series Padlock

Design for high risk locations. Solid brass body and hardened solid steel shackle. Includes a rekeyable Schlage 6-pin cylinder.

Mfg # SCPL1001 EZ # 012628



In Ground Security Anchor

An extra-tough theft resistant locking point, for use indoors and out, providing protection from ride-away, roll-away and lift-away theft. 3/8" hardened carbon alloy steel shackle lays flat when not in use. Weatherproof, impact resistant body. Reinforced steel anchor bars which can be buried up to 10" depth. Recommended for both commercial and residential installation.

Mfg # KV330202 EZ # 077105



Heavy Duty Solid Steel Padlock

Hardened solid steel with Molybdenum steel shackle for greater resistance to sawing, cutting and prying attacks Double deadbolt locking mechanism. Quick change shackle design. 6-pin brass cylinder is rekeyable and changeable. Accepts Lori, Medeco, Schlage and American Lock cylinder. Keyed alike. 6 per box. 2 1/2" / 63.5mm body, 2" / 50mm shackle length, 3/16" / 11mm shackle diameter

Mfg # KV851226 EZ # 076979



Covered Laminated Steel Padlock

Case hardened steel shackle. Double deadbolt locking. Plated, laminated steel body, covered cylinder for increased weather protection.

1 1/2" / 70mm body, shackle: 1 1/8" clear, 1/4" dia. Mfg # KV850410 EZ # 077102



Solid Steel Shrouded Padlock

Shrouded Molybdenum steel shackle for maximum resistance to sawing, cutting and prying attacks. Double deadbolt locking mechanism. Quick change shackle design. 6-pin brass cylinder is rekeyable and changeable. Accepts Lori, Medeco, Schlage and American Lock cylinder. Keyed alike. 6 per box.

2" / 50mm body, 1 1/8" / 27.8mm shackle length, 3/8" / 9mm shackle diameter

Mfg # KV851189 EZ # 077104



Display Kits

Floor Stand: 330202 (1), 810209 (1), 820703 (2), 830504 (2), 851226 (2), 830207 (2), 830139 (2), 850410 (2)

Mfg # KV410164 EZ # 077057

Counter Top: 830412 (2), 830603 (2), 830139 (2), 830207 (2), 851226 (2), 851189 (2)

Mfg # KV410171 EZ # 077058





IC Cores • Mortise Cylinder Housings

Rim Cylinder Housings

Uncombined Cores Six Pin

Mfg #	Kwy	Fin	EZ #
KS206A4	A	US4	007674
KS206A26D	A	26D	007673
KS206B26D	B	26D	007675
KS206C26D	C	26D	007677
KS206D26D	D	26D	007679
KS206E4	E	US4	007682
KS206E26D	E	26D	007681
KS206F26D	F	26D	007683
KS206G26D	G	26D	007685
KS206H26D	H	26D	007687
KS206J26D	J	26D	007689
KS206K26D	K	26D	040863
KS206KMT300 26D	KMT	26D	028205
KS206L26D	L	26D	007691
KS206LSX26D	LSX	26D	060250
KS206LSX4	LSX	US4	060249
KS206M26D	M	26D	069002

Uncombined Cores Seven Pin

Mfg #	Keyway	Finish	EZ #
KS207A26D	A	26D	007693
KS207B26D	B	26D	007695
KS207C26D	C	26D	007697
KS207D26D	D	26D	007699
KS207E26D	E	26D	007701
KS207F26D	F	26D	007703
KS207H26D	H	26D	007707
KS207J26D	J	26D	007709
KS207K26D	K	26D	030425
KS207L26D	L	26D	007711
KS207M26D	M	26D	072651



Combined Cores

Six Pin Keyed Cores

Mfg#	EZ #
KS206A26D KA2	035855

Control Key for Above

Mfg#	EZ #
KSCONKEY743652	040866

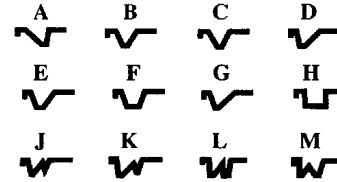

Mortise Cylinder Housings (less core)

Mfg #	Finish	Cam	EZ #
1 1/4" - 6 Pin			
KS306 STD 3	US3	Std	028198
KS306 10B	10B	Std	007713
KS306AR10B	10B	A/R	040864
KS306AR26D	26D	A/R	040865
* KS406 10B	10B	N/A	073554
* KS406 26D	26D	N/A	073500
1 3/8" - 6 and 7 Pin			
KS307AR 26D	26D	A/R	028210
KS307STD10B	10B	STD	068980
KS307STD 26D	26D	STD	007717
KS307CLV 26D	26D	Clover	028211
* KS407 26D	26D	N/A	073501
* KS407 613	613	N/A	073964
1 1/4" - 6 Pin - Tapered Head			
KS316 AR 10B	10B	A/R	007725
KS316 AR 26D	26D	A/R	007726
* KS416 10B	10B	N/A	074922
* KS416 26D	26D	N/A	073557
1 3/8" - 6 and 7 Pin - Tapered Head			
* KS417 26D	26D	N/A	073502
* KS417 613	613	N/A	073965
Rim Cylinder Housings 6 and 7 Pin (less core)			
KS308 3	3		028212
KS308 10B	10B		007719
KS308 26D	26D		007720

* sold less cam, with cam screws & retainer



No. 308
Rim Cylinder

No. 306, 307
Mortise Cylinder



No. 316
Tapered Mortise Cylinder

Accessories

Mfg #	Desc.	EZ #
KS700	Standard cam	073503
KS701	Adams Rite cam	073504
KS702	Clover cam	073505
KS702-L	Schlage cam	073506
KS702-S	Sargent cam	073558
KS400	Cam retainer	073507
KS400K KMT	Keyblank for KMT kwy	063448
KS400K LSX	Keyblank for LSX kwy	060253
KS405	Cam screw (1) *	073508

* 2 screws per housing is required

Finishes

03 = Bright Brass	10B = Oil Rubbed Bronze	04 = Satin Brass
26 = Bright Chrome	10 = Satin Bronze	26D = Satin Chrome
613 = Oil Rubbed Bronze		



Residential Grade 3

Mfg. #	Fin.	EZ #
<i>200 Passage Set</i>		
KW200B3	3	043076
KW200B3 RCL RCS	3	067121
KW200T3	3	026680
KW200T3 RCL2993 RCS	3	061407
KW200T3CP RCL2993RCS	3	067119
KW200T5	5	043077
KW200T5 RCL2993 RCS	5	040880
KW200T26D	26D	040881
KW200T26D RCL2993 RCS	26D	067118
KW200P3	3	026679
KW200P3 RCL2993 RCS	3	064133
KW200P5 RCL2993 RCS	5	040877
KW200P15A RCL RCS	15A	074644
KW200P26D RCL&S	26D	072247
<i>300 Privacy Set</i>		
KW300B3 RCL RCS	3	067126
KW300T3	3	026693
KW300T3 2993RCL RCS	3	061408
KW300T5	5	043141
KW300T5 RCL 2993 RCS	5	040904
KW300T26D	26D	040905
KW300P3	3	026691
KW300P3RCL RCS2993	3	064134
KW300P5RCL 2993 RCS	5	068316
KW300P15A RCL RCS	15A	074645
KW300P26D RCL&S	26D	072247
<i>400 Entrance Lockset – Locked by inside turn button or outside by key.</i>		
KW400B3K3	3	043078
KW400B3KD23/4W5KEY	3	078059
KW400B5K3	5	043113
KW400T3K3	3	026705
KW400T3CP RCL RCS K3	3	067108
KW400T3KD MK12112	3	026707
KW400T3RCL RCS K3	3	067111
KW400T3KD RCL RCS	3	061406
KW400T5K3	5	026708
KW400T5RCL RCS K3	5	067113
KW400T26D K3	26D	040926
KW400T26D KD MK12112	26D	079344
KW400T26D RCL RCS K3	26D	067107
KW400T26D RFDL2996 K3	26D	073410
KW400T26D PK67767	26D	040933
KW400P3K3	3	026702
KW400P3RCL RCS K3	3	064135
KW400P5K3	5	040916
KW400P5RCL RCS	5	064136
KW400P5RCL RCS K3	5	067097
KW400P15A RCL RCS KA3	15A	074646
KW400P26D RCL&S	26D	072292



Bel Air (B)



Polo (P)



Tylo (T)

Stocked with 2 3/8" Backset

RCL - Radius Corner Latch

RCS - Radius Corner Strike

RFDL - Round face drive in latch

CP - Clear Pack **MK** - Master Keyed

PK - Protecto Keyed

3 - Bright Brass

5 -Antique Brass

26D - Satin Chrome

15A - Satin Nickel Plated

Mfg. #	Fin.	EZ #
--------	------	------

488 Dummy Knob

KW488T3	3	063243
KW488T5	5	040957
KW488P3	3	064132
KW488P5	5	040956



UltraMax Grade 2 Locksets

UltraMax Grade 2 Locksets

Mfg. #	Fin.	Backset	EZ #
Passage Set			
KW720A 3	3	2 3/8"	050293
KW720A 5	5	2 3/8"	044968
KW720A CP3	3	2 3/8"	070228
KW720CA3	3	2 3/8"	026676
KW720CA5	5	2 3/8"	064144
KW720CA15A RCL&S	15A	2 3/8"	076722
KW720CA CP3	3	2 3/8"	070231
KW720CA CP5	5	2 3/8"	070234
KW720CZ3	3	2 3/8"	064154
KW720CZ5	5	2 3/8"	064155
KW720H3	3	2 3/8"	029720
KW720H15A RCL&S	15A	2 3/8"	076726
KW720R5	5	2 3/8"	026678
KW720R CP5	5	2 3/8"	070220
Privacy Set			
KW730A3	3	2 3/8"	050291
KW730A5	5	2 3/8"	044972
KW730A CP3	3	2 3/8"	070225
KW730A CP5	5	2 3/8"	070222
KW730CA3	3	2 3/8"	026687
KW730CA15A RCL&S	15A	2 3/8"	076723
KW730CA CP3	3	2 3/8"	070230
KW730CA CP5	5	2 3/8"	070233
KW730CZ5	5	2 3/8"	064157
KW730H3	3	2 3/8"	029721
KW730H5	5	2 3/8"	064149
KW730H15A RCL&S	15A	2 3/8"	076727
KW730R5	5	2 3/8"	026688
KW730R CP5	5	2 3/8"	070219
Entrance Lockset – Locked by inside turn button or outside by key. Stocked KA3.			
KW740A3KD	3	2 3/8"	043114
KW740A5	5	2 3/8"	050029
KW740A CP3	3	2 3/8"	070224
KW740CA3	3	2 3/8"	029715
KW740CA5	5	2 3/8"	064146
KW740CA15A RCL&S	15A	2 3/8"	076724
KW740CA CP3	3	2 3/8"	070229
KW740CA CP5	5	2 3/8"	070232
KW740CZ3	3	2 3/8"	064158
KW740CZ5	5	2 3/8"	064159
KW740H3K3	3	2 3/8"	040980
KW740H LO3	3	2 3/8"	072279
KW740H5	5	2 3/8"	064150
KW740H15A RCL&S	15A	2 3/8"	076728
KW740H26D	26D	2 3/8"	044977
KW740R5K3	5	2 3/8"	026700
KW740R CP5	5	2 3/8"	070218



- CP - Clear Pack
- 3 - Bright Brass
- 5 - Antique Brass
- 15A - Satin Nickel Plated
- 26D - Satin Chrome
- LO - Lifetime Finish Warranty

Full 50 year warranty against mechanical failure.

Stocked With 2 3/8" Backset



Hampshire (HL)



Republic (RL)



Roman (R)



Circa (CA)



Abbey (A)



Cortez (CZ)



Hancock (H)

Mfg. #	Fin.	EZ #
Double Cylinder Knobs		
KW701H3	3	075959
KW701H5	5	075960
Dummy Knobs		
KW788CA3	3	064160
KW788CA15A RLC&S	15A	076725
KW788H 3	3	040986
KW788H15A RCL&S	15A	076729



Knobs, Levers & Handlesets

Society Brass Collection

Mfg. #	Fin.	EZ #
<i>Passage Knobs</i>		
KW790W15A RCL&S	15A	076708
KW790W LO3RCL&S	3	076704
<i>Privacy Knobs</i>		
KW724W15A RCL&S	15A	076707
KW724W LO3RCL&S	3	076703
<i>Entrance Knobs</i>		
KW743W15A RCL&S	15A	076706
KW743W LO3RCL&S	3	076702
<i>Dummy Knobs</i>		
KW742W15A	15A	076709
KW742W LO3	3	076705
<i>Passage Levers</i>		
KW790PML LO3RCL&S	3	076693
KW790PML 15A RCL&S	15A	076699
<i>Privacy Levers</i>		
KW724PML LO3RCL&S	3	076692
KW724PML 15A RCL&S	15A	076698
<i>Entrance Levers</i>		
KW743PML LO3LH RCL&S	3	076689
KW743PML LO3RH RCL&S	3	076690
KW743PML15A LH RCL&S	15A	076696
KW743PML15A RH RCL&S	15A	076697
<i>Dummy Levers</i>		
KW742PML L03LH	3	076694
KW742PML L03RH	3	076695
KW742PML 15A LH	15A	076700
KW742PML 15A RH	15A	076701
<i>Single Cylinder Handlesets (less trim pack)</i>		
KW884LIP LO3RCAL&S	3	076685
KW884LIP15A RCAL&S	15A	076686
KW878LIP LO3RCAL&S	3	076687
KW878LIP15A RCAL&S	15A	076688
<i>Single Cylinder Trim Pack</i>		
KW562PML LO3LH RCL&S	3	076712
KW562PML LO3RH RCL&S	3	076713
KW562PML15A LH RCL&S	15A	076714
KW562PML15A RH RCL&S	15A	076715
KW562W LO3RCL&S	3	076710
KW562W15A RCL&S	15A	076711
<i>Double Cylinder Trim Pack</i>		
KW563PML LO3LH RCL&S	3	076718
KW563PML LO3RH RCL&S	3	076719
KW563PML15A LH RCL&S	15A	076720
KW563PML15A RH RCL&S	15A	076721
KW563W LO3RCL&S	3	076716
KW563W15A RCL&S	15A	076717



- Solid forged-brass
- Achieves ANSI A156.5 Grade 2 Security Rating
- LO** - Lifetime Finish Warranty

Stocked With 2 3/8" Backset



Windham(W)



Pembroke (PML)



Amherst (878)



Shelburne (884)

Standard Duty Lever Locksets

Mfg. # Fin. EZ #

Passage Set – Stocked 2 3/8" backset.

KW200DL3	3	028956
KW200DL3 RCL RCS	3	067123
KW200DL5RCL RCS	5	040871
KW200DL26D	26D	040872
KW200DL26DRCL RCS	26D	067122
KW200DNL3	3	062468
KW200DNL3RCL RCS	3	067124
KW200DNL5RCL RCS	5	040873
KW200LL3LH	3	007885
KW200LL3LH RCL RCS	3	067114
KW200LL3RH	3	007886
KW200LL3RH RCL RCS	3	067115
KW200LL5LH	5	007887
KW200LL5LH RCL RCS	5	067116
KW200LL5RH	5	007888
KW200LL5RH RCL RCS	5	067117
KW200SNL3LH RCL&S	3	081830
KW200SNL3RH RCL&S	3	081827



Delta (DL)



Dorian (DNL)



Privacy Set – Stocked 2 3/8" backset.

KW300DL3RCL RCS	3	040891
KW300DL5RCL RCS	5	040892
KW300DL26D	26D	040894
KW300DL26D RCL RCS	26D	067127
KW300DNL5 RCL RCS	5	040895
KW300LL3LH	3	007979
KW300LL3LH RCL RCS	3	066889
KW300LL3RH	3	007980
KW300LL3RH RCL RCS	3	066890
KW300LL5LH	5	007981
KW300LL5RH	5	007982



Lido (LL)

Entrance Lockset – Levers locked by inside turn button or outside by key in knob. (Copa) Stocked 2 3/8" backset

KW400DL5RCL RCS	5	040908
KW400DL26D	26D	040909
KW400LL3LH	3	008041
KW400LL3LH RCL RCS	3	067092
KW400LL3RH	3	008042
KW400LL3RH RCL RCS	3	067093
KW400LL5LH	5	008043
KW400LL5LH RCL RCS	5	067094
KW400LL5RH	5	008044
KW400LL5RH RCL RCS	5	067095



Entrance Keyed Leverset

KW405DL3RCL RCS	3	077416
KW405DL26D RCL RCS	26D	081040
KW405LL3LH RCL RCS	3	070147
KW405LL3RH RCL RCS	3	070148

Mfg. # Fin. EZ #

Dummy Lever

KW488LL3LH	3	008099
KW488LL3RH	3	008100
KW488LL5LH	5	008101
KW488LL5RH	5	008102

3 - Bright Brass **5** - Antique Brass **26D** - Satin Chrome

RCL - Round Corner Latch **RCS** - Round Corner Strike



Combo Sets

660 Series Standard Duty Deadlocks

- Cross Bore: 2 1/8" • Edge Bore: 1" • Bolt: 1" throw • Rotating Cylinder Guard • Door Thickness 1 3/8" to 1 3/4"

Mfg. #	Fin.	B.S.	EZ #
<i>660 Single Cylinder</i>			
KW660 3K3	3	Adjustable	026732
KW660 3K3CP	3	Adjustable	040967
KW660 3MK12112	3	Adjustable	040968
KW660RFAL3K3	3	RFAL	026734
KW660 3 RC AL	3	Adjustable	076651
KW660 3RCL RCS KD	3	Adjustable	061404
KW660 3RCL RCS K3	3	Adjustable	063244
KW660 5K3CP	5	Adjustable	040971
KW660 5K3	5	Adjustable	040970
KW660 5RCL RCSK3	5	Adjustable	066888
KW660 15A RCL RCS KA3	15A	Adjustable	074647
KW660 26D KA3	26D	Adjustable	026735
KW660 26D KD MK12112	26D	Adjustable	079345
KW660 26D RCL RCS K3	26D	Adjustable	066883
KW660 26D RFL2734 K3	26D	RFAL	073411



665



660

<i>665 Double Cylinder</i>			
KW665 3K3	3	Adjustable	026740
KW665 3K3CP	3	Adjustable	040976
KW665 3MK12112	3	Adjustable	040973
KW665 3RCL RCS KD	3	Adjustable	061405
KW665 3RCL RCS K3	3	Adjustable	063248
KW665RFAL3 5278K3	3	RFAL	026741
KW665 3RFAL RCS K3	3	RFAL	067096
KW665 5K3CP	5	Adjustable	040977
KW665 5K3	5	Adjustable	040975
KW665 5RCL RCSK3	5	Adjustable	066881
KW665 15A RCL RCS KA3	15A	Adjustable	074648
KW665 26D K3	26D	Adjustable	026742
KW665 26D KD MK12112	26D	Adjustable	079346
KW665 26D RCL RCSK3	26D	Adjustable	066876
KW665 26D RFL2734 K3	26D	RFAL	073412

- AL = Adjustable bolt
- MK = Master keyed
- RCAL = Radius Corner Adj. Latch
- RFAL = Drive-in adjustable bolt
- CP = Clear Pack

663 One Sided Deadlock – Use only on wood doors. Turnpiece operates from interior only; no exterior locking

KW663 3	3	2 3/8"	008160
KW663 3RCL RCS	3	2 3/8"	066868
KW663 3RFL	3	2 3/8" D.I.	040979
KW663 3RFL RCS	3	2 3/8" D.I.	066869
KW663 5	5	2 3/8"	008161
KW663 5 RCL RCS	5	2 3/8"	066870
KW663 5 RFL RCS	5	2 3/8" D.I.	080760
KW663 26D	26D	2 3/8"	008159
KW663 26D RCL RCS	26D	2 3/8"	066867
KW663 26D RFL	26D	2 3/8"	085084



663

Exterior Plate Kit
(converts 663 to 667)

Mfg #	EZ #
KW664 3	074037
KW664 5	074038
KW664 26D	075958

Entry / Deadbolt Combo Sets

Mfg. #	Fin.	Backset	EZ #
<i>Single Cylinder Sets (1-400T; 1-660) KA6</i>			
KW690T3CP K6	3	Adj.	026750
<i>Double Cylinder Sets (1-400T; 1-665) KA2</i>			
KW695T3K2CP	3	Adj.	026753
KW695T3CP RCAL RCS K2	3	Adj.	066859





Gatelatch Deadlatch

- Door Prep: Front - 2 1/8"
- Door Thickness 1 3/8" to 1 3/4" gates

Mfg. # B.S. EZ #

588 Single Cylinder

KW588 3	2 3/8"	040963
KW588 5	2 3/8"	040964

599 Double Cylinder

KW599 3	2 3/8"	084618
KW599 5	2 3/8"	040966



Round Pocket Door Lock

- Fits 2 1/8" face bore
- Easy Installation- no more notching

Mfg. # B.S. EZ #

KW335 3	2 3/8"	080601
KW335 26D	2 3/8"	080602



Trim Rosettes and Modernization Kits

Mfg. #	Fin.	Description	EZ #
KW239 3	3	Colonial Handle	007899
KW288 3	3	3 7/8" x 4 1/8" rect.	007934
KW293 3	3	3 1/8" round	007936
KW293 5	5	3 1/8" round	007937
KW293 26D	26D	3 1/8" round	026684
<i>Modernization Kits (includes latch face and strike)</i>			
KW214 3	3	3 1/2" x 10 1/2"	007892
KW214 5	5	3 1/2" x 10 1/2"	007893
KW214 26D	26D	3 1/2" x 10 1/2"	007891
KW215 3	3	3 3/8" x 7 1/4"	007895
KW215 5	5	3 3/8" x 7 1/4"	007896



780 Series UltraMax Deadlocks

Full 1" throw adjustable deadbolt with hardened steel roller insert resists hacking. Heavy gauge steel reinforcing plate will withstand even the heaviest blows. High security 6-pin cylinder makes it difficult to pick. Extra large interior turnpiece for easier locking and unlocking. 50 year warranty. Endorsed by the National Police Officers Association of America. Made in the U.S.A.

Mfg. # Fin. EZ #

780 Single Cylinder

KW780 3K2	3	040983
KW780 3KD W/5KEYS	3	078058
KW780 AL5K3	5	027723
KW780LO3K3	3	072211
KW780 15A RCL&S	15A	076730
KW780 26D	26D	044982

785 Double Cylinder

KW785 3K2	3	040985
KW785 5K2	5	069000
KW785LO3K3	3	072212
KW785 15A RCL&S	15A	076731
KW785 26D	26D	044985



- Cross Bore: 2 1/8", Edge Bore: 1"
- Door Thickness: 1 3/8" to 1 3/4"
- Front removable cylinder with rekeying tool
- ANSI A156.5 Grade 2
- Backset - adjustable 2 3/8" to 2 3/4"
- LO = Lifetime Finish Warranty



Handlesets

Installation Kits



UltraMax Solid Brass Entrance Handlesets

- Forged solid brass construction • Adjustable backset
- Full 50 year warranty against mechanical failure
- Maximum security, heavy gauge deadbolt strike with extra long 3" screws
- Easy installation in all solid, hollow core and metal doors

Mfg. #	Fin.	Function	EZ #
<i>Chelsea</i>			
KW800CE LIP3BP	3	Sgl Cyl	062528
KW800CE LIP LO3BP	3	Sgl Cyl	072280
KW800CE LIP5BP	5	Sgl Cyl	062529
KW800CE LIP 15A RCL RCS	15A	Sgl Cyl	075970
KW801CE LIP LO3BP	3	Dbl Cyl	072281
KW801CE LIP5BP	5	Dbl Cyl	062533
KW801CE LIP 15A RCL RCS	15A	Dbl Cyl	075971
KW802CE LIP LO3	3	Dummy	076535
<i>Arlington</i>			
KW800AN LIP LO3 RCL RCS	3	Sgl Cyl	075972
KW800AN LIP5BP	5	Sgl Cyl	062532
KW800AN LIP 15A RCL RCS	15A	Sgl Cyl	075968
KW801AN LIP LO3 RCL RCS	3	Dbl Cyl	075973
KW801AN LIP5BP	5	Dbl Cyl	062534
KW801AN LIP 15A RCL RCS	15A	Dbl Cyl	075969
KW802AN LIP LO3	3	Dummy	076536

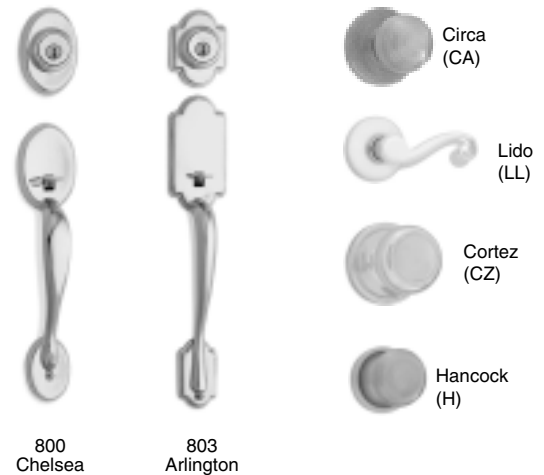

Handlesets less interior trim - order trim pack separately



BP - Box Pack LO - Lifetime Finish Warranty

Inside Trim Pack

Mfg. #	EZ #	Mfg. #	EZ #	Mfg. #	EZ #
<i>Single Cylinder Interior Assembly</i>		<i>Double Cylinder Interior Assembly</i>		<i>Dummy Interior Assembly</i>	
KW966CA3	028961	KW967CA3	082942	KW968CA3	082953
KW966CA5	082940	KW967CA5	082952	KW968CA5	082962
KW966CA 15A	078169	KW967CA 15A	082941	KW968CZ3	082954
KW966CZ3	082933	KW967CZ3	082943	KW968CZ5	082955
KW966CZ5	082939	KW967CZ5	082951	KW968H3	082956
KW966H3	082935	KW967H3	082945	KW968H5	082957
KW966H5	082936	KW967H5	082946	KW968LL3LH	082958
KW966H 15A	082934	KW967H 15A	082944	KW968LL3RH	082959
KW966LL3LH	028960	KW967LL3RH	082948	KW968LL5LH	082960
KW966LL3RH	028958	KW967LL3LH	082947	KW968LL5RH	082961
KW966LL5LH	082937	KW967LL5RH	082950		
KW966LL5RH	082938	KW967LL5LH	082949		

Professional Door Lock Installation Kit

All In One Boring Jig

- Unique design for drilling wood, fiberglass and metal doors
- Drills 2 1/8" and 1 1/2" standard door prep

Quick Boring System

- Tool-free backset adjustment
- Quick drill bit adapter changes drill bits without re-chucking

Trouble-Free Setup

- Molded kit box holds assembled jig
- No assembly or tear-down required
- Ergonomic handle design ensures firm clamping

Mfg # KW138 EZ # 073992



- A. Quick drill bit adapter
- B. 1" heavy-duty DEWALT® spade bit
- C. Aluminum template measuring guide
- D. Mortise tools with square and round corner replaceable blades
- E. Heavy-duty kit box
- F. 2 1/8" multi-spur bit for wood doors
- G. In-line guide arm for wood doors
- H. 2 1/8" hole saw for metal and fiberglass doors
- I. 1 1/2" adapter ring
- J. Depth stop guide
- K. Strike locator
- L. In-line guide arm for metal and fiberglass doors
- M. 1 1/2" multi-spur bit

Pins

Mfg. #	Description	EZ #
KW3101	Bottom Pin	043115
KW3103	Bottom Pin	007998
KW3105	Bottom Pin	043116
KW3106	Bottom Pin	008000
KW3108	Master Pin	008002
KW3112	Master Pin	008004
KW3113	Master Pin	008005
KW3114	Master Pin	008006

Replacement Parts

Dead Latches

Mfg. #	Backset	EZ #
KW2975 3	2 3/8"	007947
KW2975 26D	2 3/8"	007946
KW2996 3	2 3/8" RFLDI	007958
KW3003 3	2 3/4"	007986
KW3003 26D	2 3/4"	029423
KW3008 3	2 3/4" RCL	007991
KW2995 3	2 3/4" RFLDI	007956
KW3014 3	5"	007994

**Adjustable Dead Latch
(2 3/8" – 2 3/4") (4 way)**

KW2955 3	Square/RFL	007939
----------	------------	--------

Deadlatch for Gatelock

KW3277 3	2 3/8"	041002
----------	--------	--------

Radius Corner Spring Latch

KW2993 3	2 3/8" RCL	007951
----------	------------	--------

Spring Latches

KW2974 3	2 3/8"	007942
KW2974 26D	2 3/8"	007941
KW2999 3	2 3/4" RCL	007962



**Adjustable Dead Bolts
(2 3/8" – 2 3/4") For 660/780/880**

Mfg. #	Description	EZ #
KW4504 3CP	Square/ RFL	062784

RFLDI = Round Face Latch/Drive In

Replacement Parts (cont.)

Dead Bolts for 660 Series

Mfg. #	Backset	EZ #
KW2728 3	2 3/8"	007917
KW2728 26D	2 3/8"	007916
KW2729 3	2 3/4"	007921
KW2729 26D	2 3/4"	007920
KW2734 3	2 3/8" RFLDI	007924
KW2735 3	2 3/4" RFLDI	007925

RFLDI = Round Face Latch/Drive In

Strikes

Mfg. #	Description	EZ #
KW3028 3	T Strike	026765
KW3028 26D	T Strike	065426
KW3437 3	Full Lip	008013
KW3222 3	Deadbolt	008088

Tailpieces

Mfg. #	Description	EZ #
<i>Single Cylinder 660/880</i>		
KW4991	Std Door Female	008110
KW4992	Thick Door Female	008111
<i>Double Cylinder 665/885</i>		
KW4993	Std Male	008106
KW4994	Thick-Male	008109
KW4987	Std-Female	008107
KW4988	Thick-Female	008108

Thick Door Packages

Mfg. #	Description	EZ #
KW6129 3	For 660	008146
KW6130 3	For 665	008147
KW4220	For 780	043103

Miscellaneous

Mfg. #	Description	EZ #
KW152	Plug Follower	007866
KW1850 3	"400" Knob Lock Cyl.. KD	007869
KW4215	DB plug clip	008054
KW4345	Lockset Plug clip	008061
KW5333	Spindle Assm.	008118
KW6099 3	Screw pack (665)	041016
KW6171 3	Screw pack (660)	041015
KW81804	Titan lever rekey tool	061611

Miscellaneous (cont.)

Mfg. #	Disc	EZ#
IL1176RK	Titan knob rekey tool	007098
KW111	1" Dia latch mortiser	007861
KW141	Full lip strike	007860
KW1467	Cylinder removal tool	007863
KW127	2 1/8" Multi-spur bit	007858
KW151	Mortise strike	007865

Key Blanks

Standard nickel plated
Mfg. # KW1063NP
EZ # 007852
Oval Bow Blank
Mfg. # KW83559 6PIN KEY BLANK
EZ # 070236
Universal Big Bow Blank
Mfg. # KW81208 001 KEY BLANK
EZ # 070238



272 UltraMax Keying Kit

Includes: Pins, springs, screws, plug clips, cylinder removal tool, rekeying tool, plug following tool, key gauge and much more.

Mfg # KW272 EZ # 007911





Emerald Wedge Pro Kit

- Metal Construction
- Wedge-Shaped Box
- Dura-View™ Pin Tray
- Hardcoat Metallic Green
- Plastic Coated Chart
- Color Passport™ Pin Chart
- 100% Larger Pin Tray Numbers

Mfg # LBEPK003 EZ # 008260

- .003 Increments
- 124 Sizes
- Top Pins: .010 - .200
- Bottom Pins: .156 - .360

Mfg # LBEPK005 EZ # 008261

- .005 Increments
- 102 Sizes
- Top Pins: .010 - .300
- Bottom Pins: .150 - .360



Professional Series

- Metal Construction
- Dura View Tray
- Plastic coated color passport pin chart
- Hardcoat Metallic Green

Mfg # LBLPK003 EZ # 008290

- .003 Increments
- 124 sizes
- Top Pins: .010 - .200
- Bottom Pins: .156 - .360

Mfg # LBLPK005 EZ # 008308

- .005 Increments
- 102 sizes
- Top Pins: .010 - .300
- Bottom Pins: .150 - .360



Universal Kit - Woody Classic

- Color Passport Pin Chart
- Triple Latch Construction for Extra Security
- .005 Increment
- 92 Sizes
- Center Slide-Out Drawer

LBLWK005 EZ # 050097

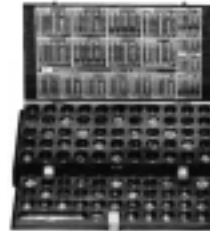

Interchangeable Core ANNEX

Load and unload interchangeable core pins, springs and caps with only one instrument for both functions

Mfg # LBLICCB EZ # 069880



Mini DUR-X Pin Kits

- Super tuff polyethylene
- New platform design insert
- Location chart
- Includes springs & pins
- Actual size 7 1/2" x 4 1/2" x 1 1/2"



LBLMDKWK

Kwikset

EZ # 043008

LBLMDWSR

Weiser

EZ # 041702

LBLMDSCH

Schlage

EZ # 008286

Interchangeable Core Kit

For Best® A2, Arrow, Falcon or Eagle interchangeable cores. Original design pins: 360 full hard brass; 28 sizes. Includes springs, caps, 6 and 7 pin covers.

Mfg # LBBFK108

EZ # 036435





Universal Color Coded Replacement Pins

3/1000 INCREMENT PINS

- 3/1000 increment pins are packed in LAB's unique SmartPac with 144 pcs. (1 gross) per pack.
 - Bottom Pins are produced with a standard nose and a flat center with radius corners on the back end.
 - Top and Master Pins are produced with flat centers and properly chamfered corners.
 - Produced from full-hard #360 alloy brass.
- Available sizes: Bottom - .126 thru .360 Top/Mast. - .024 thru .141

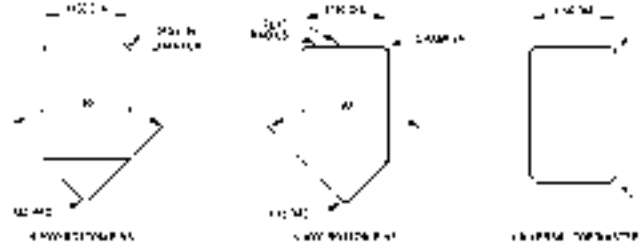

5/1000 INCREMENT PINS

- 5/1000 increment pins are packed in LAB's unique SmartPac with 144 pcs. (1 gross) per pack.
 - Bottom Pins are produced with a standard nose and a flat center with properly chamfered corners on the back end.
 - Top and Master Pins are produced with flat centers and properly chamfered corners.
 - Produced from full-hard #360 alloy brass.
- Available sizes: Bottom-.115 thru .360 Top/Mast-.010 thru .240

Weiser Pins

BOTTOM PINS

Mfg#	EZ #
LB8553-0	041716
LB8553-1	041717
LB8553-2	041718
LB8553-3	041719
LB8553-4	041720
LB8553-5	041724
LB8553-6	041725
LB8553-7	041726
LB8553-8	041727
LB8553-9	041728

MASTER PINS

Mfg#	EZ #
LB#2	041729
LB#3	041730
LB#4	041731
LB#5	043009
LB#6	041732
LB#7	041733
LB#8	041734
LB#9	041735

Kwikset Pins

BOTTOM PINS

Mfg. #	EZ #
LB3100	041703
LB3101	041704
LB3103	041705
LB3105	041706
LB3106	041707
LB3107	041708

MASTER PINS

Mfg. #	EZ #
LB3108	041709
LB3110	041710
LB3112	041711
LB3113	041712
LB3114	041713
DRIVER PIN (top)	
LB1858	041715

Replacement Cylinder Springs

Mfg#	Description	EZ #	Mfg#	Description	EZ #
LB115 SHORT	Short Spring	041018	LBBFSR	Best/Falcon I/C Spring	042191
LB115L	Long Spring	042153	LBSRINGS IC SHORT	I/C Short Spring	047657
LBC503 115	Schlage Cap Spring	041766			



Pins And Springs • Shims

Best Pins

Mfg#	OEM/ZIP#	EZ #
LB0B (0 Bottom)	0A	042154
LB1B (1 Bottom)	1A	042155
LB2B (2 Bottom)	2A	042156
LB3B (3 Bottom)	3A	042158
LB4B (4 Bottom)	4A	042159
LB5B (5 Bottom)	5A	042160
LB6B (6 Bottom)	6A	042168
LB7B (7 Bottom)	7A	042170
LB8B (8 Bottom)	8A	042172
LB9B (9 Bottom)	9A	042173
LB2T (2 Top)	2B	042174
LB3T (3 Top)	3B	042175
LB4T (4 Top)	4B	042176
LB5T (5 Top)	5B	042177
LB6T (6 Top)	6B	042178

Mfg#	OEM/ZIP#	EZ #
LB7T (7 Top)	7B	042179
LB8T (8 Top)	8B	042180
LB9T (9 Top)	9B	042181
LB10T (10 Top)	10B	008309
LB11T (11 Top)	11B	042182
LB12T (12 Top)	12B	042183
LB13T (13 Top)	13B	042184
LB14T (14 Top)	14B	042185
LB15T (15 Top)	15B	008347
LB16T (16 Top)	16B	042186
LB17T (17 Top)	17B	042187
LB18T (18 Top)	18B	042188
LB19T (19 Top)	19B	042189
LBCAP1027M	Y21C	042190

Schlage Pins

TOP PINS

Mfg. #	EZ #
OE34 101	011499
OE34 102	011500
OE34 103	011501

MASTER PINS

Mfg. #	EZ #
OE34 202	011502
OE34 203	011503
OE34 204	011504
OE34 205	011505
OE34 206	011506
OE34 207	011507
OE34 208	011508
OE34 209	011509

BOTTOM PINS

Mfg. #	EZ #
OE34 300	011510
OE34 301	011511
OE34 302	011512
OE34 303	011513
OE34 304	011514
OE34 305	011515
OE34 306	011516
OE34 307	011517
OE34 308	011518
OE34 309	011519

CAP PINS

Mfg. #	EZ #
LBC503 116	041767

Ear Light

- LED high intensity focused beam – adjustable vertically and horizontally
 - Weighs less than 1 oz
 - Two CR-2016 lithium batteries included
 - Comfortable padded universal fit around the ear
- Mfg # LBLABLED EZ # 085448



Shim Stock

Mfg#	Description	EZ #
HWSCS25	Curved Shim	026438

Cylinder Cap Removal Tool

Mfg # LBLCR005
EZ # 079064



SmartGard - Serial Access Control

Smartgard is access control for your safe. Multiple users, audit trail, dual combination and adjustable time delay are included

Features:

- Wrong try penalty
- Signal to disable lock - optional battery/alarm box required
- System status and audit trail shown on LCD or optional printer
- Battery box contains six user supplied C-cell alkaline batteries
- U.L. listed, Made in the USA • External battery compartment
- 4003 Large battery box

Programmable Features:

- Manager mode • Multiple users • Dual combination
- Time delay: delay period = 1-99 min, open period = 1-99 min
- Time delay override • Silent signal alarm
- Time lock: set one standard lock period per day
Special events - takes precedence over standard week settings
One programmable lock time - applies to each day of standard week
- Language: manager LCD display in English



4003 Large Battery Box - Included
4002 Large Battery Box - Optional

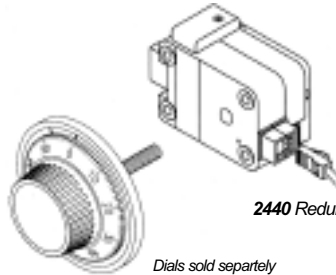

2440 Redundant Lock

Dials sold separately

Mfg. #	Description	EZ #
IG49001-III	Smartgard Logic LB 3	071330
IG3270	Rev. Swingbolt w/screws	081021
IG2440 1	Redundant lock	083118

33E Series Electronic Combination Lock

Direct replacement for most mechanical combination locks. Use one user supplied 9V battery. Advanced programmable features may be set with optional Model 3045 handheld programmer.

ComboGard Features:

- Direct replacement - most mechanical combination locks
- Wrong try penalty • Signal to disable lock - optional alarm box required
- External emergency power terminals • Uses one user supplied 9V alkaline batteries
- U.L. listed • Made in the USA

ComboGard Programmable Features (using 3045 programmer):

- Second user • Dual control • Time delay override • Manager mode
- Time delay: delay period = 1-99 min, open period = 1-19 min
- Silent signal alarm, remote override signal (optional alarm box required)



ComboGard



Mfg. #	Description	EZ #
IG33E1	ComboGard deadbolt w/screws	071319
IG33E2	ComboGard springbolt w/screws	071320
IG2788	Small battery box	071326
IG4002	Large battery alarm box (optional)	071328
IG3045	Programmer (hand held)	071329
IG4001	Large battery box (optional)	074192

Combination Locks



Dials & Rings • Mechanical Locks

SafeGard - Digital Combination Lock

Electronic lock fits most safes. Uses 2 9V batteries located in 3000 housing. Advanced programming possible with 3045

Programmable Features:

- Second user • Dual control
- Time delay: delay period = 1-99 min, open period = 1-19 min
- Time delay override
- Silent signal alarm, remote disable signal, remote override signal (optional alarm box required)



Mfg. #	Description	EZ #
IG3600	Complete SafeGard Lock	074194
IG3260	Lock non-handed w/screws	074193

LG Basic - Electronic Combination Lock

Complete economy lock with reversible swingbolt. No advanced programming

Standard Features:

- Manager Mode - manager and one user combination
- Wrong try penalty • U.L. listed • Made in USA
- Outside battery compartment - located under input housing
- User supplied 9V alkaline battery operated



Mfg. #	Description	EZ #
IG3802	LG Basic complete w/screws	071325
IG3802 1	LG Basic complete / brass finish	076122
IG3716	Adapter mount plate	076123

Dial & Rings

Mfg. #	Description	Finish	EZ #
IG1777	Flat gard dial & ring w/screws	Satin Chrome	071337
IG1779	Key locking dial & ring w/screws	Satin Chrome	071338
IG2085SC	Vision Gard dial & ring w/screws	Satin Chrome	071339
IG2090SC	Vision Gard key lock w/screws	Satin Chrome	071340
IG2090BB	Vision Gard key lock w/screws	Bright Brass	071341
IG2090BC	Vision Gard key lock w/screws	Bright Chrome	071342
IG2090B	Vision Gard key lock w/screws	Black & White	071343



IG1777



IG2085

Combination Locks

Mfg. #	Description	EZ #
IG1985	Group 1, 3-wheel lock w/screws	071336
IG3330	Group 2, 3-wheel lock w/screws	071334
IG3332	Group 2M, 3-wheel lock w/screws	071335



1985
Group 1, 3-Wheel



3330
Group 2, 3-Wheel



3332
Group 2m, 3-Wheel

Misc.

Mfg. #	Description	EZ #
IG2200	Key lock for safe	071344
IG2218	5 keys, random cut	071345
IG2213	Set up key for 2200	071346
IG2226	Key hole cover	071347



2218



2200
Key Lock



2226
Key Hole Cover



4041 Series

SMOOTHEE® is a heavy duty, double lever arm closer designed for institutional and other high traffic applications.

Mfg #	Description	EZ #
LCP4041ALUM W/TB	Aluminum closer w/ PA	008568
LCP4041 DURO	Duro. Closer w/ PA	043081
LCP4041H ALUM W/TB	Alum. hold open closer w/ PA	008570
LC4041EDA AL TB	Aluminum w/extra heavy arm	077246
LC4041EDA DU TB	Duro w/extra heavy arm	077247
LC4041H CUSH AL TB	Aluminum w/cush-n-stop arm, hold open	029331
LC4041 CUSH AL TB	Aluminum w/cush-n-stop arm	027713

TB - Thru bolt

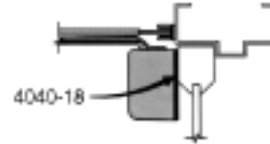
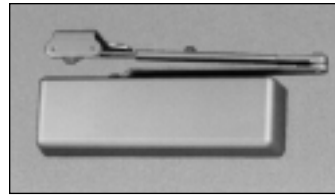

Drop Plate Required for hinge side mount where top rail is less than 3 3/4" (95mm). Plate requires 2" (51mm) minimum top rail.

Mfg. # LC4040 18ALUM EZ# 063963

4631 Series

Electrically powered Auto-Equalizer™ automatically opens interior and exterior doors with exceptionally quiet and smooth operation. Non handed, non sized.

Mfg. # LC4631AL EZ # 084995



1461 Series

The **1461 SUPER STOCK®** is a double lever arm, slim line closer designed for use on narrow head frames and top rails.

Mfg. #	Description	EZ #
LCP1461AL R/PA	Adjustable 1 thru 4 alum.	066354
LC1461DKBRZ R/PA	Adjustable 1 thru 4 duro	066357



Shown with parallel arm

1521 Series

The **1521 Commercial Closer** is non-handed, can be mounted pull side, push side or parallel arm. Suitable for doors hung on hinges or pivots.

Mfg. #	Description	EZ #
LC1521AL R/PA	Adjustable 1 thru 4 alum	066355
LC1521DKBRZ R/PA	Adjustable 1 thru 4 duro	066358



Shown with parallel arm

LCN 1371 Series "QUEST"

Non-handed and non-sized closer gives you maximum mounting flexibility and power (adjustable up to 5 power). With Quest, closer installation has never been faster! Install closers in less than 10 minutes: 1) apply the "peel and stick" template to the door and frame. 2) Mount the Unique, patented Rapidor bracket. 3) Install the closer.

- For aluminum, hollow metal or wood doors and frames
- Can be used with hinge or pivot mounted doors
- Adjustable ANSI Size 1-5
- Meets ADA requirements
- All weather hydraulic fluid
- 10 year warranty
- Can mount: pullside, over door and parallel arm



Mfg#	EZ #
LC1371AL	069591
LC1371DU	069972
LC1371H AL	069593
LC1371H DU	069973
LCP1371AL	083884
LCP1371BRZ	083885

Accessories

Mfg. #	Description	EZ #
LC1370 18PA ALUM	Drop plate	071772
LC1370 18ALUM	Mounting plate	071056
LC1370 62PA	P/A Shoe bracket	080918

Power Supplies

Cobra

- 100 code capacity, programmable at keypad
- 4 AA batteries provide over 80,000 cycles
- Accepts SFIC cylinder, dummy plug provided
- Right handed, field reversible
- 2 3/4" backset with 1/2" latchbolt
- Door thickness from 1 1/2" - 2"

Mfg. #	Desc.	EZ #
LKMPC LRP	Cover plate	076969
LKMPC SK	Shim plate for 1 3/8" door	076986
LKMPC17RH	Lock 100 user	076983
LKMPC06RH LC626	Lock less cylinder	076673

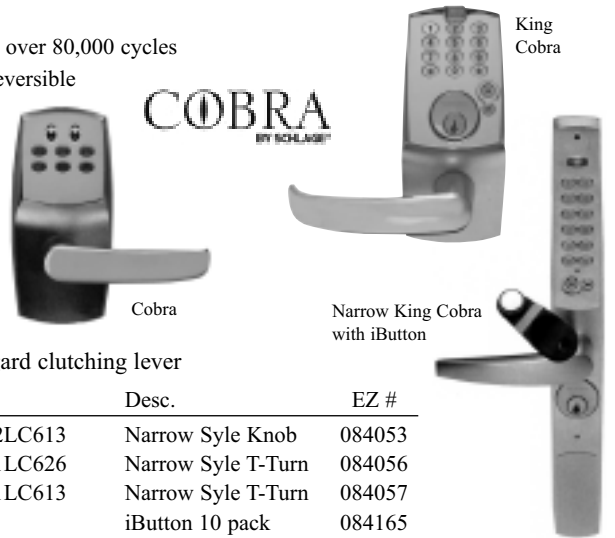

King Cobra

- iButton credential reader
- Schlage Everest™ cylinder
- Vandlgard clutching lever

Mfg. #	Desc.	EZ #	Mfg. #	Desc.	EZ #
LKKC5196LC17 626	King Cobra	084080	LKKC9232LC613	Narrow Syle Knob	084053
LKKC5596 17RH LC626	King Cobra Mortise	084084	LKKC9321LC626	Narrow Syle T-Turn	084056
LKKC9111LC626	Narrow Syle Lever	084050	LKKC9321LC613	Narrow Syle T-Turn	084057
LKKC9111LC613	Narrow Syle Lever	084051	LKIBF10	iButton 10 pack	084165
LKKC9232LC626	Narrow Syle Knob	084052	LKKCWAP15 626	5 x 15 Mod. plate	084048
			LKKC LRP	Cover plate	084047

PRO5100 Series Electronic Cylindrical Locksets

- Allows for up to 120 numerical (3-8 digit) access codes
- Schlage Everest cylinder is standard for mechanical key over ride

Mfg # LKPRO5196 06RH LC 626	EZ # 076663
Mfg # LKPRO5196 17RH LC 626	EZ # 082852

LC = Less cylinder



PRO993 Exit Trim

- Stand-alone, battery powered exit trim for use on door where an exit device is required for egress
- Designed to be used with Von Duprin 98/99 exit devices
- Can be manually programmed for up to 120 keycodes right at the trim

Mfg # LKPRO993	EZ # 073380
----------------	-------------



Power Supplies

Mfg. #	Description	EZ #
LK505	1 amp output at 12 or 24 VDC	008603
LK510	3 amp @ 12 VDC or 2 amp @ 24 VDC	072189
LKCMR	Control module rack	073457
LKDCM	Dual control module	073452
LKEIR	Emergency interface relay	073453
LKSBP2	Standby battery pack & cable kit	008592



LK505



LK510

Accessories & Entry Devices

Mfg. #	Description	EZ #
LK788 18	18" x 3/8" armored door cord less wire	073454
LK788 12	12" x 3/8" armored door cord less wire	085277
LK593P1 12VDC	Plug in transformer	073455
LKKP79PLUS	Select entry keypad	075812



LK593



KP79PLUS



4500 Series Deadbolt Locks

- Heavy duty cylinder housing • Reinforced free turning collars
- Cylinder set screws - allen wrench furnished
- Armored front shields set screws • Solid brass trim
- Uses standard mortise cylinder with A/R cam
- Two hardened steel pins • 1" throw bolt with 2 hardened steel pins
- Fits door 1 3/8" to 1 3/4", thicker doors use longer cylinders
- All deadbolts are stocked less cylinder/less bolt



4510 Single Cylinder



4520 Double Cylinder

Mfg. #	Finish	EZ #
<i>Single Cylinder Deadbolt – Less Cylinder & Bolt</i>		
LR4510 03 1 00 901	Polished Brass	041095
LR4510 05 1 00 901	Antique Brass	041096
LR4510 10 1 00 901	Satin Bronze	070896
LR4510 11 1 00 901	Dark Bronze	041098
LR4510 26 1 00 901	Polished Chrome	041100
LR4510 26D 1 00 901	Satin Chrome	041094
<i>Double Cylinder Deadbolt – Less Cylinders & Bolt</i>		
LR4520 03 1 00 901	Polished Brass	041108
LR4520 05 1 00 901	Antique Brass	041109
LR4520 10 1 00 901	Satin Bronze	062037
LR4520 11 1 00 901	Dark Bronze	041099
LR4520 26 1 00 901	Polished Chrome	041103
LR4520 22D 1 00 901	Satin Chrome	041107
<i>Double Cylinder Deadbolt – 2" Backset (complete)</i>		
LR4522 03 1 12 04 5K2	Polished Brass	041104

Blockers

- Protects latch and cylinder on aluminum frame doors
- 1100: 3" x 10 7/8" • 1120: 3 1/2" x 12"

Mfg. #	Keyway	EZ #
LR1100 13 3 00 001	Duranodic	035875
LR1100 28 3 00 001	Satin Alum.	035874
LR1120 28 3 00 001	Satin Alum.	035876

Bolts Only - Less Fronts

Mfg. #	B.S.	EZ #
--------	------	------

Standard 1" Deadbolt

LR4500 26D 5000	2 3/8"	035909
LR4500 03 5000	2 3/8"	041097
LR4510 03 5001	2 3/4"	041102
LR4510 26D 5001	2 3/4"	041101
*LR4540 25 5014	2 3/8"	041110
*LR4550 25 5001	2 3/4"	041111

* LR4540 and LR4550 are Drive in

Miscellaneous Parts

Mfg. #	Keyway	EZ #
LR4230 03 5000	Adj. Collar	041093
LR4230 25 5000	Adj. Collar	041092
LR4500 84 5003	Cyl. Housing	041115
LR4510 25 5012	1 1/8 Face Plate	076078
LR4200 82 2017	Deadlock Cam	041074
LR4900 5004 03	2" Backset	041120
LR4900 84 5005	2" DB Housing	041119

Roses & Rose Assembly

Mfg. #	Desc.	EZ #
LR4500 03 5017	Standard Rose	041117
LR4500 05 5017	Standard Rose	041118
LR4500 25 5017	Standard Rose	041116
LR4500 03 5016	Thumb-Turn Rose	041113
LR4500 05 5016	Thumb-Turn Rose	041114
LR4500 25 5016	Thumb-Turn Rose	041112

Die Cast Rim Cylinders

No. 3200 Comp. Kwy (L200)

Mfg # LR3200 04 1 02 001

EZ # 008782



Surface Mounted Rim Locks

1200 Jimmy Proof Deadlock

Single Cylinder With 3200 cylinder

Mfg # LR1200 04 1 02 001 K2 EZ # 041033



1700 Drawer Locks

Mfg#	Cyl. Lgth.	Keyed	EZ #
LR1702 04 11 KD	7/8"	KD	008771
LR1702 04 11 KAEB032	7/8"	EB32	041044
LR1702 04 11 KAEB078	7/8"	EB78	008772
LR1700 04 1 20 002KA 092	7/8"	PB92	008774
LR1703 04 11 003 EB78	1 1/8"	EB78	041045



Profile Locks

Mfg#	Finish	Kwy	EZ #
<i>Profile Double Cylinder</i>			
LR53225SCO4KD	04	SC1	029279
LR53225KS04KD	04	KW1	041121
<i>Profile Single Cylinder</i>			
LR52225SC03KD	03	SC1	072149



53225



52225

Key Blank

Blank for 1700

Mfg # LRL400 EZ # 041123

Plugs

6 pin plug Russ. D1
Mfg # LR1531 25 3027
EZ # 041042

6 pin plug SC C-L
Mfg # LR1531 25 3528
EZ # 035886

6 pin plug Schlage E
Mfg # LR1531 25 3534
EZ # 041043



Grade 1 Heavy Duty Commercial

Meets ANSI A156.2 Series 4000 Grade 1

Trim: Knobs and roses are stainless steel, brass or bronze.
Lever complies with Barrier Free Accessibility Codes.
Lever zinc base material, plated to match finish symbol.
Roses are wrought brass or bronze.

Backset: 2 3/4" UL Listed, A label, single swing doors (4' x 8').

Latch: Solid brass 1/2" throw, reversible for RH or LH applications. Adjustable front for flat or beveled doors. 2 1/4" x 1 1/8" face plate.

Door: Adjustable from 1 3/8" - 2".

Strike: 4 7/8" x 1 1/4" ASA.

Cylinder: Comes supplied with Schlage 6 pin "C" keyway.

Keying: Keyed differently.

Case: Corrosion treated heavy gauge, cold-rolled, steel mechanisms.

Finishes: 3 - Bright Brass, 26D - Satin Chrome
32D - Satin Stainless Steel, 10B - Oil-rubbed Bronze

Lever Chassis:

Quality cast and machined stainless steel hubs mounted with heavy duty return springs. Cycle tested over one million cycles without any visible sag. Heavier rose liners material provides more attack resistance. Heat treated heavy gauge cold rolled steel spindles withstand 1000 pounds per inch of torque applied to the locked lever without gaining access.

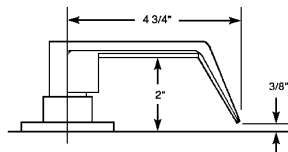

"B" Ball

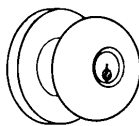

"P"
Plymouth



LF Series

Mfg. #	Design	Fin.	EZ #
Passage Sets			
LSLH1100B32D	Ball	32D	009177
LSLF2100 10B	Lever	10B	077538
LSLF2100 26D	Lever	26D	077539
Privacy Sets			
LSLH1200B32D	Ball	32D	009183
LSLF2200 10B	Lever	10B	077541
LSLF2200 26D	Lever	26D	077542
Entrance Locksets - Turn/Push-Button locking			
LSLH1000B3	Ball	3	009170
LSLH1000B10B	Ball	10B	009169
LSLH1000B32D	Ball	32D	009171
LSLH1000P32D	Plymouth	32D	009174
Entrance Leversets			
LSLF2000 10B	Lever	10B	077535
LSLF2000 26D	Lever	26D	077536
IC Entrance Leversets (less core)			
LSLF2000IC 26D	Lever	26D	077970
Store Locks - Key in either knob/lever, locks both knobs/levers			
LSLH1300B32D	Ball	32D	009189
Storeroom Locks - Outside knob/lever fixed. Entrance by key only. Inside always free.			
LSLH1400B32D	Ball	32D	009195
LSLF2400 10B	Lever	10B	077544
LSLF2400 26D	Lever	26D	077545
IC Storeroom Leversets (less core)			
LSLF2400IC 26D	Lever	26D	077971
Classroom Locks - Outer knob/lever locked/unlocked by key outside. Inner knob/lever always free			
LSLH1500B10B	Ball	10B	009199
LSLH1500B32D	Ball	32D	009201
LSLF2500 10B	Lever	10B	077547
LSLF2500 26D	Lever	26D	077548
IC Classroom Leversets (less core)			
LSLF2500IC 26D	Lever	26D	077972
Institutional Locks - Both knobs/levers fixed. Entrance by key in either knob/lever.			
LSLH1900B10B	Ball	10B	041190
LSLH1900B32D	Ball	32D	009206
LSLF2900 10B	Lever	10B	077550
LSLF2900 26D	Lever	26D	077551

Grade 1 Latches

Mfg. #	Description	EZ #
LS234 DL3	2 3/4" Deadlatch	009815
LS234 DL10B	2 3/4" Deadlatch	009814
LS234 DL32D	2 3/4" Deadlatch	009816
LS238 DL3	2 3/8" Deadlatch	009822
LS2 3/8 DL32D	2 3/8" Deadlatch	041194
LS2 3/4 SL32D	2 3/4" Springlatch	009819



Grade 2 Medium Duty Locksets

ANSI Certification: A156.2 Series 4000 Grade 2

Backset: 2 3/8" or 2 3/4". Drive-in available. Keyed locks are sold less latch.

Strike: 4 7/8" A.S.A

Latch: 1/2" throw solid brass extruded rod on all functions.

Door range: Adjustable from 1 3/8" – 1 3/4" standard.

Cylinder: Sold less cylinder

Finishes: 3 – Bright Brass
 5A – Antique Brass
 32 – Bright Stainless Steel
 32D – Satin Stainless Steel
 10B – Oil-rubbed Bronze

Standard Features:

- Cylindrical lock housing. Cold rolled steel mechanisms, zinc dichromated for corrosion resistance.
- Removable outside knob for easy cylinder rekeying.
- No exposed mounting screws.
- Locks will also accept LSDA K300 replacement cylinders as well as Lori, ASSA and Peaks.



"B" Ball



"P" Plymouth



100-ENTRANCE LOCK Turn/Push-button locking. Pushing and turning button locks outside knob requiring use of key until button is manually unlocked. Pushing button locks outside knob until unlocked with key or inner knob is turned.



110-PASSAGE LOCK Both knobs are always free.



120-PRIVACY LOCK Push-button locking. Can be opened from outside by emergency key, screwdriver or similar tool.



140-STOREROOM LOCK Outer knob fixed. Entrance by key only. Inner knob always free.



150-CLASSROOM LOCK Outer knob locked or unlocked by key from outside. Inner knob always free.

Mfg #	Design	Fin.	Backset	EZ #
<i>Passage Locksets</i>				
LS110B3	Ball	3	2 3/8"	027956
LS110B5A	Ball	5A	2 3/8"	027957
LS110B10B 2 3/8	Ball	10B	2 3/8"	041268
LS110B10B 2 3/4	Ball	10B	2 3/4"	027961
LS110B32 2 3/8	Ball	32	2 3/8"	041267
LS110B32 2 3/4	Ball	32	2 3/4"	027959
LS110B32D 2 3/8	Ball	32D	2 3/8"	027958
LS110B32D 2 3/4	Ball	32D	2 3/4"	027960
LS110P3	Plymouth	3	2 3/8"	028534
LS110P32D	Plymouth	32D	2 3/8"	028535
<i>Privacy Locksets</i>				
LS120B3	Ball	3	2 3/8"	027966
LS120B5A	Ball	5A	2 3/8"	027967
LS120B10B	Ball	10B	2 3/8"	041272
LS120B32	Ball	32	2 3/8"	060564
LS120B32D	Ball	32D	2 3/8"	027969
LS120P3	Plymouth	3	2 3/8"	028537
LS120P32D	Plymouth	32D	2 3/8"	028539
<i>*Entrance Locksets - Turn/Pushbutton Locking * (less latch & cyl.)</i>				
LS100B3	Ball	3	N/A	009309
LS100B5A	Ball	5A	N/A	009312
LS100B10B	Ball	10B	N/A	041262
LS100B32	Ball	32	N/A	009310
LS100B32D	Ball	32D	N/A	009311
LS100P3	Plymouth	3	N/A	009320
LS100P32D	Plymouth	32D	N/A	009322
<i>* Storeroom Locksets * (less latch & cyl.)</i>				
LS140B3	Ball	3	N/A	009373
LS140B5A	Ball	5A	N/A	009376
LS140B10B	Ball	10B	N/A	028541
LS140B32	Ball	32	N/A	009374
LS140B32D	Ball	32D	N/A	009375
LS140P3	Plymouth	3	N/A	009384
LS140P32D	Plymouth	32D	N/A	009386
<i>* Classroom Locksets * (less latch & cyl.)</i>				
LS150B 3	Ball	3	N/A	009400
LS150B 32D	Ball	32D	N/A	009402

** Keyed locks - Sold Less Cylinder / Less Latch **

Cylindrical Locksets



Parts • Handlesets

UL/ADA Grade 2 Key-In-Leversets

Locks conform with ANSI A156.2 Series 4000 Grade 2 and more than satisfy ADA requirements.

Features:

- Housing is of cold rolled steel and zinc dichromate finish for rust resistance. 2 1/8" diameter bore is required.
- UL listed, Solid brass, 1/2" throw latchbolt.
- Reversible, non-handed.
- Separate springs for each lever.
- All keyed locks are sold less cylinder/less latch.



Mfg#	Fin.	Backset	Function	EZ #
Passage Locksets				
LSL110 3	3	2 3/4"	Passage	029351
LSL110 10B	10B	2 3/4"	Passage	041269
LSL110 26	26	2 3/4"	Passage	060160
LSL110 26D	26D	2 3/4"	Passage	029352

Mfg#	Fin.	Backset	Function	EZ #
Privacy Locksets				
LSL120 3	3	2 3/4"	Privacy	029353
LSL120 10B	10B	2 3/4"	Privacy	041273
LSL120 26	26	2 3/4"	Privacy	060245
LSL120 26D	26D	2 3/4"	Privacy	029354
Entrance Locksets (less latch & cylinder)				
LSL100 3	3	L/L L/C	Entrance	005577
LSL100 10B	10B	L/L L/C	Entrance	005575
LSL100 26	26	L/L L/C	Entrance	060161
LSL100 26D	26D	L/L L/C	Entrance	005576
Storeroom Locksets (less latch & cylinder)				
LSL140 3	3	L/L L/C	Storeroom	005586
LSL140 10B	10B	L/L L/C	Storeroom	005584
LSL140 26	26	L/L L/C	Storeroom	060246
LSL140 26D	26D	L/L L/C	Storeroom	005585
Classroom Locksets (less latch & cylinder)				
LSL150 3	3	L/L L/C	Classroom	005589
LSL150 10B	10B	L/L L/C	Classroom	005587
LSL150 26D	26D	L/L L/C	Classroom	005588

Grade 2 Interchangeable Core Leversets

- Housing is of cold rolled steel and zinc dichromate finish for rust resistance. 2 1/8" diameter bore is required.
- UL listed, Solid brass, 1/2" throw latchbolt.
- Reversible, non-handed.
- Separate springs for each lever.
- All keyed locks are sold less core/less latch.
- 6 or 7 pin



Mfg#	Fin.	Function	EZ #
LSL100IC 3	3	Entrance	031161
LSL100IC 10B	10B	Entrance	041266
LSL100IC 26	26	Entrance	041264
LSL100IC 26D	26D	Entrance	041265
LSL140IC 3	3	Storeroom	041275
LSL140IC 10B	10B	Storeroom	041279
LSL140IC 26	26	Storeroom	041277
LSL140IC 26D	26D	Storeroom	041278
LSL150IC 10B	10B	Classroom	041285
LSL150IC 26D	26D	Classroom	041283

Grade 2 Knob and Lever Lock Parts

Mfg. #	Fin.	Backset	EZ #	Mfg. #	Fin.	Backset	EZ #
Springlatches				Deadlatches			
LS005 3	3	2 3/8"	009279	LS096 32D	32D	2 3/4"	009302
LS005 5A	5A	2 3/8"	009282	LS096UL3	3	2 3/4" UL	005574
LS005 10B	10B	2 3/8"	041286	LS096UL10B	10B	2 3/4" UL	005572
LS005 32	32	2 3/8"	009696	LS096UL26D	26D	2 3/4" UL	005573
LS005 32D	32D	2 3/8"	009281	LS104 3	3	2 3/8" DIL	027981
LS014 3	3	2 3/4"	009283	LS104 32D	32D	2 3/8" DIL	009333
LS014 10B	10B	2 3/4"	041287	LS105 32D	32D	2 3/4" DIL	009334
LS014 32	32	2 3/4"	009704				
LS014 32D	32D	2 3/4"	009285				
Deadlatches				Latch Extension			
LS085 3	3	2 3/8"	009293	LSEL5	5" link & sleeve		028533
LS085 5A	5A	2 3/8"	009296				
LS085 10B	10B	2 3/8"	041288				
LS085 32	32	2 3/8"	009294				
LS085 32D	32D	2 3/8"	009295				
LS096 3	3	2 3/4"	009300				
LS096 5A	5A	2 3/4"	009303				
LS096 10B	10B	2 3/4"	028532				
LS096 32	32	2 3/4"	009301				
				Cylinders			
				LSCYL C3	3	SC1	009050
				LSCYL C32D	32D	SC1	009051
				Key Blanks			
				LSLSDA10C		"C"	027983

Entrance Handlesets

- Solid brass one piece cylinder housing
- 1" throw deadbolt reinforced with hardened anti-saw rod
- Revolving cylinder collar
- Keylocking outside, tumbutton locking inside
- For doors 1 3/8" to 1 3/4"
- Adjustable backset 2 3/8" - 2 3/4"

Mfg #	Design	Fin.	EZ #
LS40EA3K	EA	3	035995
LS40EA5K	EA	5	009843



All Handlesets come with a ball knob as inside trim



(EA) Early American



Grade 3 Standard Duty Locksets

- High quality brass and steel construction • 5 pin solid brass cylinder
- Adjustable 2 3/8"–2 3/4" universal latch • 2 3/8" and 2 3/4" drive-in latches are available
- Full 1/2" projecting deadlatch • Keyed functions are KA4
- Adjustable 1 3/8" – 1 3/4" door thickness

Mfg#	Design	Fin.	EZ #	Mfg#	Design	Fin.	EZ #
<i>Passage Locksets</i>				<i>Storeroom Locksets</i>			
LS11B3	Ball	3	009752	LS14B 3K	Ball	3	009783
LS11B5	Ball	5	009754	LS14B 5K	Ball	5	009785
LS11B32D	Ball	32D	009753	LS14B 32D K	Ball	32D	035972
LS11S3	Standard	3	009755	<i>Storeroom Locksets</i>			
LS11S32D	Standard	32D	009756	LS14B 3W	Ball	3	035971
<i>Privacy Locksets</i>				LS14B 5W	Ball	5	030095
LS12B3	Ball	3	009775	LS14B32D K	Ball	32D	035972
LS12B5	Ball	5	009777	LS14B 32D W	Ball	32D	035973
LS12B32D	Ball	32D	009776	LS14B 32D SC1	Ball	32D	062600
LS12S3	Standard	3	009778	LS14S 32D W	Standard	32D	041134
LS12S32D	Standard	32D	009779				
<i>Entrance Locksets</i>							
LS10B 3K KA/4	Ball	3	035956				
LS10B 3W	Ball	3	035957				
LS10B 5K	Ball	5	035959				
LS10B 5W	Ball	5	035960				
LS10B 5S	Ball	5	062596				
LS10B 32D K	Ball	32D	035962				
LS10B 32D W	Ball	32D	035963				
LS10B 32D S	Ball	32D	062597				
LS10S 3W	Standard	3	028826				
LS10S 5W	Standard	5	041130				
LS10S32D K	Standard	32D	009737				
LS10S32D W	Standard	32D	041131				

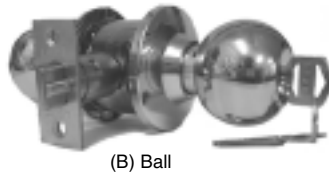

(B) Ball



(S) Standard

K - KW1 Keyway W - WR3 Keyway S - SC1 Keyway

Grade 3 Standard Duty Leverlocks

- Zinc cast lever electrostatically lacquered
- Nickel plated brass key
- Solid brass 5 pin tumbler cylinder
- 1/2" latch projection
- Adj. backset
- Adj. for 1 3/8" – 1 3/4" door thickness



Entrance function levers have key in Ball knob outside

Mfg#	Hand	Fin.	EZ #
<i>Entrance Leverlocks</i>			
LS50SY/BA LH 3K VP	LH	3	036000
LS50SY/BA RH 3K VP	RH	3	036001
LS50SY BA LH 5K VP	LH	5	009852
LS50SY BA RH 5K VP	RH	5	009853
<i>Passage Leverlocks</i>			
LS51SY LH 3 VP	LH	3	009856
LS51SY RH 3 VP	RH	3	009857
LS51SY LH 5 VP	LH	5	009858
LS51SY RH 5 VP	RH	5	009859
<i>Privacy Leverlocks</i>			
LS52SY LH 3 VP	LH	3	009862
LS52SY RH 3 VP	RH	3	009863
LS52SY LH 5 VP	LH	5	009864
LS52SY RH 5 VP	RH	5	009865



Parts And Accessories

Grade 2 Deadbolts

Mfg. #	Finish	EZ #
<i>Single Cylinder Deadbolts</i>		
LS220 3S ADJ BOLT	3	063536
LS220 5S ADJ BOLT	5	063537
LS220 32D S ADJ BOLT	32D	063538
LS220IC 32D	32D	085248
<i>Double Cylinder Deadbolts</i>		
LS225 3S ADJ BOLT	3	063539
LS225 5S ADJ BOLT	5	063540
LS225 32D S ADJ BOLT	32D	063541
LS225IC 32D	32D	085250
<i>Bolts - 2 3/8" Backset</i>		
LS9057N3	3	069239
LS9057N5	5	069240
LS9057N32D	32D	069241
<i>Bolts - 2 3/4" Backset</i>		
LS9058N3	3	069242
LS9058N5	5	069243
LS9058N32D	32D	069244



No. LS220



No. LS225

Locks sold less bolt
IC = Less Core

Security

- Massive 1" throw bolt with hardened steel rod to resist sawing (bolt sold separately).
- Security strike with 3" long screws.
- Mounted with rugged shroud to withstand rigorous tool attacks.
- Removable solid brass Schlage C Kwy 5-pin cylinder (drilled for 6).
- Rotating collar w/ insert resists wrenching.

Quality

- All metal construction.
- All exposed components are brass or stainless steel.

Convenience

- Easy replacement with after market and high security cylinders: Lori 1596, Ilco 7065, LSDA B400, ASSA 65611, Peaks 3400 & Schlage 20-724C.

Grade 3 Deadbolts

Mfg. #	Fin.	EZ #	Mfg. #	Fin.	EZ #
<i>Single Cylinder</i>			<i>Double Cylinder</i>		
LS20 3K	3	035974	LS25 32D W	32D	035991
LS20 3W	3	035975	LS25 32D 9098N KA4	32D	062606
LS20 5K	5	035977	<i>One-Sided Deadlock – Turnpiece operates from interior only; No exterior locking</i>		
LS20 5S	5	062602	LS26 3	3	035992
LS20 5W	5	035978	LS26 5	5	035993
LS20 32D K	32D	035980	LS26 32D	32D	035994
LS20 32D W	32D	035981	K - KW1 Keyway		
LS20 32D 9098N KA4	32D	062603	W - WR3 Keyway		
<i>Double Cylinder</i>			S - SC1 Keyway		
LS25 3K	3	035983			
LS25 3W	3	035984			
LS25 5K	5	035986			
LS25 5S	5	062605			
LS25 5W	5	035987			
LS25 32D K	32D	035989			



- Full 1" throw deadbolt with hardened steel rod insert
- 5 pin tumbler solid brass cylinder
- Revolving cylinder collar resists any attempt at twist-off
- Solid brass one piece cylinder housing
- Door thickness adjustable for door 1 3/8" to 1 3/4"
- Keyed functions are KA4
- Cross bore: 2 1/8"; Edge bore: 1"
- 2-Way UL Grade 2 Bolt, 2 3/8" - 2 3/4" backset

Replacement Parts and Accessories

Mfg. #	Description	EZ #	Mfg. #	Description	EZ #
LS9022 3	Grade 3 2 3/4" Fixed Bolt	009932	LS9091N 32D	Grade 3 Adjustable Deadbolt	009933
LS9022 32D	Grade 3 2 3/4" Fixed Bolt	043140	LS9098N3	Grade 3 4-Way Bolt	080756
LS9024N	Grade 3 2 3/4" Rfl. Bolt	069238	LS9098N5	Grade 3 4-Way Bolt	080757
LS9025N32D	Grade 3 RFL Bolt 2 Way Adjustable	071294	LS9098N32D	Grade 3 4-Way Bolt	080758
LS9077 3	Grade 3 4-way Tubular Deadlatch	009922	LS9204	Grade 3 Knoblock Tailpiece	009937
LS9078 3	Grade 3 4-way Spring Latch	009925	LS9205	Grade 3 Single Cylinder Tailpiece	009938
LS9081 3	Grade 3 Adjustable Deadlatch	009928	LS9206	Grade 3 Double Cylinder Tailpiece	009939
LS9081 32D	Grade 3 Adjustable Deadlatch	069256	LS9331	Grade 3 Cyl Cap Entry Lock	009949
LS9091 N3	Grade 3 Adjustable Deadbolt	069259	LS9351	Grade 3 Knoblock Plug Retainer	009950
LS9092N	Grade 3 Mobile Home Bolt	081018	LS9371	Plug Follower	026835
			LSLSDA-9	Grade 3 Key Blank	028084



Grade 3 Millennium Brass Lockset

Available in two functions to meet the needs of residential or light commercial use. Locksets come with the lifetime warranty guarantee on the finish with a no hassle return or replacement policy. Available in both the SC1 and WR5 keyways. The cylinders are designed with the exact spacings used by the original manufacturers.

Mfg#	Kwy.	Function	EZ #
LSMB11B3	-	Passage	068826
LSMB10B3S	SC1	Entry	068827
LSMB10B3S VP	SC1	Entry	070481
LSMB10B3W	WR5	Entry	068809
LSMB10B3W VP	WR5	Entry	070487



VP = Visual packaging for display purposes

Grade 3 Millennium Brass Entrance Handleset

Impressive style handle with coordinating deadbolt trim. This sleek design is available for replacement, upgrading and for new installations. The gripset features a one piece solid brass deadbolt cylinder housing with a 6 pin cylinder. The deadbolt has a revolving trim ring and 1" throw deadbolt with hardened steel anti-saw rod within the bolts.

Mfg#	Kwy.	Finish	Function	EZ #
LSMB40EA3W	WR5	3	Sgl Cyl	068819
LSMB40EA3S	SC1	3	Sgl Cyl	068831

POLISHED BRASS HANDLESETS,
KNOB LOCKS AND DEADBOLTS
LIFETIME FINISH WARRANTY
15 Year Mechanical Warranty

Grade 3 Millennium Brass Deadbolts

Available in a single or double cylinder version. Supplied with adjustable bolt for either 2 3/8" or 2 3/4" with a hardened rod insert. These deadbolts have the same keying specifications as the cylindrical locksets. For 1 3/8" or 1 3/4" thick doors. Free spinning cylinder collar.

Mfg#	Kwy.	EZ #	Mfg#	Kwy.	EZ #
<i>Single Cylinder</i>			<i>Double Cylinder</i>		
LSMB20 3S	SC1	068829	LSMB25 3S	SC1	068830
LSMB20 3S VP	SC1	070483	LSMB25 3S VP	SC1	070485
LSMB20 3W	WR5	068811	LSMB25 3W	WR5	068813
LSMB20 3W VP	WR5	070488	LSMB25 3W VP	WR5	070490



DC6120 Series - Grade 1 Surface Applied Non-Sized Closers

- Adjustable power closer with adjustable backcheck
- Adjustable closing and latch speeds
- Non-handed installation
- Tri-pack mounting. Regular arm, parallel arm or top jamb mounting
- Designed for high traffic situations
- 15 year replacement warranty

Mfg#	Size	Fin.	Max. Door Width	Max. Door Wt.	EZ #
LSDC6124PA BC AL	1-4	AL	42"	187 lbs	082792
LSDC6124PA BC DU	1-4	DU	42"	187 lbs	082793



DC724 Series - Economy Surface Applied Multi-Sized Closers

- Fixed closing force with selectable sizes. Closing force setting is altered by changing the position of the closer on the door
- Adjustable closing and latch speeds
- Non-handed installation
- Supplied with parallel arm and mounting bracket
- Designed for light to medium traffic situations
- 5 year replacement warranty

Mfg#	Installed As Fin.	Size	Max. Door Width	Max. Door Wt.	EZ #
LSDC724PA AL	AL	2	33"	88 lbs	082785
LSDC724PA DU	DU	2	33"	88 lbs	082786
		3	37"	132 lbs	
		4	43"	176 lbs	



Sex Nut Bolts

Mfg # LSDCSEXNUTS
EZ # 082822



Display Board

Pin Tumbler Brass Padlocks

- Solid brass body, highly corrosion resistant • 2 nickel plated brass keys
- Pin tumbler cylinder with solid brass keyway • Double locking shackle
- Chrome plated hardened steel shackle • 6 per box, except BP200 (12)

Mfg #	Case Width	Shackle Dia.	Shackle Clear.
BP200	3/4"	1/8"	1/2"
BP300	1 1/4"	3/16"	5/8"
BP320	1 1/4"	3/16"	2 1/2"
BP400	1 1/2"	1/4"	13/16"
BP420	1 1/2"	1/4"	2 1/2"
BP450	1 3/4"	5/16"	7/8"
BP470	1 3/4"	5/16"	2 1/2"
BP500	2"	3/8"	1"
BP520	2"	3/8"	2 1/2"

Each lock
individually boxed

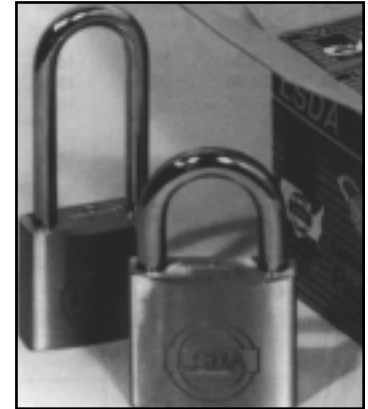

Mfg. #	EZ #	Keying
LSBP200C KD	025695	KD Carded
LSBP200KA600	025696	KA600
LSBP200KA601	025697	KA601
LSBP200KA602	025698	KA602
LSBP300C KD	025699	KD Carded
LSBP300KA700	025700	KA700
LSBP300KA701	025701	KA701
LSBP300KA702	025702	KA702
LSBP320KD	025706	KD
LSBP320KA700	025703	KA700
LSBP320KA701	025704	KA701
LSBP400C KD	025707	KD Carded
LSBP400KA800	025708	KA800
LSBP400KA801	025709	KA801
LSBP400KA802	025710	KA802
LSBP400KD MK	030023	KD & MK

Mfg. #	EZ #	Keying
LSBP420KD	025715	KD
LSBP420KA800	025712	KA800
LSBP420KA801	025713	KA801
LSBP420KA802	025714	KA802
LSBP450C KD	025716	KD Carded
LSBP450KA850	025717	KA850
LSBP450KA851	025718	KA851
LSBP450KA852	025719	KA852
LSBP450KD MK	030024	KD & MK
LSBP470KD	025724	KD
LSBP470KA850	025721	KA850
LSBP470KA851	025722	KA851
LSBP470KA852	025723	KA852

Mfg. #	EZ #	Keying
LSBP500C KD	025725	KD Carded
LSBP500KA900	025726	KA900
LSBP500KA901	025727	KA901
LSBP500KA902	025728	KA902

LSBP520KD	025732	KD
LSBP520KA900	025729	KA900
LSBP520KA901	025730	KA901

Keyblanks

LSDLDA 30	025739	Fits BP200
LSDLDA 31	025740	Fits BP300
LSDLDA 32	025741	Fits BP400
LSDLDA 33	025742	Fits BP450
LSDLDA 34	025743	Fits BP500

LSMASTER KEY	030038	Fits BP400
LSMASTERKEY	030039	Fits BP450

C - Carded **KD** - Keyed Differently
KA - Keyed Alike **MK** - Master Keyed

Shielded Disc Padlock

- 2 3/4" corrosion resistant stainless steel case
- Hardened steel deadbolt, double locking shackle
- Solid brass, anti-pick, pin tumbler brass cylinder
- M1 keyway

Mfg # LS2012 KA2359 EZ # 077158
Mf # LS2012 KA2396 EZ # 077159
Mfg # LS2012 KD EZ # 077160



LSDA Padlocks Display

- 1 Rekeyable Padlock
 - 5 different brass padlocks with markings showing both the long and short shackles
 - 4 different laminated padlocks
 - Literature Rack w/Literature
- Mfg # LSPBA EZ # 041164



Dial Combination Padlock

- 1 7/8" stainless steel case
- Resists corrosion
- Over 1,500 combinations
- Hardened chrome plated steel shackle

Mg # LS2021 EZ # 077161



Keyless Combination Padlocks

- Steel hardened shackle • Keyless security
- Brass body • Weatherproof
- Resettable combinations

Mfg. #	Shackle	EZ #
LSCP50B	1"	066203
LSCP52B	2"	066205





RK134 Series Rekeyable Brass Padlocks

Easy cylinder removal, with screwdriver or similar tool. Depress a single loaded pin. Cylinder may then be removed for replacement or rekeying. Non-key retaining padlocks have phillips head screw in place of pin.

- 1 3/4" solid brass body • High precision 6 pin brass cylinder • Shackle diameter: 5/16"
- Hardened steel double locking shackle • Steel shackle 1" clearance • Stocked 0-bitted
- Packed 6 per box • Key retaining and non-key retaining cylinders are not interchangeable



RK134 "Key Retaining"

Mfg #	Keyway	EZ #
LSRK134 100	Yale 8	009536
LSRK134 200	Kwikset	009538
LSRK134 300	Schlage C	009539
LSRK134 400	Corbin 60, 59A1, A2, B1, B2	009541
LSRK134 700	Sargent LA-LC	009544
LSRK134 800	Weiser	009545
LSRK134 900	Arrow	009546
LSRK134 1000	Russwin D1, D2, D3, D4	009537
LSRK134 3000	Schlage C-K	009540

RK134-1 "Non-Key Retaining"

Mfg #	Keyway	EZ #
LSRK134 1 100	Yale 8	009527
LSRK134 1 200	Kwikset	009529
LSRK134 1 300	Schlage C	009530
LSRK134 1 400	Corbin 60, 59A1, A2, B1, B2	009532
LSRK134 1 700	Sargent LA-LC	009533
LSRK134 1 800	Weiser	009534
LSRK134 1 900	Arrow	009535
LSRK134 1 1000	Russwin D1, D2, D3, D4	009528
LSRK134 1 3000	Schlage C-K	009531

Replacement Shackles

Mfg #	Desc.	EZ #	Mfg #	Desc.	EZ #	Mfg #	Desc.	EZ #
LS8001	1" Steel Shackle	069001	LS8004	4" Steel Shackle	009888	LS8005 4	4" Brass Shackle	009891
LS8002	2" Steel Shackle	009886	LS8005 2	2" Brass Shackle	009889			
LS8003	3" Steel Shackle	009887	LS8005 3	3" Brass Shackle	009890			

Replacement Shackles also work on Abus 83/45 Z-Bar

RK450 Series Rekeyable Brass Padlocks

- 1-3/4" solid brass corrosion-resistant body. • Case-hardened chrome plated double ball locking shackle.
- Patent Pending quick-change shackle feature. • 1-3/16" standard shackle length with options for 2" or 3" lengths.
- Standard non-key retaining cylinders may be easily converted to key-retaining function by adding pin #LS9008

Padlock Without Cylinder: Mfg # LSRK450 EZ # 077059

Mfg #	Cylinder Keyway	EZ #	Mfg #	Cylinder Keyway	EZ #
LSRKC100	Yale 8 (Y1)	077060	LSRKC700	Sargent - LA-LC	077064
LSRKC200	Kwikset (KW1)	077061	LSRKC800	Weiser (WR5)	077065
LSRKC300	Schlage C (SC1)	077062	LSRKC900	Arrow (AR1)	077066
LSRKC400	Corbin: 60, 59A1, A2, B1, B2	077063	LSRKC1000	Russwin (D1, D2, D3, D4)	077067
			LSRKC3000	Schlage (C-K)	077068

Accessories

Mfg #	Desc.	EZ #
LS450 KIT	Adaptor / driver / retain pin	084397
LS9006	RC450 Adapter - accepts LSDA C500, Schlage 21-002, Assa 65611, Kaba 3400 x 1099 cyl.	077188
LS9007	Driver- use w/ adapter above	077189
LS9008	Pin f/ key-retaining function	077399
LS901 00001	Screw Pack	082578



NOTE: RC450 accepts Medeco cylinder 20-200L if used with Master padlock driver #0298-0627

Shackleless High Security Padlock

- 2-7/8" diameter solid chrome plated steel body • Removable cylinder for easy rekeying • AM3 keyway
- Pin tumbler solid brass cylinder • Shackleless rear locking bolt for maximum security

Mfg # LS2035 KA523647	EZ # 077168	
Mfg # LS2035 KD	EZ # 077170	Hasp: Mfg # LS2037 EZ # 077171
Mfg # LS2035 KA642586	EZ # 077169	

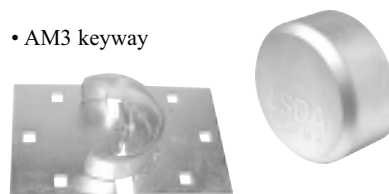



Pin Tumbler Laminated Padlocks

- Each lamination is riveted solid and is individually rust proofed for longer life • Zinc plated galvanized laminates
- Resilient bumpers keep padlocks from marring or scratching
- Chrome plated hardened steel shackle
- Double steel ball locking security • 2 nickel plated brass keys
- Pin tumbler solid brass cylinders • Each lock individually boxed
- Packed 6 per box, except LP30 which is Packed 12 per box

Mfg. #	Case Width	Shackle Dia.	Shackle Clear.
LP30	1 1/4"	3/16"	5/8"
LP40	1 1/2"	1/4"	13/16"
LP50	1 3/4"	5/16"	15/16"
LP60	2"	3/8"	1 1/16"

Mfg. #	Keying	EZ #	Mfg. #	Keying	EZ #
LSLP30KD	KD	009222	LSLP50C KD	KD Carded	025736
LSLP30C KD	KD Carded	025733	LSLP50KA FEO374	KA	009233
LSLP30KA LN0019	KA	009214	LSLP50KA FEO587	KA	009234
LSLP30KA LN0024	KA	009215	LSLP50KA FEO685	KA	009235
LSLP30KA LN0038	KA	009216	LSLP50KA FE1200	KA	009236
LSLP30KA LN0040	KA	009217	LSLP50KA FE1202	KA	009237
LSLP30KA LN0044	KA	009218	LSLP60KD	KD	009244
LSLP30KA LN0045	KA	009219	LSLP60CKD	KD Carded	025738
LSLP40KD	KD	009232	LSLP60KA FEO587	KA	009242
LSLP40KA FEO371	KA	009223	LSLP60KA FE1226	KA	009243
LSLP40KA FEO587	KA	009224			
LSLP40KA FEO597	KA	009225	Key Blanks		
LSLP40KA FEO599	KA	009226	LSDLSDA3	Fits LP30	009255
LSLP40KA FEO691	KA	009227	LSDLSDA4	Fits LP40-60	009256
LSLP50KD	KD	009241			



C = Carded

Weather Proof Pin Tumbler Padlocks

- Case hardened chrome plated steel double locking shackle • Case width: 2"
- Thermoplastic weatherproof jacket • Shackle O ring seals out moisture and dirt
- Pin tumbler solid brass cylinder • Perfect for harsh weather conditions

Mfg #	EZ #	Shackle	Mfg #	EZ #	Shackle
LSWP40 KA 2126	077162	1 1/4"	LSWP42 KA 2126	077165	2"
LSWP40 KA 2258	077163	1 1/4"	LSWP42 KA 2258	077166	2"
LSWP40 KD	077164	1 1/4"	LSWP42 KD	077167	2"



Solid Body Padlocks

- Interchangeable and rekeyable cylinders • Solid brass cylinders for superior resistance to corrosion
- One key can work the entire series of heavy duty padlocks • AM3 keyway
- Standard non-key retaining cylinders are easily converted to key-retaining function by adding pin #LS9008
- Quick-change shackles give you the versatility to easily change shackle lengths
- Double ball locking hardened steel shackles offer superior resistance • 1" shackle clearance

Mfg #	EZ #	Description
LSAR400	077172	1 1/2" aluminum body w/o cyl.
LSBR400	077173	1 1/2" brass body w/o cyl
LSBR450	077174	1 3/4" brass body w/o cyl
LSSR400	077175	1 1/2" steel body w/o cyl
LSSR450	077176	1 3/4" steel body w/o cyl
LSSR500	077177	2" steel body w/o cyl.
LSCR600	077178	2 1/4" chrome plated steel w/o cyl
LSCR620	077179	2 1/4" chrome plated steel w/2 3/8" shackle - w/o cyl
RC10 KA24536	077180	Cylinder: 5-pinned / drilled 6
RC10 KA35624	077181	Cylinder: 5-pinned / drilled 6
RC10 KA52314	077182	Cylinder: 5-pinned / drilled 6
RC10 KD	077183	Cylinder: 5-pinned / drilled 6

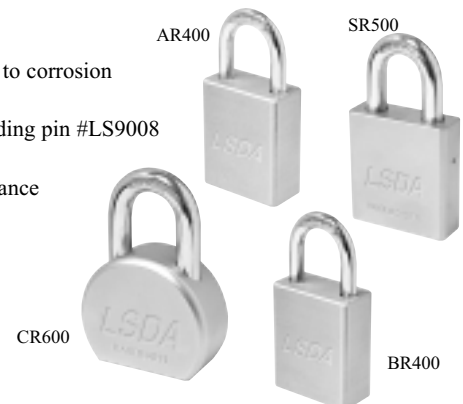

Mfg. #	EZ#	Shackles
LS9000	077184	1 1/2" for 1 1/2" padlock (R400)
LS9001	077185	3" for 1 1/2" padlock (R400)
LS9002	077069	2" for 1 3/4" padlock (R450)
LS9003	077070	3" for 1 3/4" padlock (R450)
LS9004	077186	2" for 2" padlock (R500)
LS9005	077187	3" for 2" padlock (R500)



Universal Tubular Cam Locks

UTCL38

Cylinder Length: 3/8"
Max. Thickness: 1/4"

Mfg#	EZ #
LSUTCL38KD	009654
LSUTCL38KA56804	009650
LSUTCL38KA56808	041176
LSUTCL38KA56809	041177
LSUTCL38KA56812	009651
LSUTCL38KA56817	041178

UTCL58

Cylinder Length: 5/8"
Max. Thickness: 1/2"

Mfg#	EZ #
LSUTCL58KD	009660
LSUTCL58KA56800	009655
LSUTCL58KA56801	009656
LSUTCL58KA 56804	009657
LSUTCL58KA56812	009658
LSUTCL58KA56813	041179

UTCL78

Cylinder Length: 7/8"
Max. Thickness: 3/4"

Mfg#	EZ #
LSUTCL78KD	009667
LSUTCL78KA56802	041180
LSUTCL78KA56803	041181
LSUTCL78KA56804	009663
LSUTCL78KA56812	009664
LSUTCL78KA56814	041182



UTCL118

Cylinder Length: 1 1/8"
Max. Thickness: 1"

Mfg#	EZ #
LSUTCL118KD	009647
LSUTCL118KA56804	009644
LSUTCL118KA56805	041183
LSUTCL118KA56812	009645
LSUTCL118KA56815	041184

UTCL112

Cylinder Length: 1 1/2"
Max. Thickness: 1 1/8"

Mfg#	EZ #
LSUTCL112KD	009641
LSUTCL112KA56804	009638
LSUTCL112KA56806	041185
LSUTCL112KA56807	041186
LSUTCL112KA56812	009639
LSUTCL112KA56816	041187

Each Lock Provides Six Different Functions				
Func.	Key Rotation from 12 o'clock Position To:	Key Removable at:	Use Cam Stop	Insert Spline Filler at:
1	3 o'clock	12 only	90° right	3 o'clock
2	3 o'clock	12 and 3	90° right	none
3	6 o'clock(right)	12 and 6	180° right	3 o'clock
4	9 o'clock	12 only	90° left	9 o'clock
5	9 o'clock	12 and 9	90° left	none
6	6 o'clock(left)	12 and 6	180° left	9 o'clock

Disc Tumbler Cam Locks

CL38

Cylinder Length: 3/8"
Max. Thickness: 3/16"

Mfg#	EZ #
LSCL38KD	009024
LSCL38KA300	009017
LSCL38KA301	009018
LSCL38KA302	009019
LSCL38KA303	009020
LSCL38KA304	009021
LSCL38KA305	009022
LSCL38KA306	009023

CL58

Cylinder Length: 5/8"
Max. Thickness: 5/16"

Mfg#	EZ #
LSCL58KD	009032
LSCL58KA300	009025
LSCL58KA301	009026
LSCL58KA302	009027
LSCL58KA303	009028
LSCL58KA304	009029
LSCL58KA305	009030
LSCL58KA306	009031

CL78

Cylinder Length: 7/8"
Max. Thickness: 9/16"

Mfg#	EZ #
LSCL78KD	009040
LSCL78KA300	009033
LSCL78KA301	009034
LSCL78KA302	009035
LSCL78KA303	009036
LSCL78KA304	009037
LSCL78KA305	009038
LSCL78KA306	009039

CL118

Cylinder Length: 1 1/8"
Max. Thickness: 13/16"

Mfg#	EZ #
LSCL118KD	009008
LSCL118KA300	009001
LSCL118KA301	009002
LSCL118KA302	009003
LSCL118KA303	009004
LSCL118KA304	009005
LSCL118KA305	009006
LSCL118KA306	009007

CL138

Cylinder Length: 1 3/8"
Max. Thickness: 1 1/16"

Mfg#	EZ #
LSCL138KD	009016
LSCL138KA300	009009
LSCL138KA301	030265
LSCL138KA302	009011
LSCL138KA303	009012
LSCL138KA304	009013
LSCL138KA305	009014
LSCL138KA306	009015

CL134

Cylinder Length: 1 3/4"
Max. Thickness: 1 7/16"

Mfg#	EZ #
LSCL134KD	041174
LSCL134KA300	041166
LSCL134KA301	041167
LSCL134KA302	041168

- 3/4" diameter
- Polished nickel
- Disc tumbler
- 90° & 180° cam turn
- Key removable in both locked and unlocked positions

Each Cam lock includes:
Finish washer
Spur washer
3/4" nut
90° & 180° stop washer
Straight & Offset cam



Single Bitted Showcase Locks

Mfg#	Finish	Keying	EZ #
LSSC23KA LS300	26D	KA	060259
LSSC23KA LS301	26D	KA	060260
LSSC23KD	26D	KD	060261



Mortise, Rim, Thumbturn & Dummy Cylinders



Mortise Cylinders

- Stocked with Adams Rite cam • Made in the USA • Solid Brass Bar Stock Cylinder and Plug
- 1" 5 pin only, 1 1/8" & 1 1/4" keyed 5 pin, drilled to accept 6 pin • Furnished with two look-alike keys

1" Mortise Cylinders

Mfg. #	EZ #
<i>Arrow Kwy.</i>	
LSM1002AW26D	009422
LSM1002AW13	009424
<i>Corbin 60 Kwy</i>	
LSM1002C60 3	027765
LSM1002C60 26D	009427
<i>Composite</i>	
LSM1002COMP13	029266
LSM1002COMP26D	009425
<i>Kwikset</i>	
LSM1002KW3	009432
LSM1002KW5	070443
LSM1002KW13	009433
LSM1002KW26D	009431
<i>LSA</i>	
LSM1002LSA13	074691
LSM1002LSA26D	074692
<i>Russwin D1</i>	
LSM1002RD1 3	027776
LSM1002RD1 13	009438
LSM1002RD1 26D	009437
<i>Sargent LA</i>	
LSM1002LA13	028385
LSM1002LA26D	009446
<i>Schlage C</i>	
LSM1002SCC3	009441
LSM1002SCC13	009442
LSM1002SCC26D	009440
<i>Schlage E</i>	
LSM1002SCE3	045365
LSM1002SCE13	041148
LSM1002SCE26D	027767
<i>Schlage C-K</i>	
LSM1002SCK3	009444
LSM1002SCK13	009445
LSM1002SCK26D	026849
<i>Weiser</i>	
LSM1002WE3	009448
LSM1002WE13	009449
LSM1002WE26D	009447
<i>Yale 8</i>	
LSM1002YA3	009451
LSM1002YA13	009452
LSM1002YA26D	009450

1 1/8" Mortise Cylinders

<i>Arrow Kwy</i>	
LSM1181AW3	009474
LSM1181AW26D	009473

1 1/8" Mortise Cylinders

Mfg. #	EZ #
<i>Corbin 60</i>	
LSM1181C60 26D	009478
<i>Composite</i>	
LSM1181COMP13	009477
<i>Kwikset</i>	
LSM1181KW3	009481
LSM1181KW13	041151
LSM1181KW26D	009480
<i>LSA</i>	
LSM1181LSA3	009485
LSM1181LSA13	009486
LSM1181LSA26D	009484
<i>Russwin D1</i>	
LSM1181RD1 3	027787
LSM1181RD1 26	071317
LSM1181RD1 13	041153
LSM1181RD1 26D	009487
<i>Russwin 981</i>	
LSM1181R981 26D	045376
<i>Sargent LA</i>	
LSM1181LA3	009488
LSM1181LA13	028386
LSM1181LA26D	009494
<i>Schlage C</i>	
LSM1181SCC3	009490
LSM1181SCC13	029315
LSM1181SCC26D	026852
<i>Schlage C-K</i>	
LSM1181SCK3	009492
LSM1181SCK13	041154
LSM1181SCK26D	009491
<i>Sargent RA-RC</i>	
LSM1181RAC 26D	069869
<i>Weiser</i>	
LSM1181WE3	009496
LSM1181WE5	070460
LSM1181WE13	036016
LSM1181WE26	071315
LSM1181WE26D	009495
<i>Yale 8</i>	
LSM1181YA3	009498
LSM1181YA13	041155
LSM1181YA26D	009497

1 1/4" Mortise Cylinders

<i>Corbin 60</i>	
LSM1141C60 3	027768
LSM1141C60 26D	027769

1 1/4" Mortise Cylinders

Mfg. #	EZ #
<i>Kwikset</i>	
LSM1141KW3	009458
LSM1141KW26D	009457
<i>Lockwood</i>	
LSM1141LO3	041149
<i>LSA</i>	
LSM1141LSA3	009460
LSM1141LSA26D	009459
LSM1141LSA13	029292
<i>Russwin D1</i>	
LSM1141RD1 3	009462
<i>Schlage C</i>	
LSM1141SCC3	009465
LSM1141SCC26D	009464
<i>Schlage C-K</i>	
LSM1141SCK3	009467
LSM1141SCK26D	009466
<i>Yale 8</i>	
LSM1141YA3	009472
LSM1141YA26D	009471

Rim Cylinders

<i>Arrow</i>	
LSR200AW 3	009582
LSR200AW 26D	009581
LSR200AW 13	027789
<i>Corbin 60</i>	
LSR200C60 3	027790
LSR200C60 26D	009585
LSR200C60 13	045378
<i>Dexter</i>	
LSR200DX 3	026853
<i>Kwikset</i>	
LSR200KW 3	009587
LSR200KW 26D	009586
LSR200KW 13	027793
<i>Lockwood</i>	
LSR200LO 3	041157
LSR200LO 26D	041158
<i>LSA</i>	
LSR200LSA 3	009589
LSR200LSA 26D	009588
LSR200LSA 13	009590
<i>Russwin D1</i>	
LSR200RD1 3	009592
LSR200RD1 26D	009591
LSR200RD1 13	027794

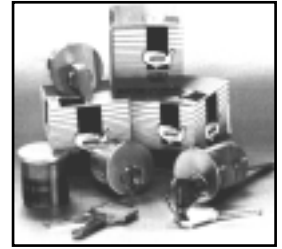

Mfg. #	EZ #
<i>Russwin 981</i>	
LSR200 R981 26D	041159
<i>Sargent</i>	
LSR200LA 3	009593
LSR200LA 26D	009600
<i>Schlage C</i>	
LSR200SCC 3	009595
LSR200SCC 26D	009594
LSR200SCC 13	009596
<i>Schlage E</i>	
LSR200SCE 26D	027796
<i>Schlage C-K</i>	
LSR200SCK 3	009598
LSR200SCK 26D	009597
LSR200SCK 13	009599
<i>Weiser</i>	
LSR200WE 3	009602
LSR200WE 26D	009601
LSR200WE 13	027774
<i>Yale 8</i>	
LSR200YA 3	009604
LSR200YA 26D	009603
LSR200YA 13	009605
<i>Mortise Thumbturn Cylinders</i>	
LST1002 3	009628
LST1002 26D	009627
LST1002 13	009629
LST1181 3	009633
LST1181 26D	009632
LST1181 13	009634
LST1141 3	009631
LST1141 26D	009630
<i>Mortise Dummy Cylinders</i>	
LSD1002 3	009076
LSD1002 26D	009075
LSD1002 13	009077
LSD1181 3	041143
LSD1181 26D	041144

LSM - Keyed Mort. Cyl.
1002 - 1" Cylinder
1181 - 1 1/8" Cylinder
1141 - 1 1/4" Cylinder



Key-N-Knob & Deadbolt Cylinders

Cylinder Accessories • Key Blanks

Universal Combination Cylinders

- Operates most Grade 1 & 2 locksets and leversets including: Arrow B & D knobs, plus Arrow D, E, K, Schlage B160P, B200 and H series deadlocks
- One piece OEM quality tailpieces • Drilled 6, pinned 5 standard • Manufactured from solid brass
- Repinnable into all OEM systems including Grand Master Keying • Made in the USA



Mfg #	Keyway	EZ #	Mfg #	Keyway	EZ #	Mfg #	Keyway	EZ #
LSC500AW3	Arrow	076147	LSC500LSA3	LSA	076159	LSC500SCC26D	Schlage C	076165
LSC500AW 26D	Arrow	076148	LSC500LSA26D	LSA	076160	LSC500SCE26D	Schlage E	076167
LSC500CO3	Composite	076149	LSC500RD1 3	Russwin D1	076161	LSC500SCK3	Schlage C-K	076168
LSC500CO26D	Composite	076150	LSC500RD1 26D	Russwin D1	076162	LSC500SCK26D	Schlage C-K	076169
LSC500C60 3	Corbin 60	076151	LSC500R981 26D	Russwin 981	076163	LSC500WE3	Weiser	076170
LSC500C60 26D	Corbin 60	076152	LSC500LA3	Sargent LA	076157	LSC500WE26D	Weiser	076171
LSC500KW3	Kwikset	076155	LSC500LA26d	Sargent LA	076158	LSC500YA3	Yale 8	076172
LSC500KW26D	Kwikset	076156	LSC500SCC3	Schlage C	076164	LSC500YA26D	Yale 8	076173

Key In Knob Or Lever Cylinders

Will fit: LSDA Grades 1 & 2, Arrow M & H Series, Schlage A & D Series, American 3600 Series padlocks & more!

Mfg. #	Keyway	EZ #	Mfg. #	Keyway	EZ #
LSK300AW3	Arrow	009126	LSK300LSA3	LSA	009142
LSK300AW26D	Arrow	009125	LSK300LSA26D	LSA	009141
LSK300COMP26D	Composite	009127	LSK300RD1 26D	Russwin D1	009143
LSK300C60 3	Corbin 60	009130	LSK300R981 26D	Russwin 981	009145
LSK300C60 26D	Corbin 60	009129	LSK300SCC26D	Schlage C	009147
LSK300C59 A1	Corbin 59 A1	069868	LSK300SCE26D	Schlage E	009149
LSK300KW3	Kwikset	009138	LSK300SCK3	Schlage C-K	009152
LSK300KW26D	Kwikset	009137	LSK300SCK26D	Schlage C-K	009151
LSK300LA26D	Sargent LA	009155	LSK300WE3	Weiser	009158
LSK300LO3	Lockwood	009140	LSK300WE26D	Weiser	009157
LSK300LO26D	Lockwood	009139	LSK300YA3	Yale 8	009160
			LSK300YA26D	Yale 8	009159



IC Core Cylinders

Mfg #	Kwy	EZ #
KS206LSX26D	LSX	060250
KS206LSX4	LSX	060249

Cams

Mfg#	Desc.	EZ #
IL863 00 10	Yale	007437
IL863G 00 10	New Standard	030342
IL863D 00 10	Cloverleaf	026455
IL863A 00 10	Adams Rite	007194
IL863E 00 10	Narrow	007440

Wafers

Mfg#	Desc.	EZ #	Mfg#	Desc.	EZ #
FODT 23001	#1	074535	FODT 23005	#5	074539
FODT 23002	#2	074536	FODT 23006	#6	074540
FODT 23003	#3	074537			
FODT 23004	#4	074538			



Neuter Bow Key Blanks "NB"

- Lacquered brass blanks.
- Embossed face.
- Meets Original manufacturers tolerances.
- One side plain.
- Made in the USA.



Unidentifiable to the untrained eye

Mfg#	Original Mfg #	EZ #
LS999 NB	Yale 8	025992
LS01007LA NB	Sargent 6275LA	009702
LSA1011D1 NB	Russwin 6D1R	008878
LS1054WB NB	Weiser 1555	009747
LSD1054K NB	Dexter 67	009078
LSD1054K NB DND	Dexter 67 (Do Not Duplicate)	062139
LS1145NB	Schlage 35-100C	009766
LS1145A NB	Schlage 35-101C	009767
LSA1145E NB	Schlage 35-101E	008879
LS1176NB	Kwikset 1063	009773



Look-Alike Key Blanks

Mfg. #	Mat	Original	EZ #	Mfg. #	Mat	Original	EZ #
GN1063	NP	1063 Kwikset	004441	GN275LA	NS	275LA Sargent	004471
GN1K	BR	1K Master	004434	GN5D1R	NS	5D1R Russwin	004480
GNP1555NS	NP	1555 Weiser (Sq head)	025990	GN6D1R	NS	6D1R Russwin	004485
GN12344	BR	12344 Weslock	004444	GN6275LA	NS	6275LA Sargent	004486
GN8	BR	Yale 8 (round)	004414	<i>Automotive</i>			
GNE8	BR	Yale 8 (Sq head)	004195	GNS69CH	NP	Chrysler Secondary	025996
GN100C NS	NS	35-100-C Schlage	004436	GN70CH	NP	Chrysler Primary	025997
GN100E NS	NS	35-100-E Schlage	004437	GN70AM	NP	Amer. Motors Primary	040086
GN101C NS	NS	35-101-C Schlage	025987	GNP98A	NP	GM A Primary	025998
GN101E NS	NS	35-101-E Schlage	004439	GNP98C	NP	GM C Primary	025999
GN101EF NS NS	NS	35-101-E-F Schlage	025989	GNP98E	NP	GM E Primary	026000
GN101F NS	NS	35-101-F Schlage	004440	GNP98J	NP	GM J Primary	026001
GN1A1A1	NS	1A1A1 Best	004421	GNS98B	NP	GM B Secondary	026002
GN1A1B1	NS	1A1B1 Best	004422	GNS98D	NP	GM D Secondary	026003
GN1A1C1	NS	1A1C1 Best	004423	GNS98H	NP	GM H Secondary	026004
GN1A1D1	NS	1A1D1 Best	004424	GNS98K	NP	GM K Secondary	026005
GN1A1E1	NS	1A1E1 Best	004425	LSB86GP	NS	GM Dble Side G	076254
GN1A1F1	NS	1A1F1 Best	004427	LSB89GP	NS	GM Dble Side J&N	076255
GN1A1G1	NS	1A1G1 Best	004428	LSY157CHY	NS	Chrysler P1794	076259
GN1A1H1	NS	1A1H1 Best	004429	GN83FD	NP	Ford Prim. 67&Up	025993
GN1A1J1	NS	1A1J1 Best	004430	GNS83FD	NP	Ford Sec. 67&Up	025994
GN1A1K1	NS	1A1K1 Best	004431	GN84FD	NP	Ford Prim. 84 1/2	025995
GN1A1L1	NS	1A1L1 Best	004432	LSH54F	NS	Ford 1184FD	076258
GN1A1M1	NS	1A1M1 Best	004433	LSH67F	NS	Ford 10 cut 94-96	076256
GNZ1 60 6	NS	Z1-60-6 Corbin	004417	LSH75F	NS	Ford 8 cut w/o trans	076257



Made of the same materials as the originals

Packed 50 per box

Materials
BR - Brass
NP - Nickel Plated
NS - Nickel Silver

Brass Key Blanks

Mfg. #	Ilco #	EZ #	Mfg #	Ilco #	EZ #	Mfg#	Ilco#	EZ #
LSAM3	1045	008873	LSFA3	A1054WD	076246	LSRO3	1069N	009547
LSAP1	KP1/101AM	076240	LSHR1	1014C	009104	LSRU4	1011P	009578
LSAP2	KP2/102AM	076241	LSH50	S1167FD	009115	LSRU45	1011D1	009579
LSAP3	KP3/103AM	076242	LSH51	1167FD	009116	LSRU46	A1011D1	009580
LSAP4	KP4/104AM	076243	LSH54	1184FD	076247	LSSC1	1145	009609
LSAR1	1179	008874	LSH60	1190LN	076248	LSSC4	1145A	009611
LSAR4	1179A	008875	LSH67	1193FD	076249	LSSC8	1145E	009613
LSA1011 L4	Corbin L4	076435	LSH75	1196FD	076250	LSSC9	A1145E	009614
LSB1	1098M	008937	LSIN3	X1054K	040083	LSSE1	1022	009616
LSB01	R1003	008882	LSIN8	L1054B	009120	LSWK2	1175N	009669
LSB44	P1098E	008981	LSIN33	1054MT	009119	LSWR3	1054WB	009671
LSB45	S1098H	008982	LSKW1	1176	009124	LSWR5	N1054WB	009673
LSB46	P1098J	008983	LSKW10	A1176ST	076251	LSY1	999	009676
LSB47	S1098K	008984	LSL1	1004	009304	LSY1E	999N	009677
LSB48	P1098A	008985	LSLSDA9	1176	028084	LSY2	999A	009684
LSB49	S1098B	008986	LSLSDA10C	1145A	027983	LSY4	998	009686
LSB50	P1098C	008987	LSLSDA15	LSA 5 pin	074693	LSY6	997X	009687
LSB51	S1098D	008988	LSLSDA20	LSA 6 pin	009252	LSY11	O1122	009678
LSB86	B86 GM 95	076244	LSM1	1092	009420	LSY12	O1122A	009679
LSB89	B89 GM 95	076245	LSM2	1092B	009500	LSY13	O1122R	009680
LSCG1	1041G	008994	LSM10	1092N	009421	LSY14	O1122AR	009681
LSCG16	1041T	008995	LSNA6	R1064D	009504	LSY152	1770CH	009683
LSCO87	1001EH	009043	LSNA12	1069LA	009503	LS1137B	1137B	009765
LSCO88	A1001EH	009044	LSNA14	1069L	076252	LSY157	P1974	076253
LSCO106	1003M	009041	LSRA3	S1970AM	009520			
LSDE6	D1054K	009069	LSRA4	1970AM	009521			



- Tarnish resistant lacquer finish
- Both Ilco and Curtis numbers appear on blank
- One side blank for stamping
- Made in the U.S.A.
- Packed 50 per box



LSDA 911 Series offer an economical solution for many exit hardware needs. The low profile, modern pushbar design is suitable for most installations where cost is a factor and finish requirements are flexible. It is unique in its price range, with a full compliment of trim.

- Reversibility: Rim devices are non-handed. Vertical rod devices are field reversible.
- Function: Devices have all functions built in. Order trim with the device, or add it later.
- 161 Cutout: Covers stock hollow metal cutout. Control trim requires cover plate.
- Narrow Stile Aluminum Doors: Can be retro-fitted over Jackson and Dor-O-Matic Preparation. 48" must be used for 3'0" narrow stile aluminum door applications
- Strikes: All strikes are surface applied, except 2130 flush floor strike. PD911Rx48" supplied with 565 strike. PD911R x 36" supplied with 560 strike. (Refer to Monarch section)
- Latchbolts: 3/4" throw • Dogging: Half turn cam. • Doors: 1 3/4" thick standard.
- Mounting Height: 40 5/8" from center of latch to finished floor recommended.
- Sizes: 36" = 2'5" to 3'0"; 48" = 2'11" to 4'0". Cut to size in the field • Painted Finishes: AL Aluminum, BR Dark Bronze
- Projection: 2 1/2" maximum. 1 1/8" depressed. • ANSI: Certified ANSI A 156.3-1984 Grade 1 standards.



PD911V

Mfg#	Size	Finish	EZ #
LSPD911V 36AL	36"	AL	009512
LSPD911V 36BR	36"	BR	009513
LSPD911V 48AL	48"	AL	009514
LSPD911V 48BR	48"	BR	036042

PD911R

Mfg#	Size	Finish	EZ #
LSPD911R 36AL	36"	AL	009508
LSPD911R 36BR	36"	BR	009509
LSPD911R 48AL	48"	AL	041204
LSPD911R 48BR	48"	BR	009511

Made in the USA

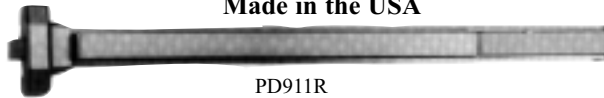

Panic Exit Device Trim

Mfg#	Desc.	Finish	EZ #
LSKIK 26D	Key in Knob Trim	26D	036043
LSNLP1905MAL	Pull Plate Trim	AL	009795
LSNLP1905M13	Pull Plate Trim	BR	009796
LST1906MAL	Thumb Contol	AL	009797
LST1906M13	Thumb Contol	BR	009798
LSK1907MAL	Knob Control	AL	009799
LSK1907M13	Knob Control	BR	009800
LSP1909MAL	Pull Control	AL	009801
LSP1909M13	Pull Control	BR	009802

PD911R

Mfg#	Desc.	Finish	EZ #
LS1910MAL LH	Lever Control	AL	041205
LS1910MAL RH	Lever Control	AL	041206
LS1910M13 LH	Lever Control	BR	009806
LS1910M13 RH	Lever Control	BR	041207
MN2000KD MAL	Key in Lever	AL	072793
MN2402KIL NL MAL	Night Latch Knob	26D	077404
MN2412KIL NL MAL	Night Latch Lever	32D	077405
MN4167MAL	Cover Plate	AL	011122
MN4168 32D	Plate F/BA Device	26D	041641

Exit Alarm Kit

When the touchbar is depressed, the horn sounds and the LED lights up to signal that the opening has been trespassed.

Mfg # MNEAK MAL EZ# 009084

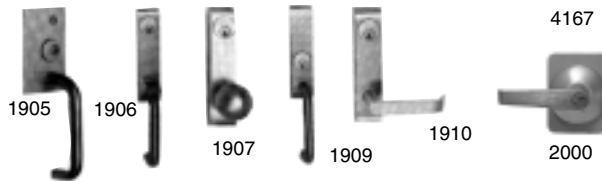

LSDA 1 Hour Fire Safes

- Attractive high gloss white color • Pre-drilled and capped bolt down hole
- Resettable electronic combination lock with flip-top cover
- 2 heavy duty throw bolts & hinge side protected with an interlocking bolt
- Plastic slide tray to hold small misc. valuables • Chrome color hinge caps

Mfg #	Inside	Outside	Wt	EZ#
LSEH613	5 5/8" x 13" x 8 3/4"	9 3/4" x 17 1/2" x 13 3/4"	64	077532
LSEH1015	9 7/8" x 15 3/8" x 11 1/2"	14 1/8" x 20" x 16 1/2"	103	077533
LSEH1510	15 1/2" x 9 7/8" x 11 1/2"	19 1/2" x 14 1/2" x 16 1/2"	103	077534





Key Caps

Rubber-like vinyl key caps. Stretches to fit over round-headed keys. Assorted colors.

Mfg # LU16500 200/display box EZ # 026861

Mfg # LU16504 4/cd./asst. EZ # 009978

Mfg # LU16506 4/cd./neon EZ # 028428



Key Caps For GM Keys

Sturdy vinyl, will fit over GM key head shapes. Available in red, black, dark blue and gray.

Mfg # LU17120 50 ea. (sq. black) EZ # 041211

Mfg # LU17135 50 ea. (sq. dk. blue) EZ # 041212

Mfg # LU17170 50 ea. (sq. red) EZ # 041213

Mfg # LU17192 50 ea. (sq. gray) EZ # 041214

Mfg # LU17220 50 ea. (rd. black) EZ # 041215

Mfg # LU17235 50 ea. (rd. dk. blue) EZ # 041216

Mfg # LU17270 50 ea. (rd. red) EZ # 041217

Mfg # LU17292 50 ea. (rd. gray) EZ # 041218

Mfg # LU17315 150/box EZ # 077761

Solid Brass Key Tags

Can be stamped or engraved. .040" thick. Ideal for pet tags, long term site I.D. or industrial applications.

Mfg # LU26010 1" 100/Box EZ # 028132

Mfg # LU26012 1 1/4" 100/Box EZ # 028134

Mfg # LU26013 1 3/8" 100/Box EZ # 028135

Mfg # LU26512 1 1/4" 5/cd. EZ # 075600



Paper Tags With String

Ideal for identifying prices, sizes, etc. Sturdy white paper stock & metal rim offers added strength.

Mfg # LU27000 15/16" 100/Box EZ # 041219

Mfg # LU27200 1 1/4" 100/Box EZ # 041220

Mfg # LU27400 1 9/16" 100/Box EZ # 041221



Paper Tags With Ring

Supplied with overlapping ring, sturdy metal rimmed white paper tags. Ideal for price & key tags.

Mfg # LU28000 15/16" 50/Box EZ # 069566

Mfg # LU28200 1 1/4" 50/Box EZ # 045426

Mfg # LU28229 1 1/4" 25/Box EZ # 071019

Mfg # LU28400 1 9/16" 50/Box EZ # 045427



Paper Tags With Clip

Supplied with metal clip, sturdy metal rimmed white paper tags. Ideal for price & key tags.

Mfg # LU29200 1 1/4" 50/Box EZ # 045428



Aluminum Tag

Color-coded tags, can be stamped or engraved. Available in black, blue, purple, red, aluminum.

Mfg # LU25605 1 1/4" 5/cd. EZ # 075576



Identification Key Tags

Key Tag With Ball Chain

Transparent tag 15/16" x 2 1/4" comes in six assorted colors (clear, blue, green, red, orange and yellow) with paper inserts.

Mfg # LU10100 100/display box EZ # 026865

Mfg # LU10102 5/pkg (2 per cd) EZ # 009974



Large Key Tag With Ball Chain

Tag measures 1 1/4" x 3". Paper insert slides out for easy writing. Tough propionate resists breakage. Clear tag with assorted color inserts.

Mfg # LU90101 5/pkg (2 per cd) EZ # 029442



Key Tag With Ring

Ultra flexible with 3/4" over-lapping key ring. 6 solid colors (red, yellow, green, blue, purple, black).

Mfg # LU16900 200/display box EZ # 028434



Key Tag With Swivel & Ring

Ultra flexible with metal swivel ring. 6 solid colors (red, yellow, green, blue, purple, black). Tag measures: 7/8" x 2".

Mfg # LU16800 200/display box EZ # 026864

Mfg # LU16802 5/pkg (2 per cd)/asst. EZ # 009980

Mfg # LU16827 160/jar EZ # 072675



Key Tag With Split Ring

Transparent tag 1 1/8" x 2 1/4". 7/8" nickel plated tempered steel split key ring.

Mfg # LU20402 5/pkg (2 per cd) EZ # 009984



Key Tag With Split Ring

Tag measures 1 1/8" x 2 1/4" and has an open close flap for adding identification. 8 assorted colors: (clear, blue, orange, green, red, yellow, purple and magenta).

Mfg # LU60500 100/display box EZ # 026871

Mfg # LU60502 5/pkg (2 per cd) EZ # 010029



Key Tag With Tang Ring

Compact tag 15/16" x 2 1/4", 1" tang ring. 8 assorted colors (clear, blue, orange, green, red, yellow, purple and magenta), with paper inserts.

Mfg # LU12300 100/display box/asst. EZ # 009975

Mfg # LU12302 5/pkg (2 per cd) EZ # 009977

Mfg # LU12300 100 100/display box/clear EZ # 084832





Key Tag Racks

4 Keytag Rack

Size: 5" x 2 1/2" x 1/2"

Mfg # LU60540 EZ # 010031



6 Keytag Rack

Size: 8" x 2 3/4" x 1/2"

Mfg # LU60562 EZ # 080899

8 Keytag Rack Size: 10" x 2 1/2" x 1/2"

Mfg # LU60580 EZ # 010028

Key Organizer

Rugged polypropylene cabinet. Supplied with mounting screws.



8 1/2" x 10 1/2" / 24 hooks

Mfg # LU61000 EZ# 068238

Mfg # LU61200 EZ# 069918 (Locking)

16" x 19" / 72 hooks

Mfg # LU61600 EZ# 077134



16" x 19" / 216 hooks

Mfg # LU61800 EZ# 077135

Metal Key Clips

Bolt Snap

Loop rotates 360°. Measures 3" without the 1 1/8" split key ring.

Available in solid brass with a solid brass split key ring (#50).



Mfg # LU45001 1/card (brass) EZ # 029440

Mfg # LU45012 12/card (brass) EZ # 041243

Mfg # LU45112 12/card (nickel) EZ # 026869

Mfg # LU45101 5 pk (nickel) EZ # 062187

Small Bolt Snap

Loop rotates 360°. Measures 2 1/8" without 7/8" split key ring.



Mfg # LU44501 1/card (nickel) EZ # 071005

Mfg # LU44524 24/card (nickel) EZ # 071014

Heavy Duty Bolt Snap

Large solid brass snap, bottom loop rotates so keys lie flat.

Mfg # LU44801 5 pk EZ # 010017



Boat Snap

Large heavy duty snap, bottom loop rotates so keys lie flat.

Mfg # LU44701 5 pk EZ # 066698



Double Ended Boat Snap

Medium sized snap with clips at each end, make for easy removal of keys.

Mfg # LU44901 5 pk EZ # 066699



Trigger Snap

Fastens securely to a belt loop, purse snap or similar item and features a loop which rotates 360°. Solid brass with a solid brass split key ring.

Mfg # LU44012 12/card (brass) EZ # 041239

Mfg # LU44001 5 pk (brass) EZ # 071205

Mfg # LU44101 5 pk (nickel) EZ # 010016



Key Releases

Quick Release Pull Apart Key Ring

Small end button separates keys without removing the key from the ring. Nickel plated brass with two 7/8" split key rings. Overall length is 3"

Mfg # LU70701 5 pk EZ # 010038

Mfg # LU70712 12/card EZ # 010037

Mfg # LU70725 75/jar EZ # 041248



3-Way Pull Apart

Supplied with one red end, one blue end and three 7/8" nickel plated tempered steel split key rings.

Mfg # LU71701 5 pk EZ # 029441



Key Release

Mechanical latch makes it easy to separate keys when necessary. Simply swing keys around to opening and release. Comes with five removable 1/2" nickel plated tempered steel split key rings.

Mfg # LU42701 05 5 pk EZ # 010010



Plastic Key Clip

Features a swivel, allowing rotation. Measures 3 1/2"; without 7/8" key ring. Supplied in assorted colors.

Mfg # LU41501 5 pk EZ # 010003

Mfg # LU41536 36/card EZ # 010004



Plastic Key Clip with Black Casing

Tough clip opens with touch of a button and closes with a click. 7/8" nickel plated split ring. Measures 3" without split ring.

Mfg # LU42001 5 pk EZ # 010008





Key Identifiers

Rubber-like vinyl key identifiers. Stretches to fit over heads of keys. Assorted colors.

Small

Mfg # LU16425 250/jar EZ # 071007
Mfg # LU16400 200/box EZ # 027986

Medium

Mfg # LU16700 200/display box (asst) EZ # 026862
Mfg # LU16704 4/cd./asst. EZ # 009979
Mfg # LU16706 4/cd./neon EZ # 028435
Mfg # LU16707 200/display box (neon) EZ # 071021
Mfg # LU16725 200/jar EZ # 041210

Large

Mfg # LU16615 150/box/asst EZ # 077760
Mfg # LU16625 100/jar/asst EZ # 071009

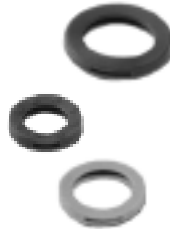

Sport Key Accessories

Lanyard

Fits around neck comfortably. Perfect to attach whistle or for keeping house keys secure, measures 21 1/2".

Mfg # LU41401 5 pk EZ # 066981
Mfg # LU41412 12/card EZ # 068355



Lanyard With Whistle

Made of strong woven nylon, measures 23" in length.

Mfg # LU42201 5 pk EZ # 066696



Wrist Coil With Whistle

Measures 2" in diameter, stretches to more than 12" in diameter. Durable plastic whistle is securely attached with 3/8" nickel plated tempered steel split ring.

Mfg # LU42301 5 pk EZ # 066697



Whistle

1" nickel plated tempered steel split ring. Whistle made of tough molded plastic.

Mfg # LU42101 5 pk EZ # 066982



Jailer Key Ring With Whistle

Find keys fast with this 3 1/2" brass plated steel key ring. Sturdy jailer ring slips over wrist to keep keys accessible. 1" brass plated steel split ring.

Mfg # LU91101 05 5 pk EZ # 041252



Chain & Connectors

Ball Chain

Ball chain attaches to both ends to create chain loops or to splice chain together.

Ball Chain

Mfg # LU31700 100 ft EZ # 009991

Connectors #6

Mfg # LU31900 100/pk EZ # 009992



Mity-Mite® Spool

Flat link, stainless steel chain on 100 ft spool. Connect lengths of chain with the 3/16" nickel plated steel split ring.

Spool

Mfg # LU43100 100 ft EZ # 010012

Split ring

Mfg # LU43000 100/pk EZ # 010011



Mity-Mite® Key Ring

Flexible, flat link stainless steel. Measures 5 3/8". Collapses to fit easily in a pocket.

Mfg # LU43201 5 pk. EZ # 071204
Mfg # LU43224 24/cd. EZ # 010013



18" Pocket Chains

Pocket Chain With Trigger Snap

Tough nickel finish steel link chain. Trigger snap secures to belt loop or purse strap. Overall length is 18 1/4".

Mfg # LU40101 5 pk EZ # 069564



Pocket Chain With Split Key Ring

Key ring attaches to wallet, keys or other back pocket item. Overall length is 16".

Mfg # LU40201 5 pk EZ # 071000



Pager Chain With Trigger Snap

Trigger snap secures chain to belt loop or purse strap. Supplied with 18" nickelplated steel chain.

Mfg # LU40001 5 pk EZ # 071183



Quick Clip

Holds keys in 2 separate sections. Main section can hold multiple key rings and the inside hook keeps keys secure.

Mfg # LU45801 5 pk/asst. EZ # 045441





Pull Apart Key Ring

To open and close, pull upward and outward from the top to release tension. Made of 1/8" diameter cadmium plated steel.



Mfg # LU74300	3 1/2" (25/box)	EZ # 014147
Mfg # LU74400	4 1/2" (sold ea.)	EZ # 026872
Mfg # LU74600	6" (sold ea.)	EZ # 026873

Split Key Rings

Mfg #	Size	Qty	EZ #
LU76000	1/2"	100/box	026874
LU76002	1/2"	5 pk/2 per cd	071011
LU76100	5/8"	100/box	026875
LU76102	5/8"	5 pk/2 per cd	071012
LU76200	3/4"	100/box	026876
LU76300	7/8"	100/box	026877
LU76400	1"	100/box	026878
LU76402	1"	5 pk/2 per cd	071026
LU76500	1 1/8"	100/box	026879
LU76600	1 1/4"	100/box	026880
LU76602	1 1/4"	5 pk/2 per cd	047789
LU76700	1 3/8"	100/box	026881
LU76800	1 1/2"	50/box	026882
LU76900	1 3/4"	50/box	026883
LU77000	2"	50/box	026884
LU77001	2"	5 pk/1 per cd	071029
LU77402	1" slim	5 pk/2 per cd	071554
LU79100	3"	25/box	009972



Heavy duty nickel plated tempered steel.

1" Color Rings

LU79425	asst.	Jar	077729
LU79430	Blue	24/pack	077933
LU79440	Green	24/pack	077932
LU79465	Purple	24/pack	077935
LU79466	Pink	24/pack	077936
LU79470	Red	24/pack	077937

Split Key Ring Display

Heavy-duty tempered steel nickel plated. Great for counter, pegboard or wall. 6" x 13" x 6".

Display contains:

Qty.	Size	Qty.	Size	Qty.	Size
40	1/2"	40	1"	25	1 1/2"
40	5/8"	30	1 1/8"	25	1 3/4"
40	3/4"	30	1 1/4"	25	2"
40	7/8"	30	1 3/8"		

Mfg # LU36500 365 pcs. EZ # 041231



Twisty

Flexible corrosion resistant aircraft cable. Locking connector opens/closes by forming a figure 8.

Mfg # LU81101	5 pk/asst	EZ # 010049
Mfg # LU81124	24/card/asst	EZ # 041250
Mfg # LU82901	5 pk (9" long, brass plated)	EZ # 027754



Tang Ring

Unique design makes it easy to get keys on and off. Saves fingernails. 1" in diameter.

Mfg # LU75200	100/box	EZ # 071031
Mfg # LU75202	5 pk/2 per cd	EZ # 071017



Give Away Ring

Ideal as giveaway with cut keys. Zinc plated steel, .0475" gauge wire.

Mfg # LU75800	1000/box/.85"	EZ # 071020
Mfg # LU75900	1000/box/1"	EZ # 026860



Binder Ring

Perfect for holding together multiple documents. Nickel plated steel.

Mfg # LU24300	1"/50 box	EZ # 075585
Mfg # LU24600	2"/25 box	EZ # 075601



C-Clip

- Anodized aluminum
- Clips to belt loop or purse
- Spring loaded gate keeps keys secure



Mfg # LU46001	5 pk / small	Asst. colors	EZ # 070756
Mfg # LU46020	10 pk / small	Black	EZ # 071625
Mfg # LU46030	10 pk / small	Blue	EZ # 071626
Mfg # LU46040	10 pk / small	Green	EZ # 071627
Mfg # LU46065	10 pk / small	Purple	EZ # 071628
Mfg # LU46070	10 pk / small	Red	EZ # 071629
Mfg # LU46093	10 pk / small	Silver	EZ # 071630
Mfg # LU46120	10 pk / large	Black	EZ # 071631
Mfg # LU46130	10 pk / large	Blue	EZ # 071632
Mfg # LU46140	10 pk / large	Green	EZ # 071633
Mfg # LU46165	10 pk / large	Purple	EZ # 071634
Mfg # LU46170	10 pk / large	Red	EZ # 071635
Mfg # LU46193	10 pk / large	Silver	EZ # 071636
Mfg # LU46101	5 pk / large	Asst. colors	EZ # 070757
Mfg # LU46000	126 pcs	display	EZ # 070063

Oval Key Rings

Anodized aluminum . Brass closure resists rusting.

Mfg # LU73701	5 pk / asst. colors	EZ # 071181
---------------	---------------------	-------------



Fix-O-Loc

Unique ball-knob and socket closure locks and unlocks easily. 5" length

Mfg # LU73101	Stainless steel	5 pk	EZ # 047790
Mfg # LU71101	Nylon coated	5 pk	EZ # 010039
Mfg # LU71124	Nylon coated	24/card	EZ # 071013





Belt Key Carriers

Secura-A-Key "Clip On"

The double locking release lever provides twice the protection from accidental key ring loss. Quickly clips onto belt, holds up under heavy use.

Mfg # LU40401 5 pk EZ # 009995
Mfg # LU40412 12/card EZ # 009994



Secura-A-Key "Slip On"

The double locking release lever provides twice the protection from accidental key ring loss. Preferred by law enforcement, slides through belt and holds up under heavy use.

Mfg # LU40501 5pk EZ # 009996



Okay's Key Safe

Slips through the belt, available in nickel plated steel. Comes with a 1 1/8" nickel plated tempered steel split key ring.

Mfg # LU47601 5 pk EZ # 041244



Clip On Belt Hook

A rugged, all steel belt hook with a 1 1/8" split key ring. Overall length is 4". Made of nickel plated tempered steel.

Mfg # LU40601 5 pk EZ # 009998
Mfg # LU40612 12/card EZ # 009997



Leather Belt Hook

Made of rugged leather with clip which allows removal of keys. Measures 6" and includes a 1 1/8" steel split key ring.

Mfg # LU45301 5 pk EZ # 010019



Leather Belt Hook With Bolt Snap

Made of rugged leather, bolt snap allows keys to be easily removed. Measures 6" and includes a 1 1/8" steel split key ring.

Mfg # LU45201 5 pk EZ # 029449



Soft Key Floats

Pliable vinyl-coated foam key holder is both buoyant and soft.
Size: 3 1/2" x 1 3/8" x 1".

Mfg # LU92801 Yellow - 5 pk EZ # 010026



Key Bak

Rugged key reel will outlast all of the other copies by years of service and reliability. 24" retractable pull of flat, linked steel chain. Measures 2 1/2" in diameter.



Clip On

Mfg # LU43501 each /chrome EZ # 010015
Mfg # LU43601 each /black EZ # 041240

Slip On

Mfg # LU43301 each /chrome EZ # 010014
Mfg # LU43401 each /black EZ # 047788

Spinner Bak

Mfg # LU43551 each /360° rotation EZ # 071004

Heavy Duty Key Bak

48" retractable pull of cable. Includes lifetime service policy;

Mfg # LU43701 each EZ # 071252



Mini-Bak

Prevent misplacing or losing keys, eliminate fumbling in a large purse or day pack. Features high impact plastic case and strong three-strand nylon cord.

Mfg # LU42801 5 pk EZ # 065223



Key Bak Super 48

48" kevlar cord provides strength and a smoother pull. Ball and socket locking mechanism holds multiple keys in place without releasing.

Mfg # LU43651 each EZ # 069568



Key Coils

Designer Key Coil

The coil measures 10" and can be extended to four feet.

Mfg # LU41601 5 pk(asst) EZ # 010006
Mfg # LU41612 12/card EZ # 010005



Mini Designer Key Coil

Measures 6" and can be extended to 48"
Trigger snap keeps keys on belt loop.

Mfg # LU41301 5 pk (asst) EZ # 071022
Mfg # LU41312 12/card (asst) EZ # 070898



Neon Wrist Coil Key Holder

Measures 2" in diameter - stretches to more than a foot.

Mfg # LU41006 05 5 pk /neon EZ # 041233
Mfg # LU41001 5 pk /asst EZ # 041233





Rock Key Hider

Slot in bottom holds spare keys. Use in gardens next to house or garage.

Mfg # LU90601 3 pk/1 per card EZ# 069560



Key Light

Ideal for anyone who needs to quickly feel for a key and light up the key hole in the dark. Replaceable battery.

Mfg # LU90801 5 pk/1 per card EZ # 010051



Luggage Tag

Simulated leather tag, plastic cover to protect paper insert. 2 1/4" x 3 1/2"

Mfg # LU63101 5 pk/1 per card EZ # 010032



Photo Holder

Holds wallet and school photos, clear acrylic resists scratching. Photo holder measures: 2 3/8" x 3 1/4"

Mfg # LU20501 5 pk/1 per card EZ # 066980



Skeleton Keys

For use on French doors and other antique door hardware. Brass plated zinc will not rust or bend under continuous use.

Mfg # LU87002 Flat tip 5 pk/2 cd EZ # 071182

Mfg # LU87102 Notch tip 5 pk/2 cd EZ # 074879

Mfg # LU87202 Flat & Notch 5 pk/2 cd EZ # 073395



Key & Coin Cases

Leather Key Case

Genuine cowhide, comes with detachable key hook levers. #936 measures 2" x 3 1/2" and #939 measures 3 1/2" x 4 1/2".

Mfg # LU93601 6-Hook 5 pk/1 cd EZ # 010066

Mfg # LU93901 12-Hook 5 pk/1cd EZ # 010067



Leather Key Case With Snap

Compact leather case holds 6 keys on permanent metal hooks. Inside pocket for spare cash.

Mfg # LU93551 5 pk/1cd EZ # 071003



Key Saver

Same size as credit card to fit in your wallet.

Mfg # LU91601 5 pk/2 std keys EZ # 010059

Mfg # LU91701 5 pk/1 std keys EZ # 010060



Squeeze Coin Holder

Handy pocket coin holder that doubles as a key chain. Squeeze it open for easy access to coins and it snaps easily back into shape.

Mfg # LU94101 5 pk/1cd EZ # 041254



Key Hiders

Magnetic Key Hiders

2 magnets for extra gripping power on automobiles or any steel surface. Made of rugged black plastic. Standard size is 3" x 1 7/8" x 5/8", XL is 4" x 2 1/8" x 5/8".

Mfg # LU91001 5 pk/1 cd - hiders EZ # 010053

Mfg # LU91012 12/box - refill hiders EZ # 010054

Mfg # LU91200 6/box - extra large EZ # 010056

Mfg # LU91201 5 pk/1 cd - extra large EZ # 010057

Mfg # LU91210 10/card - extra large EZ # 029444



Pouch Key Hider

Allows a key to be hidden on non magnetic surfaces. Consists of two hook and loop nylon pieces, a pouch with 1/2" fold over flap. Standard Size - 2" x 4" x 1/8".

Mfg # LU91401 5 pk / 1 cd EZ # 029443

Mfg # LU91410 10/card - Velcro EZ # 028754

Mfg # LU91301 5 pk/1 cd - extra large EZ # 010058

Mfg # LU91308 8/card - extra large EZ # 071046



Wallet Key Hider

Same size as a credit card and will hold two standard keys or one large-headed key. Measures 3 3/8" x 2 1/8"

Mfg # LU90901 5 pk/1 cd EZ # 065222



Key Hider

Display stands on a counter or hangs on a wall. All displays measure 9" x 14". 10/display.

Mfg # LU91010 EZ # 010052



House Key Display

160 house keys per display in assorted colors. Size: 14 1/2" x 7" x 14 1/2"

Mfg # LU15300 EZ# 068237



The House Key

Exclusive house design molded directly onto key blank. Supplied in black, bright blue, teal, purple, neon pink, red & yellow

Mfg # LU15125 Schlage/Jar/80/asst EZ# 070273

Mfg # LU15225 Kwikset/Jar80/asst EZ# 070272





Install-A-Lock Door Reinforcement Plates

Mfg# B.S. Thick. Overall Dim. EZ #

For Door Locks with 2 1/8" Bore

MG1AB	2 3/8"	1 3/8"	4" x 9"	010830
MG1PB	2 3/8"	1 3/8"	4" x 9"	010832
MG1S	2 3/8"	1 3/8"	4" x 9"	010833
MG2AB	2 3/8"	1 3/4"	4" x 9"	010841
MG2PB	2 3/8"	1 3/4"	4" x 9"	010843
MG2S	2 3/8"	1 3/4"	4" x 9"	010845
MG3PB	2 3/4"	1 3/8"	4 1/4" x 9"	010882
MG3S	2 3/4"	1 3/8"	4 1/4" x 9"	010883
MG4AB	2 3/4"	1 3/4"	4 1/4" x 9"	043139
MG4PB2	2 3/4"	1 3/4"	4 1/4" x 9"	070913
MG4PB	2 3/4"	1 3/4"	4 1/4" x 9"	010890
MG4S	2 3/4"	1 3/4"	4 1/4" x 9"	010893
MG4S2	2 3/4"	1 3/4"	4 3/4" x 9"	029227



MG1-MG4

For Installing Deadbolts with 1 1/2" Bore

MG5PB	2 3/8"	1 3/8"	4" x 4 1/2"	010917
MG6BN	2 3/8"	1 3/4"	4" x 4 1/2"	036076
MG6PB	2 3/8"	1 3/4"	4" x 4 1/2"	010927
MG6S	2 3/8"	1 3/4"	4" x 4 1/2"	010928
MG7PB	2 3/4"	1 3/8"	4 1/4" x 4 1/2"	010933
MG7S	2 3/4"	1 3/8"	4 1/4" x 4 1/2"	036078
MG8S	2 3/4"	1 3/4"	4 1/4" x 4 1/2"	010941



MG5-MG8

For Installing Deadbolts with 2 1/8" Bore

MG51AB	2 3/8"	1 3/8"	4" x 4 1/2"	010920
MG51PB	2 3/8"	1 3/8"	4" x 4 1/2"	010922
MG51S	2 3/8"	1 3/8"	4" x 4 1/2"	010923
MG61AB	2 3/8"	1 3/4"	4" x 4 1/2"	010929
MG61PB	2 3/8"	1 3/4"	4" x 4 1/2"	010931
MG61S	2 3/8"	1 3/4"	4" x 4 1/2"	010932
MG81PB	2 3/4"	1 3/4"	4 1/4" x 4 1/2"	010946
MG81S	2 3/4"	1 3/4"	4 1/4" x 4 1/2"	010947

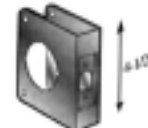

MG51-MG81

For Lock and Deadbolt – 2 1/8" Top and Bottom Bore – 3 5/8" Between Centers

MG261PB	2 3/8"	1 3/4"	4" x 9"	010879
MG261S	2 3/8"	1 3/4"	4" x 9"	029840
MG481S	2 3/4"	1 3/4"	4 1/4" x 9"	010912



MG261-MG481

Blank Channels with Mounting Holes Only

MG30PB	N/A	1 3/8"	4 1/4" x 9"	036081
MG30S	N/A	1 3/8"	4 1/4" x 9"	010884
MG40PB	N/A	1 3/4"	4 1/4" x 9"	010897
MG40S	N/A	1 3/4"	4 1/4" x 9"	010898
MG80PB	N/A	1 3/4"	4 1/4" x 4 1/2"	010943
MG80S	N/A	1 3/4"	4 1/4" x 4 1/2"	010944



MG30-MG80

For Simplex 1000 & L1000 Series, Alarm Lock DL- 2500 9" Units for Key-in-Knob Conversion 14" for Mortise Conversion

MG1000 9S	2 3/4"	1 3/4"	5" x 9"	010839
MG1000 14S	2 3/4"	1 3/4"	5" x 14"	010838
MG1000 14AB	2 3/4"	1 3/4"	5" x 14"	045471



1000

AB = Antique Brass **PB** = Polished Brass
S = Stainless Steel **BN** = Bronze

Mfg# Door B.S. Overall Thick. Dim. EZ #

For Alarm Lock T2

MG1027 14AB	2 3/4"	1 3/4"	5" x 14"	077464	1027
MG1027 14S	2 3/4"	1 3/4"	5" x 14"	068280	



Cover Simplex Prep., 2 1/8" Bore 4 1/4" From Bottom for Key-In-Knob

MG1004 14S	2 3/4"	1 3/4"	5" x 14"	036100	1004
------------	--------	--------	----------	--------	------



For Marks I-Que

MG1014IQS	2 3/4"	1 3/4"	5" x 14"	083373	1014
-----------	--------	--------	----------	--------	------

For Mortise Locks – 1 1/4" x 8" Faceplate W/Sex Bolts

MG504S	2 3/4"	1 3/4"	5" x 12"	010919	504
MG504PB	2 3/4"	1 3/4"	5" x 12"	041293	

Contemporary Door Reinforcer For All Locks With 2 1/8" Bore

MG2036PBV	2 3/8"	1 3/4"	4" x 3"	030445	2036
-----------	--------	--------	---------	--------	------

Mas Hamilton Power Lever Series 3000

MG3000 14S	2 3/4"	1 3/4"	5" x 14"	074497	3000
------------	--------	--------	----------	--------	------

Uni-Force – Door Edge Guard

MG10PB	–	1 3/8"	1" x 4 1/2"	010836	10PB
MG10AB	–	1 3/8"	1" x 4 1/2"	010834	
MG20AB	–	1 3/4"	1" x 4 1/2"	010847	20AB
MG20PB	–	1 3/4"	1" x 4 1/2"	010849	
MG20S	–	1 3/4"	1" x 4 1/2"	010850	20S



2036 PBV



Uni-Force

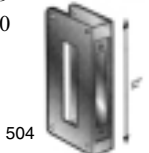

3000

Adjust-A-Strikes

2 3/4" Adjust-A-Strike For Wood Frames With 1/4" Adjustment

MG450B	EZ # 010899	450
MG450C	EZ # 010900	



4 7/8" Adjust-A-Strike For Wood Frames With 1/4" Adjustment

MG452B	EZ # 010903	452
--------	-------------	-----



2 1/4" Extended Lip Strike With 2" Lip

MG4521PB	EZ # 073367	4521
----------	-------------	------

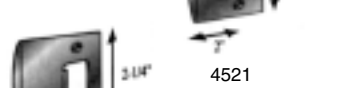

2 1/4" Extended Lip Strike With 2 1/2" Lip

MG4522PB	EZ # 073368	4522
----------	-------------	------



2 3/4" Extended T-Strike With 2" Lip

MG4526PB	EZ # 073369	4526
----------	-------------	------



2 3/4" Extended T-Strike With 2 1/2" Lip

MG4527PB	EZ # 073370	4527
----------	-------------	------



2 3/4" Extended Adjust-A Strike With 3" Lip

MG4530B	EZ # 036105	4530
---------	-------------	------



B = Brass Plated
C = Chrome Plated



Hasps • Drawer & Cabinet Locks

Patio Door Locks

Keyed Patio Door Lock
Inside or outside use, operated by key and lever.
Mfg # MG8756 EZ # 060195

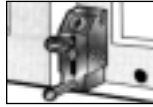

4" Slide Bolt, Solid Brass

For doors, windows & cabinets 2 strikes incl.
Mfg # MG8763-PB EZ # 073364

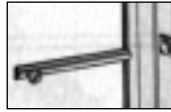

Door Viewers - Fits 1 3/8" to 2" doors

160° viewer, 1/2" dia., optical glass
Mfg # MG8720BR EZ # 041331



190° viewer, 1/2" dia., optical glass
Mfg # MG8724BR EZ # 041333
Mfg # MG8724C EZ # 077233

160° viewer, 1/2" dia., plastic lens
Mfg # MG8726 EZ # 073371



200° viewer, 9/16" dia., optical glass
Mfg # MG8729 EZ # 065722

Flush/Slide Bolts

6 3/4" x 1" Face, 12" Rod
Mfg # MG9256 605 EZ # 076332
Mfg # MG9256 626 EZ # 076333

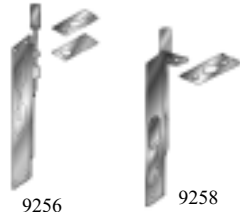

6" x 3/4" Face, 1" Bolt Throw
Mfg # MG9258 605 EZ # 076330
Mfg # MG9258 626 EZ # 076331

Kick Down Door Holder

Mfg # MG9226DU EZ # 081800
Mfg # MG9226CP EZ # 077319

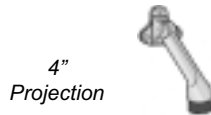

Flip Locks

Tamper-Proof Flip Lock
• For in-opening doors • Left or right handed
Mfg # MG8700BR EZ # 041310



Standard Privacy Flip Lock
• For in-opening doors only • Left or right handed
Mfg # MG8705BR EZ # 041326



Drawer & Cabinet Lock

• Fits up to 7/8" thick drawer • 3/8" locking bar throw
• Two keys included
Mfg # MG8777 EZ # 065716
• 90° & 180° stops included
• 2 tailpieces for universal application
• For drawer 5/8" thick • Two keys included
Mfg # MG8776-B EZ # 073376



Chain Door Guards

Chain Door Guard
For wood or metal door w/extra long screws.
Mfg # MG8707PB EZ # 073373



Keyed Chain Door Guard
Locks from inside or outside.
Mfg # MG8708 EZ # 065701



Tamper-Proof Chain Door Guard
Hookup keeps chain tight.
Mfg # MG8709BR EZ # 041327



Chain Door Guard
For wood or metal doors. Antique brass.
Mfg # MG8710 EZ # 065709



Bar Door Guards

Security Pinned Door Guard
Mfg # MG8712BR EZ # 041329



Swing Bar Door Guard
Mfg # MG8715BRASS EZ # 050331



Push/Pull Plates & Handles

Mfg. #	Fin.	EZ #
MG9032 605	4 x 16 push plate	076317
MG9032 613	4 x 16 push plate	076318
MG9032 630	4 x 16 push plate	077309
MG9032 628	4 x 16 push plate	076319
MG9042 605	4 x 16 pull plate	076314
MG9042 613	4 x 16 pull plate	076315
MG9042 630	4 x 16 pull plate	079287
MG9042 628	4 x 16 pull plate	076316
MG9010 605	8 x 34 kick plate	076320
MG9010 628	8 x 34 kick plate	076321
MG9010 630	8 x 34 kick plate	077297
MG9066 606	6 5/8" x 1 3/4" door pull	081049
MG9066 619	6 5/8" x 1 3/4" door pull	081050
MG9069 605	6" door pull	081051
MG9069 628	6" door pull	081052



Rim Locks

Single Cylinder Deadlock
Thumbturn inside, angle strike, jimmy proof
vertical bolt, surface mounted, 2 keys incl.
Mfg # MG8000 EZ # 060194



Double Cylinder Jimmy Proof Deadlock
Pin locks into retaining ring, prevents outside removal.
Mfg # MG8003 EZ # 060196



3-Way Night Latch
Deadlocks, automatic lock or hold open, angle strike
Mfg # MG8006 EZ # 060391



Replacement Rim Cylinder, Brass Finish
Mfg # MG8008 EZ # 060390





Latch Guards

7"

In-Opening Doors
 MG8840B
 EZ # 029486
 MG8840C
 EZ # 029865
 MG8840DU
 EZ # 031173



12"

In-Opening Doors
 MG8843B
 EZ # 029866
 MG8843C
 EZ # 029867

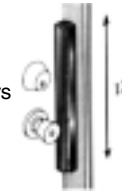

6"

In/Out Opening Doors
 MG8844AL
 EZ # 062907



6"

Out-Opening Doors
 MG8845B
 EZ # 029868
 MG8845C
 EZ # 029869

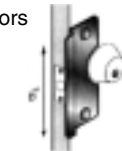

7" Heavy Duty
 Out-Opening Doors

MG8848B
 EZ # 029870
 MG8848C
 EZ # 029485
 MG8848DU
 EZ # 062070



11 3/4" Universal
 Out-Opening Doors

MG8849AL
 EZ # 050312
 MG8849DU
 EZ # 050313

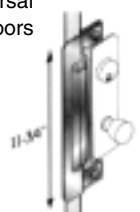

11 3/4" Universal
 Out-Opening Doors

MG8850B
 EZ # 029871
 MG8850C
 EZ # 029484
 MG8850DU
 EZ # 041343



11"

Out-Opening Doors
 MG8851AL
 EZ # 072148
 MG8851DU
 EZ # 066580



6 1/2"

Out-Opening Doors
 MG8852AL
 EZ # 029872
 MG8852DU
 EZ # 029873



12"

Narrow Stile
 Out-Opening Doors
 MG8853DU
 EZ # 029875

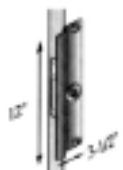

AL = Aluminum
B = Brass
C = Chrome
DU = Duranodic

12"

Removable For Flush Doors
 MG8854AL
 EZ # 029876
 MG8854DU
 EZ # 029877



12"

For Center Hung Door, 4" Frame
 MG8855AL
 EZ # 029878
 MG8855DU
 EZ # 029879



12"

For Center Hung Door, 4 1/2" Frame
 MG8856AL
 EZ # 029880
 MG8856DU
 EZ # 029890

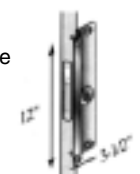

4"x7"

Narrow Stile
 Out-Opening Doors
 MG8858AL EZ # 029881



Filler Plates

1 1/8" x 2 1/4"
 For 161 Cut Out
 MG8873PC
 EZ # 029887
 MG8873B
 EZ # 073372



1 1/4" x 8"
 For 86 Mortise Lock
 Face Cut Out
 MG8875PC
 EZ # 029860

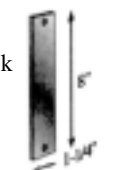

1 1/4" x 4 7/8"
 For ASA
 Strike
 MG8880PC
 EZ # 029862



1" x 2 1/4"
 For 160 Cut Out
 MG8872PCB
 EZ # 066581



1 1/4" x 8"
 Converts 86 cut
 out to 161 Prep
 MG8886PC
 EZ # 066579



Filler Plate

MG8885PC
 EZ # 029864
 Contains 1 Ea: 8868, 8873, 8880



Wall Patch

3 1/4" Wall Patch
 MG390W
 EZ # 073365
 5" Wall Patch
 MG391W EZ # 073366

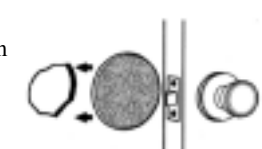

Adapter Plates

2 5/8" O.D.
 For Rim / Mortise Cyl.
 Covers up to
 2 1/8" Dia. Hole
 1 1/4" Inside Dia.

MG8860C
 EZ # 029882
 MG8860B
 EZ # 029883



2 3/4" O.D.
 For Installing Schlage
 Deadbolts with 1 1/2"
 Bore in a 2 1/8" Hole

MG8863B
 EZ # 029482
 MG8863C
 EZ # 029884



Cover Plates

3 1/2" O.D. For
 2 1/8" bore locks
 To change from
 2 3/8" to 2 3/4"
 backset. 2 Per Card
 Covers Damaged Door

MG8865AB.....EZ # 029888
 MG8865BEZ # 029889
 MG8865C.....EZ # 029885



Hole Covers

Covers 1 1/2" holes
 MG8835PCB EZ # 077278
 Covers 1 1/2" to 2 1/8" holes
 MG8868B EZ # 041341
 MG8868C EZ # 041342
 MG8868PC EZ # 029481
 Covers 2 1/8" holes
 Fits under rim panic hardware
 MG8870PC EZ # 029886

PC = Prime Coat

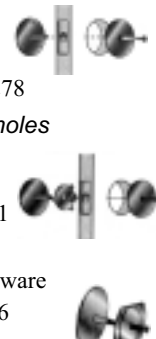



Sliding Door Locks

Sliding Door Lock 8820

Heavy gauge steel, adjusts to fit 28" to 48" door, mounts on inside or outside.

Mfg # MG8820 EZ # 029383

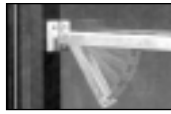

Sliding Patio Door Pin Lock

Locks into retaining ring, prevents removal from outside

Mfg # MG8752 EZ # 041339

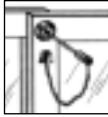

Sliding Door Lock

Foot or hand operated, mounts on top or bottom

Mfg # MG8755 EZ # 045479

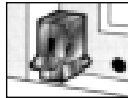

Privacy Pocket Door Lock

Polished brass for 1 3/8" - 1 3/4" thick door

Mfg # MG9349 605 EZ # 041340



Door Stops

Mfg. #	Fin.	EZ #
MG9181 605	2 1/2" Wall stop	035992
MG9181 613	2 1/2" Wall stop	078373
MG9181 630	2 1/2" Wall stop	076323
MG9182 605	2 1/2" Concave wall stop	076324
MG9182 613	2 1/2" Concave wall stop	078370
MG9182 630	2 1/2" Concave wall stop	076325
MG9199 605	3/8" High dome stop	076328
MG9199 613	3/8" High dome stop	078372
MG9199 626	3/8" High dome stop	076329
MG9200 605	3/8" Low dome stop	076326
MG9200 613	3/8" Low dome stop	078371
MG9200 626	3/8" Low dome stop	076327
MG9238 628	3" rigid base stop	081054
MG9239 628	3 3/4" rigid base stop	081055
MG9243BP	3" rigid base stop	081053
MG9244BP	3 3/4" rigid base stop	081056
MG9251GRY	Door silencer	078598
MG9252GRY	Door silencer	076380
MG9405 626	Door Coordinator	081057

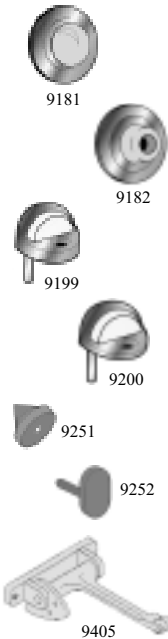

Door Hardware

Tubular Passage Latch

Adjustable backset 2 3/8" or 2 3/4"

Mfg # MG8789 EZ # 073374

Solid Brass Tulip Door Knob

2 each knobs with spindle

Mfg #MG8864PB EZ # 062911

Brass Plated Door Knob Roses

2 1/2" diameter, 2 each

Mfg # MG8867PB EZ # 073375

Glass Knob

2 each knobs with brass trim and spindle

Mfg # MG8866G EZ # 062910



Elbow Catch

Mfg # MG9284 BP Brass EZ # 077295

Mfg # MG9284 CP Chrome EZ # 077296



Window Locks

Sliding Window Lock

W/pointed security screw, heavy duty for window or door. Carded: 2ea

Mfg # MG8732AL EZ # 041334

Mfg # MG8733AL (50 pcs.) EZ # 041337



Lever Window Lock

Move lever to lock or unlock

Mfg # MG8738 EZ # 062895



Double Sliding Window Lock

With 2 pointed security screws

Mfg # MG8742 EZ # 065711



Sliding Window Lock

Fits wide or narrow tracks, 2 per card

Mfg # MG8746AL EZ # 041338



Window Locks

Keyed Wood Sash Window Lock

For double hung windows

Mfg # MG8758 EZ # 065712

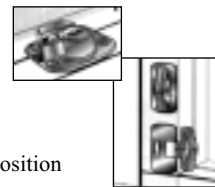

Double Hung Wood Window Lock

Secures window in vented or closed position

Mfg # MG8760 EZ # 070942

Double Hung Window Lock

6 screws secure 3 windows, special key incl.

Mfg # MG8761 EZ # 062901



Wood Sash Cam Window Lock

Pulls double hung windows together

Mfg # MG8764 EZ # 065713

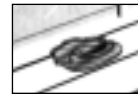

Strike Plates

Mfg. #	Desc.	EZ #
MG747B	4 7/8" x 1 1/4"	027732
MG747C	4 7/8" x 1 1/4"	010936
MG31B	4 7/8" x 1 1/4"	041291
MG31C	4 7/8" x 1 1/4"	041292

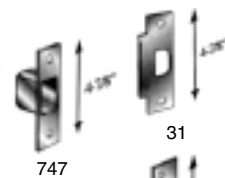

Heavy Gauge Deadbolt Strike

MG760B 1 1/8" x 6" 038441

MG765B 1 5/8" x 7 3/4" 036095

MG765C 1 5/8" x 7 3/4" 036096

Security Strike For Deadbolts

MG755B 1 5/8" x 4 7/8" 041295

Heavy Gauge Lip Strike

MG770B 1 1/4" x 8" 041296

MG770C 1 1/4" x 8" 045470

Double Lip Strike

MG775B 1 5/8" x 11" 036098

MG775C 1 5/8" x 11" 036099

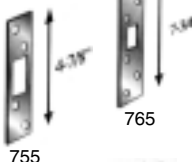

B = Brass Plated C = Chrome Plated

4 1/2" Keyed Locking Hasp

Mfg # MG8772 EZ # 062904

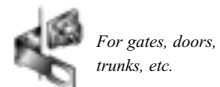

For gates, doors, trunks, etc.



Speed Mortiser

Make a mortise cavity in no time with this one of a kind tool! The MRHIT38 is fully adjustable for mortise height and includes carrying case and 1" bit standard

MFG# MRHIT38 EZ# 068329

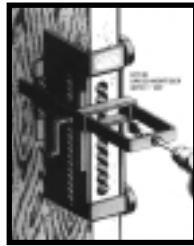

Garage Blok

Jimmie-proof, fortress-like shield for the garage, warehouse, overhead or swinging doors. Available in both right and left side models.

Mfg. # MRA500L EZ # 065810

Mfg. # MRA500R EZ # 065811



Padlock Not Included

Lever Kee-Blok

Blocks all existing keys to a lever handle lock in seconds. Fits most lever handle locks and can attach in seconds!

Mfg. # MRA200KA EZ # 068318



Knob Kee-Blok

- Fits 90% of all knob locks
- Prevents entry of any existing keys
- Added protection!
- High strength aluminum alloy

Mfg. # MRA100KD EZ # 011136

Mfg. # MRA100KA EZ # 026892



Door Lifter

Removing a door from its frame has never been easier! in just a few easy steps, the door is lifted and swiveled out of the way on a ball-bearing base.

Mfg. # MRDL150 EZ # 082648



Octopod

This versatile deadbolt lock is ideal for sliding doors and windows, swinging doors, double doors and French doors.

1 1/8" mortise cylinder not included

Aluminum Powdercoat #1 gear

Mfg # MR5002-1-9A EZ# 035138

Duranodic Powdercoat #1 gear

Mfg # MR5002-1-9D EZ# 035139



Installation at base of sliding patio door

MRHIT38MB Drill Bits

Don't get stuck on the job without having spare bits!

1" Mortise Bit

Mfg # MRHIT38MB1 EZ# 068330

7/8" Mortise Bit

Mfg # MRHIT38MB2 EZ# 068331

3/4" Mortise Bit

Mfg # MRHIT38MB3 EZ# 068332

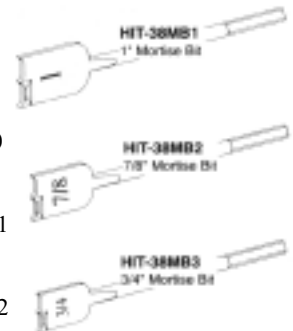

Lock Mounting Bracket

Great for installing cylindrical knob locks or dead-bolts on metal doors.

Mfg # MRLMB01 EZ# 065840

Used with ASA strike in a steel frame

Mfg # MRLMB05 EZ# 068323

Designed for mortise locks on metal doors with or without a center seam.

Mfg # MRLMB02 EZ# 068322

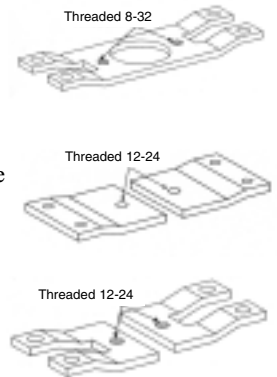

File Cabinet Bar

File cabinet locking bar mounts on left hand side of cabinet for standard applications. Will not block adjoining cabinets when locked or unlocked.

Mfg#	Desc	EZ #
MRFB2L	23.5" OAL for 2 drawer cabinets	075874
MRFB3L	33" OAL for 3 drawer cabinets	075873
MRFB4L	49.5" OAL for 4 drawer cabinets	075064
MRFB5L	55" OAL for 5 drawer cabinets	075065



Jamb Jacket

Repairs and covers damaged door jambs without replacing the whole jamb.

24 - 1 3/4 door ... 24" long plate

Mfg # MRJLL134 24 EZ# 068319

24 - 1 3/8 door ... 24" long plate

Mfg # MRJLL138 24 EZ# 065839





Aluma Guard

Protect aluminum framed glass doors against forced entry and door/frame separation.

Aluminum Powdercoat
 Mfg # MRAG1A EZ# 065812
 Duranaodic Powdercoat
 Mfg # MRAG1D EZ# 065813



Master Lock Keying Tool

Keying tool for Master Lock "UP" series uncoded locks.

Mfg # MRMKP1 EZ# 068327



Cylinder Tool For Kwikset 400 Series

Quickly removes cylinder from lock and removes cylinder retaining clip. Handle is following tool with master wafer unload feature.

Mfg # MRKCT2
 EZ# 069589



Schlage Cylinder Removal Tool

- Side A will easily remove the threaded cap from cylinders.
- Side B is used to depress the cylinder cap pin and turn the tailpiece

Mfg # MRSCT1 EZ# 011139



Locking Surface Bolt

6" bolt complete with two types of strikes and fasteners. Full 1 1/8" throw can be locked in the open or closed position. Base size is 2" x 5 1/2".

Mfg # MR76 EZ# 074952



Safe Info Charts

Magnetic backed, re-useable "info charts", Allows quick, easy information to be displayed for customers benefit.

Mfg # MRSIC5 EZ# 041349



Secret Gate Latch

- Hidden button in bottom of case retracts latch for the informed
- Exposed dummy knob frustrates the unwelcome intruder
- Includes strike plate, mounting screws and dummy knob

Mfg # MR200SPB EZ# 068170



Safe Door Hinge Shim Kit

Contains 9 different sizes (10 of each) of precision brass hinge shims.

Mfg # MRHSK10 EZ# 029717



Tangle Resistant Cylinder Springs

Use these springs wherever you use standard springs to prevent tangling.

Mfg # MRTRS100 EZ# 068326



Cylinder Accessory Kit

Contains an assortment of popular hardened cylinder guards, plus cylinder collars molded from an "Engineered Plastic".

Mfg # MRCAK15 EZ# 072982



Locksmith Screw Assortment

Includes an assortment of 18 of the most commonly used screws for servicing locks

Mfg # MRLSA1 EZ# 068328



Cylinder Gard

Stops a wrench from gripping and crushing! The gard forms a cone of hardened steel protection for rim and mortise cylinders.

Aluminum powdercoat / 5 per pack
 Mfg # MRCGA5 EZ# 065815
 Duranodic powdercoat / 5 per pack
 Mfg # MRCGD5 EZ# 065816



Jamb Pins

Secures out-swinging doors with loose pin hinges.

MRJP10: Residential hinges using #10 screw.
 Machine screw thread is 10-24. 2 per pack.
 EZ # 068320

MRJP12: Commercial hinges using #12 screw.
 Machine screw thread is 12-24. 2 per pack.
 EZ # 068321





Deadlocks • Gate Locks

Mortise Locksets

Georgian

- Solid brass handle assy.
- 2 1/2" backset
- Faceplate, 1 1/16" x 7 5/8"
- Mortise lock, reversible

Mfg # MH8600A3 EZ # 011013

Knob/Rose Mortise Locksets

- Solid brass knob
- 2 1/2" backset
- W - Faceplate, 1" x 7 1/8"
- T - Faceplate for 1 1/16" x 7 5/8"
- Mortise lock, reversible

Mfg # MHT22AC3 EZ # 041362

Mfg # MHW22AC3 EZ # 041363

New Yorker

- Wrought brass trim
- 2 3/4" backset
- Trim outside - 10" x 2 3/4" inside - 7" x 2 1/4"
- Mortise lock, reversible

Mfg # MH7NY10A3 EZ # 011011

Classic

- Wrought brass trim
- 2 3/4" backset
- Trim 8" x 2 1/2"
- Mortise lock, reversible

Mfg # MH7CL10A3 EZ # 041379

Mfg # MH7CL10A32D EZ # 041380

Mfg # MH7CL10B3KA2 EZ # 041382

Mfg # MH7CL10B32D EZ # 041384

Thinline

- Solid brass trim
- 1" backset
- Latch: 1/2" projection
- Hub: high strength, solid steel

Mfg # MH2750C3 EZ # 041377

A = Stopbutton Locks Knob
 AC = Double Cylinder With Deadbolt
 B = Deadbolt Locks Knob C = Double Cylinder Entrance

Replacement Knobs

Heavy duty round 2 1/4" with threaded bushing. (Sold Each)

Mfg # MH52522 3 EZ # 041391

Mfg # MH52522 32D EZ # 041392

Mfg # MHK22T 3 EZ # 041390 (Sold Per Pair)

Mortise Deadlocks 2000/3000 Series

- Bolt-1" throw • Case-High-pressure cast
- Front- 1 1/16" x 4 5/8" plate • Reversible
- Supplied with turnpiece only • Less Cylinder

2000 series 2 1/2" backset

Mfg # MH2000X3 EZ # 041378

Mfg # MH2000X26D EZ # 026901

3000 series 2 3/4" backset

Mfg # MH3000X3 EZ # 026899

Mfg # MH3000X26D EZ # 026900

Grade 2 Cylindrical Locksets

- Latch: 1/2" throw, adjustable bevel front.
- Knobs: Steel reinforced, 2 1/4" dia. round
- Solid brass, 5 pin Cylinders, (drilled 6)

Mfg #	Desc.	EZ #
MH110N32D	Passage	041375
MH110S32D 4C	Classroom	041376
MH110AB32D C	Entry	041364
MH110AB32D 4C E4	Entry	041366
MH110RAB32D 4 E4	I/C Entry	041373
MH110F32D 4C E4	Storeroom	041371
MH110DC32D 4C E4	Dbl. Cyl. Communicating	041367
MH110DW3 4C E4	Dbl. Cyl. Institutional	041368
MH110DW32D 4C E4	Dbl. Cyl. Institutional	041369

4 - 2 3/4" T-Strike E4 - 2 3/4" backset C - SCI Keyway

140 Series Deadlatch

- For 1 5/8" to 1 7/8" door • ANSI 156.5, Grade 1
- Cylinder 6 pin, Marks "C" keyway

Mfg #	Desc.	EZ #
MH140K32D E6 2 3/8	Sgl Cyl 2 3/8" b.s.	075534
MH140M32D E6 2 3/8	Dbl Cyl 2 3/8" b.s.	075535
Parts		
MH1434D 32D	Latch f/ 2 3/4" b.s.	075864
MH1438D 32D	Latch f/ 2 3/8" b.s.	075865
MH1354L	Ilco/Lori tail piece	075536

Replacement Parts & Accessories

Mfg #	Desc.	EZ #
MH9010	Deadbolt spring	041386
MH9021	Hub lever	041387
MH9035S3	Mortise lock strike	041388
MH9053	Hub lever spring	041389
MH1138A32D	2 3/8" Deadlatch- Grade 2	010999
MH1134A32D	2 3/4" Deadlatch- Grade 2	010993
MH2621A3	Sngl. Cyl. Profile AW/KW	081036
MH2621C3	Sngl. Cyl. Profile SCH	081037
MH2622A3	Dbl. Cyl. Profile AW/KW	081038
MH2622C3	Dbl. Cyl. Profile SCH	081039



Survivor Leversets

- Lock mechanism clutch system • 2 3/4" backset • Door thickness 1 5/8" to 1 7/8"
- 170: ANSI A156.5, Grade 2 • 190: ANSI A156.2, Grade 1, U.L. listed, 3 hr fire rating

Mfg #	Desc.	EZ #	Mfg #	Desc.	EZ #
Grade 2			Grade 1 Interchangeable core		
MH170AB26D	Entry	063495	MH195RAB26D 2 3/4	Entry	063418
MH170F26D	Storeroom	063497	MH195RDB26D	Class Intrud	074671
MH170L26D	Privacy	063500	MH195RF26D	Storeroom	063493
MH170N26D	Passage	063499	MH195RS26D	Classroom	063494
Grade 1			Parts		
MH195AB26D 2 3/4	Entry	063419	MH1903L (tail piece f/ AB, F)		074674
MH195DB26D	Class Intrud	074670	MH1903SL (tail piece f/ S)		074675
MH195F26D	Storeroom	063491			
MH195L26D	Privacy	074673			
MH195N26D	Passage	074672			
MH195S26D	Classroom	063492			



170



195

I Que Electronic Series

- 16 digit programmable keypad • Non-handed design
- Optional IC Core compatibility • Proprietary energy mgmt. system for extended battery life
- 3-9 digit access codes • All weather, heavy duty grade 1 construction • I-Que Metro - Grade II latch
- Survivor "Clutch" system for trouble free service • UL listed 3 hour fire rating • ADA Compliant
- Single use codes and programmable entry times on I-Que 1K • Holiday & multi-year scheduling
- Metro I-Que is not upgradeable • Multiple time zones on I-Que 1K using I-Dat

Mfg #	Desc.	EZ #
MHIQ1K03	64 user/64 audit	075156
MHIQ1K03G1G3	64 user/ IC/LC	075155
MHIQ1K26D	64 user/64 audit	074676
MHIQ1K26D W1	Sensor array pkg	074679
MHIQ1K26DG1	64 user/ audit IC	074963
Accessories		
MHEA1903C	Schlage tailpiece	075537
MHE1903L	Iico tailpiece	075533
MHEA6000	I Dat download module	074964
MHEK1038	1 3/8 spacer	080663
Upgrade Packages		
MHEU1	160 user / 832 audit	074677
MHEU2	320 user / 1,600 audit	074678
MHEU3	512 user / 2,208 audit	080442
Metro Series		
MHIQ1K METRO1 IC	32 user/IC	080237
MHIQ1K ME26D T	32 user/tactile metal	085007
MHIQ7K 26D	Exit device trim/32 user	080893
MHIQ7K M1 26D	Exit device trim/32 user	080894
Adapter plates		
MHE7071	For VD 99	080895
MHE7073	For CRED5200	080896
MHE7075	For Sarg. 8800	080897



I-Que 1K Series



Metro I-Que



Laminated Steel Padlocks

Uncoded Padlocks & Fixture

Mfg	Description	EZ #
MA1UP	1 3/4" wide, 4 pin tumbler padlock	063033
MA1UP LJ	1 3/4" wide, 2 1/2" shackle	063032
MA3UP	1 1/2" wide, 4 pin tumbler padlock	063034
MA3UP LF	1 1/2" wide, 1 1/2" shackle	063035
MA5UP	2" wide, 4 pin tumbler padlock	063036
MA5UP LF	2" wide, 1 1/2" shackle	063037
MA376	UP rekeying tool	065530



UP rekeying tool

Master 1's, 3's and 5's can be keyed to your existing key code in minutes, rather than waiting 2 - 4 weeks for a factory order.

4 Pin Tumbler Laminated Padlocks

1 3/4" wide laminated case. 5/16" steel shackle. Clearances: standard vertical 15/16", horizontal 3/4".

1	EZ #	1	EZ #	1LF (1 1/2" shkl)	EZ #	1MK	EZ #
MA1KD	010148	MA1KA2179	010160	MA1LF KA2001	041431	MA1MK SM24	041422
MA1KA	026911	MA1KA2184	041400	MA1LF KA2004	076089	MA1MK SM935	041426
MA1KAX2027	041397	MA1KA2238	041401	MA1LF KA2065	045517	MA1MK SM936	041427
MA1KA2001	026903	MA1KA2246	010161	MA1LF KA2126	076090	<u>Master Keys</u>	<u>EZ #</u>
MA1KA2002	026904	MA1KA2258	041402	MA1LF KA2885	041432	MA SM24	041429
MA1KA2004	036146	MA1KA2265	076086	<u>1LN (5 3/4" shkl)</u>	<u>EZ #</u>	MA SM935	041474
MA1KA2006	041395	MA1KA2358	076087	MA1LN KA2178	041437	MA SM936	041428
MA1KA2007	071243	MA1KA2359	010166	MA1LN KA2885	041438	<u>Carded</u>	<u>EZ #</u>
MA1KA2016	010150	MA1KA2383	041404	MA1LN KA2004	076095	MA1D	068986
MA1KA2027	041396	MA1KA2396	010167	<u>1LJ (2 1/2" shkl)</u>	<u>EZ #</u>		
MA1KA2029	041398	MA1KA2400	070857	MA1LJ KA2001	041433		
MA1KA2035	010151	MA1KA2402	010168	MA1LJ KA2002	076091		
MA1KA2043	010153	MA1KA2405	079377	MA1LJ KA2004	076092		
MA1KA2076	041399	MA1KA2565	076088	MA1LJ KA2126	026918		
MA1KA2104	062812	MA1KA2569	041417	MA1LJ KA2396	076093		
MA1KA2125	083580	MA1KA2570	041419	MA1LJ KA2402	076094		
MA1KA2126	010157	MA1KA2643	036153	MA1KD LJ	010145		
MA1KA2136	065427	MA1KA2885	041421				



No. 1

1 1/2" wide laminated case. 9/32" steel shackle. Clearances: standard vertical 3/4", horizontal 5/8".

3	EZ #	3	EZ #	3LF (1 1/2" shkl)	EZ #
MA3KD	010361	MA3KA3221	069017	MA3LF KD	026949
MA3KA0356	026923	MA3KA3228	041446	<u>3MK</u>	<u>EZ #</u>
MA3KA0357	041439	MA3KA3252	010373	MA3MK SM732	041450
MA3KA0360	085252	MA3KA3318	041447	<u>Master Keys</u>	<u>EZ #</u>
MA3KA0379	079378	MA3KA3358	076099	MA SM732	041451
MA3KA0412	041440	MA3KA3447	041448	<u>3LH (2" shkl)</u>	<u>EZ #</u>
MA3KA0464	010364	MA3KA3528	085256	MA3LH KA0356	076103
MA3KA0508	041441	MA3KA3591	085253	MA3LH KA0464	041454
MA3KA0536	010366	MA3KA3753	010382	MA3LH KA0536	051770
MA3KA0537	041442	MA3KA3769	036159	MA3LH KA0682	041455
MA3KA0539	079379	MA3KA3795	041449	MA3LH KA3210	069719
MA3KA0713	041443	MA3KA3918	010385	MA3LH KA3303	076104
MA3KA0851	076097	MA3KA3945	076096	MA3LH KA3476	041453
MA3KA3202	076098	<u>3LF (1 1/2" shkl)</u>	<u>EZ #</u>	MA3LHKA3753	026954
MA3KA3210	026925	MA3LF KA0430	076100	MA3LH KD	026955
MA3KA3212	036158	MA3LF KA0536	076101	<u>Carded</u>	<u>EZ #</u>
MA3KA3213	010369	MA3LF KA3210	026940	MA3D	068984
MA3KA3217	041445	MA3LF KA3303	076102		
MA3KA3220	010370	MA3LF KA3753	026947		

Shackle
 LF - 1 1/2"
 LJ - 2 1/2"
 LH - 2"
 LN - 5 3/4"



No. 3

4 Pin Tumbler Laminated Padlocks

2" wide laminated case. 3/8" steel shackle. Clearances: standard vertical 1", horizontal 15/16".

5	EZ #	5	EZ #	5LJ (2 1/2" shkl)	EZ #
MA5KD	010420	MA5KA A518	010429	MA5LJ KA A112	041479
MA5KA	043086	MA5KA A549	041465	MA5LJ KA A383	026969
MA5KA3252	085255	MA5KA A598	071349	MA5LJ KA A473	026971
MA5KA A112	028744	MA5KA A599	041460	MA5LJ KA A545	076107
MA5KA A141	041456	MA5KA A614	026959		
MA5KA A163	041457	MA5KA A626	063975	<u>5MK</u>	<u>EZ #</u>
MA5KA A232	063973	MA5KA A1159	076106	MA5MK SM900	041469
MA5KA A272	010424	MA5KA A1355	041462	MA5MK SM902	041470
MA5KA A292	063974	MA5KA A1384	045546		
MA5KA A297	010425	MA5KA A1981	041463	<u>Master Keys</u>	<u>EZ #</u>
MA5KA A303	076105	MA5KA A1988	041464	MA SM900	041471
MA5KA A383	010426			MA SM902	041472
MA5KA A389	010434	<u>5LF (1 1/2" shkl)</u>	<u>EZ #</u>		
MA5KA A431	079380	MA5LF KA A112	041475		
MA5KA A432	041458	MA5LF KA A473	026965	<u>Carded</u>	<u>EZ #</u>
MA5KA A445	041459	MA5LF KA A480	041478	MA5D	068987
MA5KA A473	010435				



No. 5

Shackle
LF - 1 1/2"
LJ - 2 1/2"

1 1/8" wide laminated case. 3/16" steel shackle. Clearances: standard vertical 9/16", horizontal 1/2".

7	EZ #	7	EZ #	7LJ (2 1/2" shkl)	EZ #
MA7 KD	010508	MA7KA P491	036164	MA7LJ KA P150	076114
MA7KA P104	041483	MA7KA P604	070860	MA7LJ KA P216	076115
MA7KA P150	041485	MA7KA P605	045561	MA7LJ KA P792	041494
MA7KA P164	041486	MA7KA P609	076111	MA7LJ KA P604	070863
MA7KA P176	076108	MA7KA P761	010521		
MA7KA P185	041476	MA7KA P812	010523	<u>7MK</u>	<u>EZ #</u>
MA7KA P225	085254	MA7KA P848	010524	MA7MK SM76	041491
MA7KA P288	076109			<u>Master Key</u>	<u>EZ #</u>
MA7KA P216	041487	<u>7LF (1 1/2" shkl)</u>	<u>EZ #</u>	MA SM76	041492
MA7KA P319	070859	MA7LF KA P605	076112		
MA7KA P393	068999	MA7LF KA P609	076113	<u>Carded</u>	<u>EZ #</u>
MA7KA P423	070861	MA7LF KA P812	041493	MA7D	068983
		MA7LF KA P604	070862		

No. 7



5 Pin Tumbler Laminated Padlocks

15	EZ #	17	EZ #
<i>2 1/2" wide laminated case.</i>		<i>2" wide laminated case.</i>	
<i>1 1/4" shackle clear. 7/16" diam.</i>		<i>1" shackle clear. 7/16" diam.</i>	
MA15KD	010239	MA17KD	010260
MA15KA10N619	010236	MA17KA19T455	010257
MA15KA19N451	010238	MA17KA19T459	026987
MA15KA19N464	041497	MA17KA19T462	041498

No. 15



No. 17



Precision 5 pin tumbler mechanism. Double locking system – exclusive dual steel levers independently lock each shackle leg. Case hardened alloy steel shackle, chrome plated. Cadmium rustproofed. Packed 6 per box.

Breakaway Shackle

Shackle easily shatters by a blow from a hammer or similar tool.

1 3/4" wide case, 9/32" shackle diameter, 13/16" clear.

Mfg # MA500BRK KA197 EZ# 010440



Combination Locks



High Security Locks • Key Blanks

175 Series Combination Padlock

Instantly resettable to open at any personally programmed 4-digit combination. Corrosion-resistant solid brass 2" case & 5/16" thick nickel plated case hardened steel shackle with a 1" vertical & horizontal clearance. Packed 6 per box.

Mfg. #	Desc.	EZ #
MA175D	1" shackle	010273
MA175LHD	2 1/4" shackle	010274
MA177D	1" shrouded shackle	072298
MA178BLK	Die cast black case	073111



Combination Key Lock Box

- Large key storage holds over 5 keys
- 4 dial resettable combination
- Reinforced body & hardened steel shackle

Mfg # MA5400D EZ # 078878
Mfg # MA5401D (wall mount) EZ # 080333



Pin Tumbler Laminated Brass Padlocks

- 4 pin tumbler cylinders • Packed 6 per box
- Dual brass levers independently lock each shackle leg
- Case-hardened steel shackle (No.6 - extra tough alloy)

Mfg. #	Description	EZ #
MA6KA A1158	Keyed Alike	041481
MA6MK SM905	Master Keyed	041482
MASM905	Master Key	041473



No. 6
No. 6 - 2" wide case.
3/8" shackle. Clear: vert 1",
horiz 1/16"

Brass Padlocks

Stylish and strong solid brass lock body. 120 - 3 pin tumbler, 140 - 4 pin tumbler, 150 & 160 - 5 pin tumbler

Mfg. #	Size	EZ #
MA120DKA1A36	3/4" wide	068982
MA140D	1 1/16" wide	068996
MA150D	2" wide	068997
MA160D	2 3/8" wide	068998



Titanium Series Padlocks

- Use of high-tech and extremely strong metal Titanium
- No rust lifetime guarantee • Scratch proof
- Shrouded hardened steel shackle

Mfg. #	Width	Color	EZ #
MA185XD	1 1/16"	Black	072890
MA187XD	2 1/16"	Black	072891



Pro Series Padlocks

Mfg. #	Description	EZ #
MA6835WOBLK	Aluminum body (black)	066759
MA6850WO	Brass rekeyable	067204
MA6851WO	Brass I/C padlock	067206
MA6852WO	Brass KIK Cylinder	066790

WO = Less
Cylinder



6851

1500 Series Combo Padlock

Stainless steel outer case armors heavy wrought steel inner case. Case width 1 7/8". 9/32" shackle dia. Clearances; vertical 3/4", horizontal 13/16". Packed 12 per box. Combined different

Mfg. # MA1500 EZ # 010244



Combo Lock With Key Override

Mfg # MA176 P243 EZ # 081972

Mfg # MA176LH P243
EZ # 082155 (2 1/8" shackle)

Override Key:
Mfg # MA176CRP P243
EZ # 082156



Key Blanks

Pin Tumbler

Mfg. #	Fits Master Locks	EZ #
MA1K	1 thru 6, 11, 77, 33, 34, 35, 36, 37, 39, 475, 425	010149
MA2K	1MK, 3MK, 5MK	010280
MA7K	7, 8, 90, 716, 719	010509
MA9K	9	010553
MA15K	15	010235
MA17K	17	010256
MA19K	19	010275
MA27K	21, 25 & 27 Rekeyables	010321
MA40K	40	010400
MA81KR	81, 82, 50, 1710, 1714	010550
MA81KM	1710MK, 1714MK	010549
MAK101	1 & 3 EX Series	068278
MA130K	130, 140	010195
MA150K	150, 160	010243
MA900K	911	061806
MAK701	7 EX Series	068279

Flat Key Type

MA1718K 1718, 1719 locker locks 010267

Warded Type

MA10K	10	010179
MA22KL	22(left-handed)	010307
MA22KR	22(right-handed)	010308
MA500KL	450, 500(left-handed)	010445
MA500KR	450, 500(right-handed)	010446
MA510K	510, 517, 518	010448

Model No.	A	B	C	Width
6835	1/4"	1 1/16"	25/32"	1 9/16"
6850	3/8"	1 1/2"	29/32"	2"
6851	3/8"	1 1/2"	29/32"	2"
6852	3/8"	1 1/2"	29/32"	2"

Rekeyable Laminated Padlocks

Mfg. #	Description	EZ #
<i>NO. 21 - 1 3/4" wide case, 27K keyway. 5/16" shackle. Clear: vert. 15/16", horiz. 3/4"</i>		
MA21KA	Keyed Alike	010285
MA21KD	Keyed Different	010286
MA21KD LJ	2 1/2" Shackle, Keyed Different	010291
MA21KZ	0 Bitted	026996
MA21LFWO	1 1/2" Shackle, Less Cylinder	010289
MA21LF	1 1/2" Shackle, Keyed Different	041521
MA21LFKA18L643	1 1/2" Shackle, Keyed Alike	080562
MA21LJWO	2 1/2" Shackle, Less Cylinder	010292
MA21LNWO	5 3/4" Shackle, Less Cylinder	010293
MA21WO	Without cylinder	010294
<i>NO. 21W1 - 1K Keyway</i>		
MA21KDW1	Keyed Different	010296
MA21W1KA2337	Keyed Alike	026998
MA21W1KZ	0 Bitted	027001
<i>NO. 25 - 2" wide case. 3/8" shackle. Clear: vert. 1", horiz. 15/16"</i>		
MA25LJ WO	2 1/2" Shackle, without cylinder	041525



Mfg. #	Description	EZ #
<i>NO. 25 Cont.</i>		
MA25WO	Without cylinder	041524
MA25W1KZ	0 Bitted, 1K Keyway	027005
<i>NO. 27 - Plug Extension (required w/1K kwy cyl.)</i>		
Mfg # MA27 0334	EZ # 010320	
<i>NO. 27 - 2" case, 27K cyl. 7/16" shkl. Clear: vert. 1", horiz. 3/4"</i>		
MA27KA10L472	Keyed Alike	027007
MA27KZ	0 Bitted	027008
MA27WO	Without cylinder	010327
MA27W1KZ	0 Bitted, 1K Kwy	027006
<i>NO. 101 - 3 1/4" case, 27K cyl. 5/16" shkl. Clear: vert. 3", horiz. 2 1/4"</i>		
MA101	Keyed Different	010181

Rekeyable Solid Steel Padlocks

Mfg. #	EZ #
<i>1 9/16" wide, Shackle 1 1/16", 5 pin W6000 cyl.</i>	
MA7030KD	070921
MA7030KA10G015	070922
<i>Same As Above With Shrouded Shackle</i>	
MA7035KD	072671
MA7035KA	070775
<i>1 3/4" wide, Shackle 1 3/16", 5 pin W6000 cyl.</i>	
MA7040KD	070923
MA7040KA10G015	070924



Mfg. #	EZ #
<i>1 3/4" wide, Shrouded Shackle 1 3/16", 5 pin W6000 cyl.</i>	
MA7045KD	072672
MA7045KA10G001	070776
<i>2" wide, Shrouded Shackle 1 1/2", 5 pin W6000 cyl.</i>	
MA7050KD	070773
MA7050KA	072673
<i>2 7/8" wide, Shackless, 6 pin W7000 cyl.</i>	
MA6270KD	070925
MA6270KA10G015	070926
<i>Solid Steel Hasp for 6270 Lock</i>	
MA770	070520

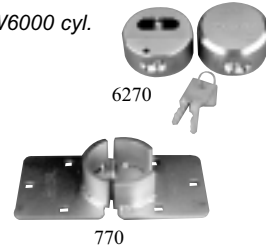

I/C Padlocks

Easy to custom build to exactly match your requirements. Solid steel. WO = without core

<i>1 3/4" wide body, Shackle 1 3/16"</i>	Mfg # MA7041 WO	EZ # 070504
<i>2" wide body, Shackle 1 1/2"</i>	Mfg # MA7051 WO	EZ # 070920



Warded Padlocks

Mfg. #	Description	EZ #
<i>No.22 - 1 1/2" wide case. Shackle 1/4" dia, clear 5/8"</i>		
MA22 KD	Keyed Different	010303
MA22KA280	Keyed Alike	010304
MA22KA343	Keyed Alike	041522
<i>No.10 - 1" wide case. Shackle 5/32" dia, clear 7/16"</i>		
MA10KA23	Keyed Alike	010180



Cylinders for Rekeyable Padlocks

Mfg. #	Description	EZ #	Mfg. #	Description	EZ #
<i>Cylinder used in 21, 25, 27 or 230 padlocks</i>					
MA295KZ W27	0 Bitted, 27K kwy.	010118	MA295KZ W15	0 Bitted, 15K kwy, 5 pin	010112
MA295KA2159W1	Keyed alike, 1K kwy, 4 pin	010107	MA295KZ W17	0 Bitted, 17K kwy, 5 pin	010115
MA295KZ W1	0 Bitted, 1K kwy, 4 pin	010109	MA295W81KZ	0 Bitted, 81K kwy, 5 pin	041539
MA295W1KD	Keyed different, 1K kwy, 4 pin	041538	MA295WP4RT	Restricted kwy	082733
			MA295KA WP4RT	Restricted kwy, Keyed alike	082734
			MA295UN WP4RT	Restricted kwy, uncombined	080775



Hasps

Armor Lock

Exclusive shackle guard, extra resistant to bolt cutters and hacksaws. Patented dual steel locking levers independently lock both shackle legs. 1 9/16" wide laminated steel case; shackle clearances: vert. 15/16", hor. 7/16". Packed 6 per box.

Mfg. #	Description	EZ #
MA37D	Keyed Different	010394
MA37D KA0645	Keyed Alike	027011



Shrouded Padlock

- 2 3/4" wide stainless steel body
- Hardened steel shackle • 4 pin cylinder

Mfg. #	EZ #
MA40KD	010399
MA40KA0452D	038651



Pro Series Aluminum Padlocks

- Ideal for OSHA safety lockout & color coded security programs
- Solid security for harsh environments

Mfg. #	EZ #
MA6835WO RED	067312
MA6835WO YLW	066754
MA6835WO GRN	066769
MA6835WO BLK	066759
MA6835WO BLU	066764
MA6835WO ORJ	066774
MA6835LFWO RED	067836
MA6835LFWO BLU	067840
MA6835LFWO YLW	067837
MA6835LFWO BLK	067841
MA6835LFWO ORJ	067838



- 1 1/8" wide body
- 1/4" shkl dia.
- 1 1/8" shkl clear
- LF = 1 1/2" shkl clear

Door Key Padlock

Uses same key that opens your security doors. Comes without core, easy to custom build to meet your specific requirements. 1 3/4" wide body, 5/16" shkl. dia., 13/16" shkl. clear.

Mfg. # MA7042WO EZ # 070506



Utility Lock

- Modified straight post, enlarged head frustrates attacks, shackle rotates to deflect saw blades
- 5/8" shackle clear., 3/8" shackle diam.
- Precision 4-pin tumbler keyway

Mfg. # MA443KA0709 EZ # 041544



Backpack Padlocks

Set-your-own combination. Ideal for school, at home or work. Rugged die-cast construction.

Mfg. #	EZ #
MA1544DCM Red	068275
MA1545DCM Purple	068276
MA1547DCM Black	073116



Spare Tire Lock

- Solid zinc and steel construction
- Chrome plated for corrosion resistance
- Locks over wheel studs up to 3/8" dia.

Mfg. # MA262DAT EZ # 073302



Hasplocks

Heavy-duty slide bolt; 4 1/2" wrought steel hasp, plus 1 3/4" laminated-steel padlock.

Mfg. # MA475KD EZ # 010415



Trailer Lock Kits

- Receiver lock fits both 3/8" & 1/2" holes
- Coupler lock fits most 1 7/8" & 2" couplers

Mfg. #	Desc.	EZ #
MA3774XDAT	Coupler & 2 rec locks	077474
MA1474DAT	Coupler & rec lock	074953
MA1480DAT	Stainless steel rec lock	074954



Trailer Locks

Protect against theft of unhitched boat, camping, & utility trailers. Powerful enclosure with high security pin tumbler locking mechanism surrounds coupler socket.

Mfg#	Description	EZ #
MA34	Fits most 2" couplers	010391
MA35	Fits most 2" & 2 5/16" Marvel couplers	010392
MA36	Fits most 2" Hadco couplers	010393
MA39KD	Fits most 2" & 1 7/8" Bulldog couplers	068274



Coupler Lock

Chrome-plated, zinc die-cast body with front access keyway for ease of accessibility.

Mfg # MA377DAT EZ # 072755



Coupler Latch Lock

- Armored hardened steel shackle defies cutting
- 3 1/2" laminated steel body for superior strength
- 4-pin tumbler cylinder helps prevent picking

Mfg # MA1471DAT EZ # 080440



Adjustable Coupler Latch Lock

- Fits most coupler latch widths of 3/4", 1" or 2"
- 4-pin tumbler cylinder helps prevent picking

Mfg # MA2847DATSC EZ # 085440



Trailer Hitch Lock

- Hardened receiver pins increase shear strength
- Precision pin tumbler mechanism resists picking

Mfg # MA375DAT EZ # 072757



Trailer Pin Locks

Mfg # MA370DAT EZ # 075145 (1/2" pin)
Mfg # MA371DAT EZ # 075143 (5/8" pin)



Light Weight Chains

3/16" lightweight welded steel chain. Case-hardened, zinc plated. Flexible vinyl protective cover.

Mfg. #	Clearance	EZ #
MA73	3 ft.	027022
MA74	6 ft.	027023



Python Locking Cable

- Adjustable • Infinite locking positions
- Pick, cut & scratch resistant • 3/8" dia cable

Mfg. #	Desc	EZ #
MA8413XDPF	6' Locking cable	076559
MA8401D	Replacement lock	077496
MA8405D	4' cable only	077211
MA8408D	8' cable only	077212
MA8412D	12' cable only	077213
MA8415D	15' cable only	077214
MA8430D	30' cable only	077215
MA8491	Rekeying kit	077216



Security Bar

- Add-on security for entry/patio doors
- Lightweight aircraft grade alum. construction
- Withstands over 1,000 pounds of force
- Fits most hinged doors

Mfg # MA250D EZ # 030451



Safety Lockout

Red vinyl-coated high-tensile steel. Rust resistant. Accepts 6 padlocks up to 1 1/32" shackle diameter.

Mfg # MA420 EZ # 010405



No. 291 Rekeying Parts Kit

Kit contains regular and master pins, springs, assorted locking nuts, retainer plates, assembly tool, key gauge and wrenches. Measures 11 3/4" x 8" x 2" with built-in parts chart.

Mfg # MA291 EZ # 010338



TSA Dial Combo

- Durable metal construction

Mfg # MA4680DBLK (black) EZ # 084660
Mfg # MA4680DNKL (nickel) EZ # 084661



TSA Locking Strap

- 78" webbed strap is adjustable for flexibility

Mfg # MA4682DBLK EZ # 085556



TSA Luggage Lock

- Solid brass body with durable plastic protective cover
- Keyed alike twin pack

Mfg # MA4681TBLK (black) EZ # 085554
Mfg # MA4681TBLR (blue) EZ # 085555
Mfg # MA1224TSABLK (black display) EZ # 085557
Mfg # MA1224TSACOL (color display) EZ # 085558



Steel Cable Lock, Self Coiling

- 6' cable length will accommodate most tires and general applications
- Padlock included has been chosen for corrosion resistance

Mfg # MA613DAT EZ # 075144



Cable Lock, Self Coiling

- Ideal for bikes & skateboards
- Resettable combination

Mfg # MA8168DCP EZ # 068991



Chains and Collars

Mfg. #	Description	EZ #
--------	-------------	------

9" Chains

MA71CS	Lightweight	027018
MA71CH	Heavyweight	027017

Collars

MA71SC8	1/4" dia.	027020
MA71SC9	9/32" dia.	010539
MA71SC10	5/16" dia.	010537
MA71SC12	3/8" dia.	010538
MA71SC14	7/16" dia.	027021



Combination Retractable Cable

- Vinyl coated cable to prevent scratching
- Push-button retraction for easy cable recoiling
- Set your own combination

Mfg # MA4603D EZ # 080127



Street Cuffs

3" cuffs fit motorcycle fork legs or frame. Can be secured to sign post or parking meters.

Mfg # MA8290DPS EZ # 079372



Hasps

Heavy hard-wrought steel, ribbed for maximum strength. Tapered design, with rolled edges to conceal screws and prevent prying. Exclusive pinless hinge for added security. Cadmium rustproofing.

Mfg. #	Description	EZ #
MA702D	2 1/2" Security Hasp	010533
MA703D	3 1/2" Security Hasp	010534
MA704D	4 1/2" Security Hasp	010535
MA706D*	6" Security Hasp	010536

*Body of case-hardened steel



Padlock Eyes

Secure way to attach a padlock, Hard-wrought 1/8" steel, cadmium rust resistant. Width 2 1/8". Hole size 3/4" x 5/8". 6 Pair per box

Mfg.#	Description	EZ #
MA60	Flat	010460
MA60R	Right Angle	010461



Key Gauge

Mfg# MA29 0371 EZ #010329

Weather Tough/High Security Padlocks



Parts & Accessories

WEATHER TOUGH™

- High Security Cylinder with Spool Pins
- Cylinder Dust Cover
- Rekeyable • Hardened Boron Alloy Shackle
- W6000 Keyway • Xenoy Thermoplastic Cover
- Flow Through Debris Channels
- Dual Ball Bearing Locking • Laminated Steel Body

Model No.	A	B	C	Width
6121	5/16"	1 1/8"	7/8"	2 1/8"
6121LJ	5/16"	2 1/2"	7/8"	2 1/8"
6125	3/8"	1 3/8"	7/8"	2 3/8"
6125LJ	3/8"	2 1/2"	7/8"	2 3/8"
6127	7/16"	1 3/8"	7/8"	2 5/8"
6127LH	7/16"	1 7/8"	7/8"	2 5/8"
6421	5/16"	1 1/8"	7/8"	2 1/8"
6621	5/16"	1 1/8"	7/8"	2 1/8"
6627	7/16"	1 3/8"	7/8"	2 5/8"



No. 6121

HIGH SECURITY

- High Security Cylinder with Spool Pins
- Dual Ball Bearing Locking
- Laminated Steel Body / Solid Metal Shroud
- W6000 Keyway • Xenoy Thermoplastic Cover(6300's)
- Hardened Boron Alloy Shackle
- Rekeyable • Hardened Solid Steel Lock(6320)

Model #	A	B	C	Width
6230	7/16"	1 1/8"	7/8"	2 1/2"
6230LH	7/16"	2"	7/8"	2 1/2"

Model #	A	B	C	Width
6321	5/16"	3/4"	7/8"	2 1/8"
6325	3/8"	3/4"	7/8"	2 3/8"
6327	7/16"	3/4"	7/8"	2 5/8"
6721	5/16"	3/4"	7/8"	2 1/8"
6727	7/16"	3/4"	7/8"	2 5/8"

Mfg. # Description EZ #

PRO SERIES SHACKLES

- MA293S6121LJ 2 3/8" Shkl Clear. 010340
 MA293S6121LN 5 5/8" Shkl Clear. 036174
 MA293S6127LJ 2 3/8" Shkl Clear. 060192

PRO SERIES DRIVERS (6600/6700)

- MA298 0626 Lori Driver 030456
 MA298 0627 Medeco Driver 030457
 MA298 0628 Schlage Driver 030458

Mfg. #	Description	EZ #
MA6121KA10G010	KA 10G010	041547
MA6121 KA10G015	KA 10G015	041548
MA6121LJ WO	2 1/2" Sh. W/O Cylinder	036193
MA6121WO	W/O Cylinder	010470
MA6125KA10G020	KA 10G020	041553
MA6125LJ WO	2 1/2" Sh. W/O Cylinder	036194
MA6125WO	W/O Cylinder	010478
MA6127KA10G030	KA 10G030	041554
MA6127WO	W/O Cylinder	010482
MA6127LH WO	1 7/8" Sh. W/O Cylinder	036195
MA6230KA10G040	KA 10G040	041558
MA6230LH WO	2" Sh. W/O Cylinder	041559
MA6230WO	W/O Cylinder	010488
MA6321WO	W/O Cylinder	010493
MA6325WO	W/O Cylinder	010497
MA6327WO	W/O Cylinder	036196
MA6421WO	W/O IC Cylinder	031014
MA6527WO	W/O Cylinder	031018
MA6621WO	W/O KIK Cylinder	031020
MA6627WO	W/O KIK Cylinder	031021
MA6721WO	W/O KIK Cylinder	031022
MA6727WO	W/O KIK Cylinder	031023

PRO SERIES CYLINDERS

MA296KZ W1	4 Pin - 0 Bitted, 1K kwy	010345
MA296 W1	4 Pin - KD, 1K kwy	041541
MA296 W17KZ	5 Pin - 17 kwy, 0 Bitted	036182
MA296 W15KZ	5 Pin - 15 kwy, 0 Bitted	036183
MA296KZ W27	5 Pin - 0 Bitted	043138
MA296KA W12885	4 Pin - KA 2885, 1K kwy	041540
MA296KZ W6000	5 Pin - 0 Bitted	036181
MA296W6000KD	5 Pin - KD	036177
MA296KZ W7000	6 Pin - 0 Bitted	041542
MA296KA10G116W6000	5 Pin -KA10G116	010348
MA296WP4RT	4 pin - Rest.	082737
MA296KA WP4RT	4 pin - Rest., Keyed alike	082738
MA296UN WP4RT	4 pin - Rest., uncomb	080776
MA296WP6RT	6 pin - Rest.	082741
MA296KA WP6RT	6 pin - Rest., Keyed alike	082742
MA296UN WP6RT	6 pin - Rest., uncomb	080777

PRO SERIES CYLINDER PINS - REGULAR

MA1 0360	#0 Cylinder Pins	010124
MA1 0361	#1 Cylinder Pins	010125
MA1 0362	#2 Cylinder Pins	010126
MA1 0363	#3 Cylinder Pins	010127
MA1 0364	#4 Cylinder Pins	010128
MA1 0365	#5 Cylinder Pins	010129
MA1 0366	#6 Cylinder Pins	010130
MA1 0367	#7 Cylinder Pins	010131

PRO SERIES CYLINDER PINS - MASTER

MA1 0391	#1 Master Pins	010134
MA1 0392	#2 Master Pins	010135
MA1 0393	#3 Master Pins	010136
MA1 0394	#4 Master Pins	010137
MA1 0395	#5 Master Pins	010138
MA1 0396	#6 Master Pins	010139
MA1 0397	#7 Master Pins	010140

PRO SERIES CYLINDER PINS & DRIVER TUMBLER SPRINGS

MA1 0368	Non Spool Driver Pins	010132
MA1 0369	Tumbler Springs	010133

PRO SERIES



No. 6127



No. 6327



No. 6421



No. 6621



No. 6230

Mfg. # Pins EZ #

KEY BLANKS

- MA6000B 5 Pin 076991
 MA7000K 6 Pin 010531

Super-Eye Color High Resolution Camera

- 480 TV lines resolution
- AC24V input voltage
- NTSC or PAL system
- Lens sold separately
- 70mm (W) x 58mm (H) x 114mm (D)

Mfg # UKPIH7024H EZ # 077755



High Resolution Color Camera

- 480 TV lines resolution
- AC24V input voltage
- NTSC or PAL system
- Lens sold separately
- 70mm (W) x 58mm (H) x 114mm (D)

Mfg # UKPIH7824 EZ # 077753



Standard Resolution Color Camera

- 380 TV lines resolution
- AC24V input voltage
- NTSC or PAL system
- Lens sold separately
- 70mm (W) x 58mm (H) x 114mm (D)

Mfg # UKPIH7324 EZ # 077754



Economical Color Camera

- 380 TV lines resolution
- AC24V input voltage
- NTSC or PAL system
- Lens sold separately
- 66mm (W) x 58mm (H) x 99.5mm (D)

Mfg # UKPIH72FN EZ # 077751



Vari-Focal Color Camera

- 350 TV lines resolution
- AC24V input voltage
- NTSC or PAL system
- 70mm (W) x 57mm (H) x 112mm (D)

Mfg # UKPIH1324 EZ # 077750



High Resolution B/W Camera

- 600 TV lines resolution
- AC24V input voltage
- EIA or CCIR system
- Lens sold separately
- 70mm (W) x 58mm (H) x 114mm (D)

Mfg # UKPIH7924 EZ # 079686



Vari-Focal Color Mini Dome Camera

- 420 TV lines resolution
- DC12V input voltage
- NTSC system
- 98mm (W) x 112mm (H) x 40.5mm (D)

Mfg # UKPIH162XN EZ # 077748



Fast Dome Camera

- 480 TV lines resolution
- 12VAC input voltage
- NTSC system • 145mm dia

Mfg#	Zoom	EZ #
UKPIH7000NL	17X	077759
UKPIH7600NL	22X	077758



Housing & Mounts

Mfg#	Desc.	EZ #
UKPIH5040SHB	Outside housing	077746
UKPIH510L	Outside wall housing	077757
UKPIH510H	Outside pendant housing	077756
UKPIH500	Camera mount 153mm (H)	077743
UKPIH303B	Wall mount indoor	079601
UKPIH303	Outdoor pan tilt	078856



PIH5040



PIH303



PIH510H



PIH500

Monitors & Lens

Mfg#	Desc.	EZ #
UKPMH217C	Color 17" / 520 TV lines	077738
UKBB50	50 ft BNC RG59U cable	078859
UKBB100	100 ft BNC RG59U cable	078860
UKPSH358D	3.5 - 8mm auto iris	078853
UKPSH358M	3.5 - 8mm manual iris	078854
UKPSH1025D	10 - 25mm auto iris	079044
UKPSH550D	5 - 50 mm auto iris	078855



PMH217

ACSI

1500 Series Electric Locks

UL listed modifications to a wide range of manufacturers locks

Mfg#	Features	EZ #
<i>Corbin Russwin</i>		
EKML22903/05NSA626LC	Fail safe/secure	080445
EKCL33905NZZD626LC	Fail secure	080451
EKCL33903NZZD626LC	Fail safe	080452
<i>Sargent</i>		
EK10G70LL26D	Fail safe	080453
EK10G71LL26D	Fail secure	080454
EKLC8270LNL26D LC	Fail safe	080446
EKLC8271LNL26D LC	Fail secure	080447
<i>Schlage</i>		
EKD80EL LD RHO626 24V	Fail safe	080448
EKD80EU LD RHO626	Fail secure	080449
EKD80EL LD RHO626 12V	Fail safe	080450
EKL9080ELEU L06 626LC	Fail safe/secure	080443
EKL9080EURX L06 626 LC	Fail safe/secure	080444

Fail Safe = Power Lock

Fail Secure = Power Unlock

RX = Request to Exit

All locks are 24VAC/DC except where shown



Alarm Controls

Mag Lock

- 1200 lbs holding force • 10 1/2" x 2 3/4" x 1 1/8"
- 12VDC or 24VDC • Bi-color status LED

Mfg # EH1200LB EZ # 085020



Altronix

Battery Cabinet

- Accommodates up to two 12VDC batteries
- 18 gauge gray cabinet with ample knockouts for convenient access

Mfg # TABC200 EZ # 061323



Accessories

Mfg. #	Desc.	EZ #
TABT12/4	12VDC 4 AMP/HR Battery	060445
TABT126	12VDC 7 AMP/HR Battery	084856
TABT121	12VDC 12AM/HR Battery	084857
TA6062	Multifunction 12/24 VDC Timer	084858
<i>Relay Modules</i>		
TARB1224	12/24 VDC switch selectable operation	061321
TAAL624	6/12/24 VDC Switch, 1.2 AMP cont. supply	061322

Altronix

Fire Alarm Signaling Circuit Power Supplies

- UL listed fire protective signaling
- 12VDC or 24VDC power limited output is switch selectable
- Includes power supply, cabinet, cam lock & transformer

115 VAC, 50/60 hz, .75 amps

Mfg # TAAL400ULX EZ # 060444

1.75 amp continuous supply current at 12/24 VDC

Mfg # TAAL175ULX EZ # 068442

6 amp continuous supply current at 12/24 VDC

Mfg # TAAL600ULPD8 EZ # 084855

2.5 amp continuous supply current, 6/12/24 VDC power limited output

Mfg # TASMP3E EZ # 084893



Bauer Products

Locking Handle

Mfg. # C to C Proj. EZ #

"L" Handles

BAL204R KD 1 1/2" 2 1/4" 004200

BAL204R KA 1 1/2" 2 1/4" 040210

BAL204R KD 1 3/4" 2 1/4" 040211

"T" Handles

BAT301R KD 1 1/2" 2 3/16" 040213

BAT301R KA 1 1/2" 2 3/16" 040214

BAT301R KD 1 3/4" 2 3/16" 004209

BAT301R KA 1 3/4" 2 3/16" 040215



"L" Handle



"T" Handle

Locked Position: Rigid

Bommer

3-Tumbler Lock

- (2) keys. Can be supplied with 210 key changes.
- Lock has steel bolt and case and brass tumblers.

Mfg # BO25389 EZ # 001815



Channellock

4'n 1 Screwdrivers

- For slotted & Phillips head screws

Mfg # CLMX 41 EZ # 040252



Charley-Bar

- Fits all 36" to 48" Sliding Glass doors
- Made of Rust-Proof Sturdy Aluminum Tubing

Mfg# Desc. EZ #

CB16 108C 4 ft. Alum 035237

CB16 108CB 4 ft. Bronze 035238

CBA60 5 ft. Alum 040227

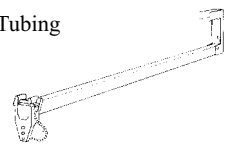

Miscellaneous

Coleman • Command Access • Corby Comb-Cam • CSI • Exit Security

Coleman Wire & Cable

500' Unshielded Wire

18 AWG / 2 conductors / sold by box / gray
Mfg # JO51104 45 09 EZ # 083352



500' Overall Shield Wire

22 AWG / 4 conductors / sold by box / gray
Mfg # JO67001 45 009 EZ # 083354
22 AWG / 6 conductors / sold by box / gray
Mfg # JO67005 45 009 EZ # 084891



500' Plain Coaxial Cable

RG59 / sold by box / black
Mfg # JO92074 45 08 EZ # 083357



500' Plenum Cable

RG59 / Plenum / sold by box / white
Mfg # JO99969 45 01 EZ # 083358

1000' Coax/Video Cable

RG59 / 18 / sold by reel / black
Mfg # JO993253 06 08 EZ # 083355



RG59 / 18 / Plenum / sold by reel / white
Mfg # JO993256 06 01 EZ # 083356

500' Unshielded Plenum

18 AWG / 2 conductors / sold by box / natural
Mfg # JO71902 45 23 EZ # 083353



500' Shielded Plenum

18 AWG / 2 conductors / sold by box / natural
Mfg # JO75902 45 23 EZ # 083613
22 AWG / 4 conductors / sold by box / natural
Mfg # JO75304 45 23 EZ # 083359
22 AWG / 6 conductors / sold by box / natural
Mfg # JO75306 45 23 EZ # 084892



Command Access

Energy Transfer Hinges

• UL Listed • 3 year warranty

Mfg#	Description	EZ #
OAETH4W4540 26D	4 wire - 4.5 x 4.0	071307
OAETH4W4545 26	4 wire - 4.5 x 4.5	083376
OAETH4W4545 26D	4 wire - 4.5 x 4.5	071308
OAETH4W4545 613	4 wire - 4.5 x 4.5	083377



Command Access

Electrified Locks

• 24V • Continuous duty solenoid
• 3 year limited warranty • UL Listed



Mfg#	Description	EZ #
OAL9080EL LB	Storeroom/Fail Safe	060456
OAL9080EU LB	Storeroom/Fail Secure	060459

Combi-Cam

Keyless Solid Metal Cam Lock

• 1,000 possible combos • Replaces any 3/4" keyed lock

Mfg#	Size	EZ #
FJ7850S	5/8"	083282
FJ7850M	7/8"	083283
FJ7850L	1 1/8"	083284



Corby System

• Aluminum cover • Outdoor • Single code pad
• Surface mount • Night light • 2.75" X 4.5"

Mfg # CY7022 EZ # 061594



CSI

4" x 6" Alarm Siren

• 30 watts 120 DB • Weatherproof ABS Plastic
• Dual tone warbling & steady
• Cable concealed in base • Operates on 6 to 12VDC



Mfg # CXSA12RP EZ # 060764

2 Station Wired Door Answering System

• 2 station indoor/outdoor remote intercom/chime tone
• Door release button for electric strikes - optional
• Hands free remote conversation
• 4 "C" batteries or optional battery eliminator

Mfg#	Description	EZ #
CXWI150D	2 Station	060456
CXPSW2	12 VDC Power Supply	060459
CXWI DR	2-wire door remote station	060458



Exit Security

• Easy to Use • 3 Easy Steps to Install
• Emergency - Sensitive • Hardware Provided

Mfg#	Description	EZ #
EISB107010	White Ring Bolt	040409
EISB107020	Gold Ring Bolt	040410



Exit Security

Heavy Duty Security Bar

Ideal for many commercial exits regardless of door size. Designed for single or double doors, in swinging or out-swinging functions. Features a unique, patented, hook-on/lift-off operation that is easy to use and emergency sensitive.



Construction: Major parts are manufactured of 16-gauge square steel tubing (1" and 1 1/4"); "L" bolts are 6 1/2" inches in length, with zinc chromate finish.

Mfg#	Description	EZ #
EISB010036	Outswing, Single 36" Door	040401
EISB010042	Outswing, Single 42" Door	040402
EISB010048	Outswing, Single 48" Door	040406
EISB010072	Outswing, Double 36" Doors	040408
EISB P1 1015	Extra Long "L" Bolts	044448

File Guard™

Ideal for turning an ordinary filing cabinet into a security cabinet. Steel channel bar and steel mounting bolts ensure maximum security. Pushbutton combination lock provides quick, easy and convenient day to day use.



File GuardBar

Mfg#	Length	Model	EZ #
ILFG14A	4 drawers	Pushbutton	067550
ILF2504A	4 drawers	Standard	035648
ILF2505A	5 drawers	Standard	035649
ILF2572A	2 drawers	Self-storing	040614
ILF2574A	4 drawers	Self-storing	040615
ILF2582A KD	2 drawers	Built in lock	040616
ILF2584A KD	4 drawers	Built in lock	040617
ILF2585A KD	5 drawers	Built in lock	040618



Pushbutton model

Glynn Johnson

HL6 Push/Pull Latch

- Fits Gov't. #161 cutout, Non-handed
- No fusible link to fail
- Can be mounted in any of six positions
- UL Listed for all labeled doors, metal or wood



Mfg # GJHL6 2 3/4 626	Hospital Latch	EZ # 028299
Mfg # GJHL PART10077	5" backset Only	EZ # 064120
Mfg # GJHL PART10065	2 3/4" backset Only	EZ # 068957

Grobet

6" File Handle

Mfg # GR37.784 EZ # 030329



Grobet

Round File

Gradually tapered. Cut & workable to the point, used to enlarge a hole or round off a radius. Files with chisel cuts are used for rapid removal of material and etched cuts for fine finishing.

Mfg#	Length	Dia.	Cut	EZ #
GR31.290	6"	1/4"	#2 coarse	040491
GR31.292 1	6"	1/4"	#4 fine	035559
GR31.297	8"	5/16"	#2 coarse	040494
GR31.298	8"	5/16"	#4 fine	040492

Pippin File

Tapered in width and thickness. Combines cross sections of the round with crossing file & having the edge of a knife file for finishing the junction of two different curved surfaces. Also used for opening slots when a "V" shape is required.

Mfg#	Length	Dia.	Thick.	Cut	EZ #
GR31.268	6"	25/64"	3/64"	#2 coarse	030327
GR31.269 1	6"	25/64"	3/64"	#4 fine	035562

Warding File

• Length: 6" • Width: 5/8" • Thickness: 5/64" • Bastard cut

Mfg # GR32.469 EZ # 030328

H.B. Ives

Door Holder

Mfg#	Finish	EZ #
IVFS455 3AL	Brass	040844
IVSPFS455 27	Aluminum	026566



Resilient, non-marring rubber tip.

Decorative Surface Bolts

Stainless steel tension spring prevents rod disengagement from guide & ensures tension to hold bolt in desired position.

Mfg#	Finish	Length	EZ #
IV43B3 4	Polished Brass	4"	040828
IV43B3 6	Polished Brass	6"	040829



Throw: 1"

available with universal and angle strikes

Concealed Screw Surface Bolts

- 40 has tension spring to hold bolt in desired position. Permanent stop prevents rod disengagement from track.
- 144 has half round rod of 11/16"
- 40 comes with universal & mortise strikes.
- 144 comes with universal & angle strikes.

Mfg#	Finish	Length	EZ #
IV40B3 4	Polished Brass	4"	040826
IV40PA28 4	Aluminum	4"	040827
IV144B3 12	Polished Brass	12"	040835



Miscellaneous

H.B. Ives • Hickok • Hardsteal • Iron
 IONIT • Jacknob • Lawrence • Linear

H.B. Ives

Elbow Catch

Made from cast brass. Ideal for inactive leaf of cabinet doors.

Mfg # IVSP2A3 EZ #026544



Door Viewers

180° viewer

Mfg # IV698B26D EZ # 046857



UL Listed Extension Flush Bolts

- For use on all types of labeled metal fire doors not exceeding 3 hrs. fire rating and 8 ft. in height.
- Extruded brass plate, cast slide, steel bolt head
- Polished Brass Finish, Strike included
- 6 3/4" x 1 1/4" face plate

Mfg#	Dia	Rod Length	Throw	EZ #
IVFB457 3	1/2"	12"	3/4"	040846



Heavy Duty Surface Bolts

- Fully concealed mounting prevents vandalism
- Constructed of heavy duty steel
- Universal top strike permits use of bolts with inswinging and outswinging doors.

Mfg#	Finish	Throw	Length	EZ #
IVSB1630T 2G	Zinc	1"	8"	040840



Hickok

For complete coverage on ALL Ford/Lincoln-Mercury and Mazda vehicles equipped with transponder keys.

Mfg # NGS XL CAN (8008LXLC)



Hardsteal

- Used by Avis, Budget, National, Thrifty Enterprise and other car rental companies
- Qualifies for insurance discount in most states.
- Easy Installation - no special tools or skills required

Mfg#	Description	EZ #
HLCA	Collar on column w/hole for shift	040002
HLCB	Collar on column w/o hole for shift	040003



Iron Products

Lock Box for Mortise Locks

Mfg#	Description	EZ #
IP1 1/4	Fits Marks T22AC	040770
IP20	One sided box 12GA	040771

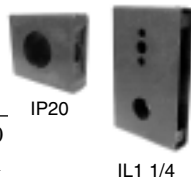

IONIT

- Record for days, weeks - even months!
- Digitally records images directly on a computer hard drive
- Instant access - type in data and time, retrieve images instantly.
- Patented compression capabilities provide incredibly clear video that won't degenerate over time.

Mfg#	Description	EZ #
IOIPP N4 200	Pro + 4 Ch. DVR Sys.	080618
IOIPP N8 200	Pro + 8 Ch. DVR Sys.	080619
IOIPP16 240	15 FPS Pro + 16 Ch. DVR Sys.	080907



Jacknob

One-Way Screw Remover

- Set of 3 different sizes
- For use on all Screw Sizes

Mfg # JK8905 EZ # 040867



Lawrence Hardware

8" padlock barrel bolt

Mfg # LFCD1403S ZN8 EZ # 084996



Linear

Hand Held Transmitters

- Dimensions: 4.2"L x 1.6"W x .8"H
- Belt clip and pocket clip included
- Power: Two 3V DL-2032 lithium batteries included
- DXT-21 one channel: top or front; DXT-23 four channels: top, left, right, or left and right simultaneously (fail safe mode)

Mfg. #	Description	EZ #
LEDXT21	Two-Button, One-Channel	060299
LEDXT23	Three-Button, Four-Channel	060300



Digital Hand Held Transmitters

- 1 channel • 256 code combinations by dip switch
- Test/operate LED • Optional visor mounting

Mfg. #	Description	EZ #
LED22A	One-Channel	041028



One-Channel Receivers

- Wide range of output options • Form "C" relay output
- 256 code combinations by dip switch
- 11-24 VDC or 12-16 VAC input power

Mfg. #	Description	EZ #
LED67	Four-Second On Time	041027



Linear

Receivers

- 32 transmitter capacity • Selectable output modes
- Quick-learn programming • 11-17 VDC, 12-16 AC
- RF activity indicator • Form-C relay output
- Low battery sensing (LEDXR702 only)



12 volts required

Mfg. #	Channels	EZ #
LEDXR701	1	060144
LEDXR702	2	060298

DX Series Mini Transmitters

- Two CR 1616, CR1620, or DL1620 3V lithium cells supplied
- 2.25"L x 1.25"W x .48"H • Snap-action key ring
- Operating Frequency: 315 MHz



Mfg. #	Description	EZ #
LEDXT41	One-Button, One-Channel	060296
LEDXT42	Two-Button, Three-Channel	083779

Motion Detector

- 4.4"L x 3.2"W x .1.75"H • Passive Infrared
- Power: One 9V alkaline battery (included)
- Measured range: 700 ft in open air, 1 quadrant
500 ft min. in open air (4 quadrant test)



Mfg. # LEDXT54 EZ # 069862

Lockwood



8" Surface bolt - fire rated

Mfg # LM402VP32D EZ # 077944

LOK-Safe

Mfg#	Description	EZ #
AI1072	2 per cd (allen wrench type)	040036
AI1076	6 per cd (allen wrench type)	040039

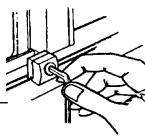

McKinney

5 Knuckle Full Mortise Hinges

- Standard weight 4 1/2" x 4 1/2" hinges
- T2714: plain bearing, TA2714: ball bearing

Mfg. #	Finish	EZ #
KTT2714P	Primed for painting	072022
KTT2714 26D	Dull Chrome	072032
KTT2714 605	Bright Brass	078381
KTTA2714 US3	Bright Brass	072880
KTTA2714 26D	Dull Chrome	072878
KTTA2714 26D NRP	Dull Chrome	072035



T2714



NRP - Non removable pin Sold per box (3 hinges per box) TA2714

McKinney

Half Surface Aluminum Continuous Hinge



83" hinge for retro-fit applications.
Heavy for high to medium frequency doors up to 540 lbs.

Mfg # KTMCK54HD CLEAR EZ # 076117

Spring Hinges

- Full mortise single acting standard weight



Mfg. #	EZ #
KT1502 4.5 x 4.5 26D	083967
KT1502 4.5 x 4.5 10B	083968
KT1502 4.5 x 4.0 26D	072883
KT1502 4.5 x 4.0 10B	083969

Majestic

- 1 offset needle .025"
- 1 straight needle .025"
- 1 straight needle .035" • Tension wrench



Mfg # MJLPG1 EZ # 011016

Mitsubishi



- 24 hour real time with audio
- Up to 1280 hours of time lapse
- Jog/shuttle dial for ease of use • Triple density recording

Mfg # XUHS1280U EZ # 084872

Multi-Lock

- Inner slide bar with locking lug hinge at each drawer opening when in the locked position.
- Simple upward motion of inner slide bar releases all lock points and allows the built-in spring loaded hinge to swing the bar clear of all drawer openings.
- Installs in a matter of minutes, without opening the cabinet or disturbing its contents. Installs with either blind rivets provided or sheet metal screws.
- Chrome plated with the inner slide bar coated in red acrylic enamel. Hinges and locking lugs are 16-gauge steel.



Mfg. #	Length	Drawers	EZ #
MUML1	11"	1	011169
MUML2	21 1/2"	2	011170
MUML3	33 1/2"	3	011171
MUML4	44"	4	011172
MUML5	56"	5	011173

MMF Industries

Mfg#	Cap.	EZ #
QX201-9010-03	10	039965
QX201-9030-03	30	039966
QX201-9060-A03	60	039967
QX201-9110-03	110	039968



OEM

File Cabinet Bars

Mfg#	Drawers	EZ #
OEFCB1	1	036437
OEFCB2	2	036438
OEFCB3	3	036439
OEFCB4	4	036440
OEFCB5	5	036441



OSI

Black Print Thermal Paper (6 rolls/bx)

Mfg # OMWP106 EZ # 011530



Cylindrical Locks

Directly replaces existing 2 1/8" cylindrical locksets. Includes OMNILOCK control module, mechanical key bypass with 2 keys, Lithium Power-Pak, dead-latch, strike plate, mounting tool, and instruction sheet.

Mfg #	Desc	EZ #
OM250TL K26D	Key In Knob	011533
OM250TL L26D	Lever	011535



OMBR-23 Replacement Power Pak

Lithium Power Pak for all OMNILOCK control modules. Expected lifetime: 5 years/50,000 cycles

Mfg# OMOMBR23 EZ # 011529



Opti Visor

Precision binocular headband magnifier which permits unrestricted user efficiency while reducing eye strain. Leaves both hands free and allows three dimensional vision.



Mfg #	Desc.	EZ #
DEDA5	2 1/2 time magnification	040302
DEDA7	2 3/4 time magnification	040305
DELPI	Additional 2 1/2 time attachment	040306

PDQ

Grade 2 SP Series Levers

- Doors: 1 3/8" to 2" thick standard.
- Backset: 2 3/4" standard,
- Front: 2 1/4" x 1 1/8" • Rose: 3 3/8" diameter
- Strike: 4 7/8" x 1 1/4" • Latchbolt: 1/2" throw



Mfg#	Description	EZ #
PDSP115PHL26D L/C	Storeroom	041775
PDSP115RPHL26D LIC	Storeroom	041776
PDSP116PHL3 L/C	Entry	041777
PDSP116PHL10B L/C	Entry	041778
PDSP116RPHL26D LIC	Entry	041781
PDSP116PHL26D L/C	Entry	041780
PDSP126PHL26D	Passage	041785
PDSP148PHL26D L/C	Classroom	041787
PDSP176PHL26D	Privacy	041790

• R - 1/C Core • L/C - Less Cylinder • LIC - 1/C Prep Less Core

Grade 2 SV Series Knobs

- For Doors: 1 3/8" to 1 3/4" thick.
- Backset: 2 3/4" standard
- Front: 2 1/4" x 1 1/8" • L/C - Less Cylinder



Mfg#	Description	EZ #
PDSV115CQ32D L/C ASA	Storeroom	026223
PDSV116CQ320 L/C ASA	Entry	072821
PDSV148CQ32D L/C ASA	Classroom	026226

Grade 2 SP Series Replacement Deadlatch

Mfg#	Description	EZ #
PDV21900 711 26D	2 3/4" B.S. Deadlatch	041793

Precision Hardware

Mfg #	Hand	Function/Desc	EZ #
PR0810N27LHRB	LHRB	Exit Only	027307
PR0810T10RHRB	RHRB	Exit Only	041809
PR0810T27LHRB	LHRB	Exit Only	041810
PR0810T27RHRB	RHRB	Exit Only	041811
PR17H US10	N/A	Pull Plate Trim	062891
PR17HT US26D	N/A	Thumb Piece Trim	062892
PR39KA 10	N/A	Knob Trim	041803
PR39KA26D	N/A	Knob Trim	063561

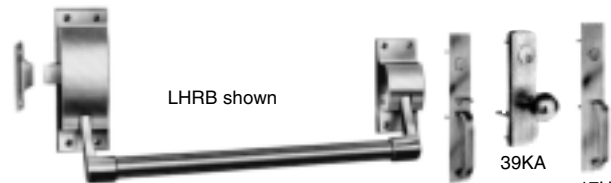

Order Trim Separately

* Cylinder is not furnished

17HT

39KA

17H

Permavault

Counter Drop

- Body Dimensions: 6" x 6" x 12"
- Chute Opening: 3/4" x 4 3/4"
- Chute Height: 1" • 14 lbs.

Mfg# PVPRO1206CHM EZ # 041800



Programmed Marketing

File Cabinet Locks

- Keyway: Hudson H20
- Pin tumbler, 2 ringed keys
- 100 key changes, keyed alike
- Key number on face • Finish: Clear chromate.
- Operation: 90° key turn, key removable in locked position only. Furnished with screw.

Mfg#	Length	EZ #
PMFC103 KD	2"	005510
PMFC103 KA F26	2"	027323
PMFC5046 KD	1 7/16"	041815
PMFC6046 KA561	1 3/4"	027330
PMFC6046 KD	1 3/4"	041816
PMFC6046B KD	1 3/4"	041817

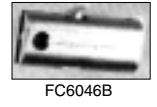
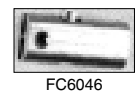
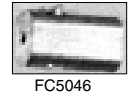

Truck Body Lock

- 5 Brass wafers • 2 ringed keys
- Keyway: Hudson H07 • 50 key changes
- Keyed alike in pairs
- Spring loaded plunger returns to original position when pressure is removed from plunger
- Key removable locked and unlocked positions.
- 90° turn allows plunger to be depressed for striking action.

Mfg # PMGDC2329 EZ # 005515



Pin Tumbler Mail Box Locks

- 90° key removable in locked position only
- Finish: Brushed chrome or Satin Brass
- Keyway: Hudson H20, H21

Mfg#	EZ #
PMPT812 26D 4 CAMS	041813
PMPT812 4 4 CAMS	041814



Key Blanks

Mfg#	Desc.	EZ #	Mfg#	Desc.	EZ #
PMH01	5 wafer	005518	PMH03	5 wafer	041818
PMH01L	6 wafer	005520	PMH20	5 pin	005543
PMH02	5 wafer	005522	PMH21	5 pin	005544
PMH02L	6 wafer	027332			

Programmed Marketing

Indiana Cash Drawer Lock

- XW2823: 45° key turn XW2873: 180° key turn
- US14 finish • Keyed different

Mfg#	Desc.	EZ #
PMXW2833	Springbolt	074249
PMXW2873	Deadbolt	077939



Sliding Door Lock

- Key removable locked & unlocked position.
- Deadbolt locked by pushing plunger in and released with key
- 2 ringed keys • 5 Brass wafers • Fin: Bright nickel plated
- Kwy: Hudson H01 (Ilco L1054B)

Mfg#	EZ #
PM1001KA HL302	027326
PM1001KD	027327



RCI

Low Profile Electric Strike

- Field Selectable • Lock mode/voltage
- 1 1/4" x 4 7/8" • Aluminum/Wood Frames.

Mfg # RCL6504 32D EZ # 081001



Revere

Accessories

Mfg#	Desc.	EZ #
RARPS115	Mini Siren 12VDC	069866
RARSTA	Amber strobe light 12VDC	069865



Transformers

Mfg#	Volts	EZ #
RART1220SL	12 VAC	065405
RART1620	16.5 VAC	065406
RART2440SL	24 VAC	065407
RARTD24/5RT	24 VDC	076264
RARTD12/5RT	12 VDC	076265



Rockaway

Insulated Security Chests

Cash Box with removable tray.
 Size: 4" H x 11" W x 7 3/4" D
 Mfg # RM14313 EZ # 041888

Almond Insulated.
 Size: 8 3/8" H x 12 1/2" W x 4 1/2" D
 Mfg # RM14314 EZ # 041889



Rytan

• **RYP-13** - Lock Pick Instrument Sets - 11 Instruments - 1 case, 1- RBPX-5, 1- RLPX-10, 1- RLPX-11, 1- RLPX-12, 1- RLPX-14, 1- RSTW-3, 1- RTR-11, 1- RTR-13, 1- RP-14, 1- REZ-2, and 1- REZ-7

• **RY36** - Cylinder Removal Tool for Kwikset - pops cylinders out of the popular "400" series Knob locks in a jiffy.

• **RY57** - Plug Spinner - will turn the cylinder plug past the shear line without causing the lock to relock.

• **RY100 030** - Cutter for standard cylinder keys and Medeco, fits RY100

Mfg#	EZ #		
RYRYP13	041922		RY57
RYRY36	041923		
RYRY57	041925		
RY10030	011838	RY10030	RY36

Replacement blades: Mfg # RYRY57RB EZ # 046073

Safety Technology

Entrance Alert

This unit mounts on any door to automatically alert you with a chime whenever the door is opened. Transmitter requires a 6 VDC battery (included).

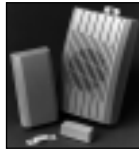

Mfg # TSRC3260 EZ # 060767

Mini Bopper Stopper

Clear shield for use with Alarm Lock's T3 Trilogly Series. Helps protect against direct rain and water.



Mfg # TSSTI6516 EZ # 071126

Doorbell Chime

No expensive wiring. Simply mount transmitter/button outside and plug receiver in any in door electrical outlet. Requires two 3 volt lithium batteries (included).

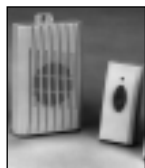

Mfg # TSRC3250 EZ # 060766

SDC

1571 Series EmLock

- 1200 lbs. Holding Force • BHMA Grade 2
- U.L. Listed • 11" x 2 3/4" x 1 1/2"
- Dual Voltage 12/24VDC
- Single EmLock for outswing door

Mfg # ZR1571V EZ # 066572
Mfg # ZR1571X EZ # 072256

V = Alum. X = Dark Bronze Anodized



SDC

1585 Series EmLock

- 650 lbs. Holding Force
- BHMA Grade 3 • U.L. Listed
- Single EmLock for outswing door
- Dual Voltage 12/24VDC • 8 1/2" x 1 7/8" x 1 3/16"

Mfg # ZR1585 12/24VDC EZ # 069856



550 Switch Bar

Designed to release any magnetic lock with minimal pressure applied to bar and requires no prior knowledge or effort for free egress. Fits standard door opening of 36", 42" and 48" (with stops no greater than 5/8") without cutting. For dual fail-safe redundant operation; alarm shunt or monitoring output.

Mfg #	EZ #	Finish
ZRMSB550 2V36	069085	Clear anodized
ZRMSB550 2V48	069086	Clear anodized
ZRMSB550 2Y36	069871	Black anodized
ZRMSB550 2Y48	069872	Black anodized
ZRMSB550 2 605 36	069873	Bright brass, clear coated

2 = Two separate SPDT switches



Accessories

Mfg #	EZ #	Finish
ZRPT2	069087	Armored Door Loop
ZR422REU	069092	Momentary exit button
ZR702U6	072724	6 amp key switch mom SPDT



Sentry

Hinge Pins

Mfg#	Description	EZ #
ZN1185	10/24 Thread	043089
ZN1186	12/24 Thread	042049

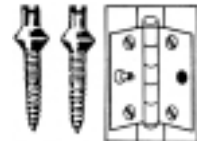

Sieveking Products

Squeeze Play

- Forms the mortise or indentation necessary for installing knob locks and deadbolts in hollow metal doors.
- No door bridges, rivets, screws or extra parts to buy.
- No Cutting, cuts installation time by 2/3rds.

Mfg # SP900 EZ # 013360

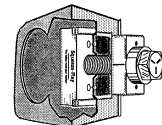

Silent Witness

- Alarm Duration: length of triggering event or latched instant or 30 second delay.
- Digital Video Recorder/Camera: records in a non-volatile memory, can store 1140 still pictures/1 hour 35 minutes of video
- Video Motion Detection: controlled by internal digital signal processor



- Operates in temperatures of 13° F to 122° F
- 5" W x 4" H x 4.5"D • Weights 2.2 lbs
- 1 year warranty

Mfg # WHWC40R EZ # 071131

Slide Guard (Miwa)

Secure patio doors, home windows, pickup truck and RV windows, or cases and cabinets with sliding doors. Easy to use and install, no tools are required.

WR = WR3 keyway.



Mfg#	Description	EZ #
IWSLGKB	Miwa key blank	063976
IWFG406KB	V series key blank	085268
IWSLGZ14KD	Zee bracket show case lock	063527
IWVSLGZ14KA	Zee bracket show case lock	085267
IWSLGO14KD	Original show case lock	063525
IWVSLGO14KA	Original show case lock	085266
IWNOH10XWR	Patio lock (dark bronze)	073416
IWNOH32XWR	Patio lock (stainless steel)	069044
IWNOHWXWR	Patio lock (white)	073417

Southwest Security Products

- Looks exactly like the real product because it was remanufactured from an original container.
- Designed with seamless screw-off top/bottom.
- Protects jewelry, cash and other valuables

Mfg#	Can Safe	EZ #
XP30002C	Rave Hairspray	078883
XP30004C	Desenex	078884
XP40005C	Liquid Wrench	078886
XP10001C	Ajax	078879
XP10006C	BonAmi	078881
XP30001C	Curex	078882
XP51003C	Dr. Pepper	078888
XP51008C	7UP	078889
XP51009C	A&W Root Beer	078890
XP40007C	Puncture Seal	078887



SRS Sales

Filing Cabinet Lock Kits

- Packed in convenient poly bag
- Complete set - ready to install
- 10 coded key changes
- Replaces original manufacturer's model

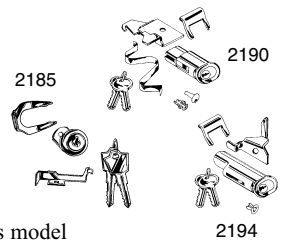

Mfg#	Description	EZ #
SV2151KA 31	Signore Style	072678
SV2176KA 11	Global LK26 Style	072677
SV2185	F28 Style (Hon)	004529
SV2185KA 3	Same as above but KA	067891
SV2190	F26 Style (Hon)	004531
SV2190KA 9	Same as above but KA	004532
SV2190CYL ONLY KA #9	F26 Style	062821
SV2194	Anderson Hickey Style	004533
SV2194KA 8	Same as above but KA	067892
SV2197KA 1	Anderson Hickey 15500	072676

T Handle

- Extra deep hub base for more universal fit
- Reduces need for shiming

Mfg. # SV2205 EZ # 079381



Stanley Works

Mfg#	Description	EZ #
ZY908 6	6" T-hinge	076026
ZYSP917 4.5	4.5" safety hasp	076027
ZYSP1078 4	4" barrel bolt	076028



Sterling

1068 Sliding Door Lock

Patented, positive action design with lock cylinder geared directly to the tongue. 1/2 turn of key locks or unlocks. Fits doors 3/4" to 1 3/4" thick. Two keys supplied.

Mfg. # STCD1068 3KA1001 EZ # 013538



1064 Folding Door Lock

Positive locking action. Only one 3/4" hole needed in one door. Strike is mounted on back side of opposite panel or on striking jamb. Key can be removed in either locked or unlocked position. Fits doors 3/4" up to 1 3/8" thick.

Mfg# STCD1064 3KA1001 EZ # 013534



Super Lube

Multi-purpose synthetic lubricant containing SYNCOLON®. Outperforms conventional petroleum based greases and oils

Mfg. #	Desc	EZ #
US21030	3 oz teflon grease tube	067452
US31040	6 oz aerosol lube can	067453
US31110	11 oz aerosol lube can	067454
US51010	1/4 oz oiler pen	067455
USSCC11016	12 oz dry lube	067457
US21010	1/2 oz grease tube	067450



Tri-Flow

The superior lubricant with a unique formulation of premium oils, penetration and protection ingredients, extreme pressure additives and Teflon.

Mfg. #	Desc.	EZ #
TF20009	4 oz.	013649
TF20006	12 oz.	013648



Tripp-Lite

High Performance Inverter

Provides up to 200% of its rated output for 10 sec. Ideal for fully equipped service vehicle.

Mfg#	Description	EZ #
TTPV2000FC	2000 Watt Power Inverter	073409
TT430133 FUSE	40 Amp Fuse	061414



Watchguard

2062 Series Hi-Security Patio Bolt

Designed for optimum sliding patio door security, comprises an extra tough steel bolt which can be locked into position. Comes with steel keeper to secure hinged doors.

Mfg. #	Color	EZ #
WG206211	Silver	029606
WG206212	Bronze	029605
WG206217	Black	042228



Weslock

Keying Kits and Key Blanks

- Keying kit for re-keying Weslock cylinders including master keyed cylinders

Mfg#	Description	EZ #
WS00101	Keying Kit	042293
WS12344	Key blanks (50)	014175



Weslock

- Limited lifetime warranty • Grade III Classification
- Weslock keyway • 5-pin cylinder
- Adjusts to door thickness from 1 3/8" to 2"
- Fits doors prepared with 2 1/8" cross hole & 1" edge hole
- Adjustable bolt with removable faceplate

Mfg#	Desc	EZ #
WS371AB KA3	Sgl Cyl	042294
WS371 3KA3	Sgl Cyl	042295
WS372AB KA3	Dbl Cyl	042296
WS372 3KA3	Dbl Cyl	042297



Latch

Backset - adjustable, 600 Series

Mfg # WS12721 05 4 EZ # 042302

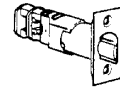

600 Series Cylindrical Locksets

- Limited lifetime mechanical warranty
- Panic-proof keylocks - one turn of interior knob unlocks and opens door
- Adjustable latches with removable faceplate
- 5-pin cylinder • AB - Antique, ELE -Elegant
- Fits doors prepared with 2 1/8" cross bore & 1" edge hole
- Adjusts to door thickness from 1 3/8" to 1 3/4"
- Meets ANSI A 156.2 Grade II cylindrical lock standards

Mfg # WS640ELE AB K2 EZ # 042298



XL Lock

202 & 208



Mail Box Lock

- 201-205 - slight difference in cam travel
- 202 - 5/8" length cam, 208 - 7/8" cam • 812 - 5 cams

Mfg#	Desc.	EZ #
XLLB PT 812 26D	5 cams	042305
XL201A	Old Jensen / All Perma Bolt	014253
XL202C	Old Dura Steel	014251
XL205D	New Jensen	042303
XL208B	New Dura Steel	042304

Young Brothers Stamp Works

Letter Sets (27 Characters)

Mfg. #	Size	EZ #
YB02271	3/32"	027693
YB03271	1/8"	027694



LETTER SET

Figure Sets (9 Characters)

Mfg. #	Size	EZ #
YB02091	3/32"	027691
YB03091	1/8"	027692



FIGURE Set

Made with .95 percent carbon tool steel. Heat treated. Made in the U.S.A.

Surface Vertical Rod Device

Monarch XX-V surface vertical rod devices are used when two point latching is required

- Reversibility: Are easily reversed in the field. • Function: Rim device has all functions built in. Trim sold separately .
- Strikes: 4163 strike is surface applied, 2130 strike is mortised into floor. • Sizes: 3' x 7' standard. .
- Doors: 1 ¼" thick standard. • Latchbolts: 3/4" throw at top, 1/2" throw at bottom.
- Projection: 5" maximum, 4" dogged. • Mounting Height: 40 ¼" horizontal CL to finish floor recommended.
- ANSI: Certified ANSI A156.3-2001 Grade 1 standards.
- Dogging: 1/2" turn cam standard. Cylinder dogging available, (on special order) specify CD prefix.



Mfg. #	Fin.	EZ #
MNXXVIT27 LESS TRIM 32D	32D	041644



XX Series Rim Device

The XX-R Series Rim Device is produced to meet the demanding requirement for high traffic installations. This device is a single point, rim type latch with the traditional crossbar design.

- Hand: Field Reversible. • Functions: All functions built into "BA" (basic assembly).
- Latchbolt: 3/4" throw. • Crossbar: 1" O.D., brass, bronze, stainless steel.
- Stock Size: 3' 0"
- Dogging Feature: 1/2" turn cam. • Strikes: 570 adjustable strike standard.
- Projection: 5" maximum; 4" dogged. • Doors: 1 3/4" thick, wood or metal.
- Chassis & Working Parts: Chassis is pressure die cast aluminum with heavy wrought, forged, investment cast and sintered metal parts. • Arms: Forged brass, aluminum and investment cast stainless steel.
- ANSI: Certified ANSI A 156.3-2001 Grade 1 standards.

Mfg#	Length	EZ #
MNXXRBAS32D	3' 0"	041643

Trim & Parts

Mfg. #	Description	EZ #
MN1445APOLLO 32D	Apollo Pull Plate	041638
MN1446R 32D	Thumb Trim (less cylinder)	041639
MN1446MV 32D	Thumb turn trim f/XXV	073790
MN2402KIL NL MAL	KIL night latch	077404
MN2412KIK NL MAL	KIK night latch	077405
MN2789	Dogging key	041640
MN560 26D	Rim strike for LSPD911R	041635
MN565 M13	Surface strike for XXR	041636
MN565 26D	Surface strike for XXR	027184
MN571 10B	Dbl. door strike for XXR/V	041637
MN571 26D	Dbl. door strike for XXR/V	036396
MN942530 10B	Ext. rod 12" Oil rubbed bronze	011126
MN942530 28	Ext. rod 12" Aluminum	011127



All trims stocked less cylinder.





Deadbolts

Mfg. #	EZ #	Mfg. #	EZ #	Mfg. #	EZ #
<i>Single Cylinder (keyed)</i>		<i>Double Cylinder (keyed)</i>		<i>Single Cylinder Tailpiece</i>	
JN248S HD1 3L HRC	081898	JN248S HD2 3L HRC	081906	JNCP KIKS LT	082698
JN248S HD1 5A HRC	081899	JN248S HD2 5A HRC	081907	JNPYCCTKIDSH (Schlage)	085210
JN248S HD1 10B HRC	081901	JN248S HD2 10B HRC	081908	<i>Double Cylinder Tailpiece</i>	
JN248S HD1 26D HRC	081900	JN248S HD2 26D HRC	081909	JNCP KIKS DC	082699
<i>Single Cylinder (sub-assembled)</i>		<i>Double Cylinder (sub-assembled)</i>		JNPYCCTKIDSHD (Schlage) 085211	
JN206S HD1 3L HRC S	081902	JN206S HD2 3L HRC S	081911	<i>Single Cylinder Door Package (3 1/4")</i>	
JN206S HD1 5A HRC S	081904	JN206S HD2 5A HRC S	081912	JNLP HD THICK HD1	081929
JN206S HD1 10B HRC S	081903	JN206S HD2 10B HRC S	081910	<i>Double Cylinder Door Package (3 1/4")</i>	
JN206S HD1 26D HRC S	081905	JN206S HD2 26D HRC S	081913	JNLP HD THICK HD2	081930



C Series Padlocks

Mfg. #	Desc.	EZ #
JN248S C08P 1	Keyed, 3/8" dia. shkl, 7/8" clear	081916
JN206S C08P 1S	Sub-assembled, 3/8" dia. shkl, 7/8" clear	081917
JN248S C10P 1	Keyed, 3/8" dia. shkl, 1 1/4" clear	081918
JN206S C10P 1S	Sub-assembled, 3/8" dia. shkl, 1 1/4" clear	081919
JN248S C13P1	Keyed, 1/2" dia. shkl, 1 1/2" clear	081920
JN206S C13P 1S	Sub-assembled, 1/2" dia. shkl, 1 1/2" clear	081921
JN248S C13P1SPS	Sub-assembled with padlock protector, 1/2" dia. shkl, 1 1/2" clear	085158



C Series Accessories

Mfg. #	Shackles	EZ #
JNPL C08P SHAC2	2" for C08	081934
JNPL C08P SHAC3	4" for C08	081935
JNPL C10P SHAC2	2.5" for C10	081936
JNPL C10P SHAC3	4" for C10	081937
JNPL C13P SHAC2	2.25" for C13	081938
JNPL C13P SHAC3	4" for C13	081939
Mfg. #	Protectors	EZ #
JNSP10P	for C10	082701
JNSP13P	for C13	082702



All C-Series Padlocks are made with a hardened steel body shell, and a hardened steel shackle.

G Series Padlocks

Mfg. #	EZ #	Mfg. #	EZ #
<i>5/16" Dia. Shackle</i>		<i>3/8" Dia. Shackle</i>	
JN248S G47S	084150	JN248S G55S	084152
JN248S G47PS	084151	JN248S G55PS	084153
JN206S G47S	083775	JN206S G55S	083776
JN206S G47PS	084148	JN206S G55PS	084149



The Steel Plated Brass Body has a high resistance to corrosion, and is manufactured with drainage holes to Resist Freezing. The Hardened Boron Alloy Shackle will withstand various attempts at forced entry.

All padlocks - sub assembled, PS = Protected Shackle

T Series Hockey Puck Padlocks

Mfg. #	Desc.	EZ #
JN248S TR100	Keyed	081914
JN206S TR100S	Sub-assembled	081915



T Series Round Padlocks

Mfg. #	Shackle	EZ #
JN248S TSR25S	1" clearance	085159
JN248S TSR50S	2" clearance	085160



Patented High Security Key Control
All round padlocks - sub assembled

E Series Extra Heavy Duty Padlocks

Made with hardened Boron Alloy

Mfg. #	Shackle	EZ #
JN248S E11L1S	1 1/4" clearance	085161
JN248S E14L1S	1 1/2" clearance	085162



E Series Sliding Bolt Configuration

Made with hardened Boron Alloy

Mfg. #	Bolt	EZ #
JN248S SBE11S	7/16", .79" clear.	085163





Mortise Cylinders

Mfg. #	EZ #
<i>1" Mort. Cyl w/AR cam</i>	
JN248S MOR0 03	081866
JN248S MOR0 26D	081867
JN248S MOR0 10B	081868
<i>1" Mort. Cyl w/AR cam (sub-assembled)</i>	
JN206S MOR0 03S	081869
JN206S MOR0 26D S	081870
JN206S MOR0 10B S	081871
<i>1 1/8" Mort. Cyl w/STD cam</i>	
JN248S MOR1 03	081872
JN248S MOR1 26D	081873
JN248S MOR1 10B	081874
<i>1 1/8" Mort. Cyl w/STD cam (sub-assembled)</i>	
JN206S MOR1 03S	081875
JN206S MOR1 26D S	081876
JN206S MOR1 10B S	081881
<i>1 1/8" Mort. Cyl w/STD cam</i>	
JN248S MOR2 03	081882
JN248S MOR2 26D	081883
JN248S MOR2 10B	081884
<i>1 1/8" Mort. Cyl w/STD cam (sub-assembled)</i>	
JN206S MOR2 03S	081885
JN206S MOR2 26D S	081886
JN206S MOR2 10B S	081887



Rim Cylinders

Mfg. #	EZ #
<i>1 1/8" Rim Cylinder</i>	
JN248S RIM 03 VT	081888
JN248S RIM 26D VT	081889
JN248S RIM 10B VT	081890
<i>1 1/8" Rim Cylinder (sub-assembled)</i>	
JN206S RIM 03 VT S	081891
JN206S RIM 26D VT S	081892
JN206S RIM 10B VT S	081893
<i>Schlage/Arrow KIK Cylinder</i>	
JN248S KIKS 03 F	081894
JN248S KIKS 26D F	081895
<i>Schlage/Arrow KIK Cylinder (sub-assembled)</i>	
JN206S KIKS 03 F S	081896
JN206S KIKS 26D F S	081897

VT = Vertical Tailpiece



KIK Cylinders

Mfg. #	EZ #
<i>Schlage/Arrow KIK Cylinder</i>	
JN248S KIKS 03 F	081894
JN248S KIKS 26D F	081895
<i>Schlage/Arrow KIK Cylinder (sub-assembled)</i>	
JN206S KIKS 03 F S	081896
JN206S KIKS 26D F S	081897



Cams

Mfg. #	Cam	EZ #
JNCP MOR CAM1	Adams Rite	081922
JNCP MOR CAM2	Yale	081923
JNCP MOR CAM3	Russwin	081924
JNCP MOR CAM4	Falcon	081925
JNCP MOR CAM5	Lockwood	081926
JNCP MOR CAM7	Schlage	081927
JNCP MOR CAM8	Sargent	081928

Misc. Parts

Mfg. #	Desc.	EZ #
JNCP KIK L DISK	For KIK lazy cam	082697
JNCP INTDISK1	Int. master disk 1	081941
JNCP INTDISK2	Int. master disk 2	081942
JNCP INTDISK3	Int. master disk 3	081943
JNCP INTDISK4	Int. master disk 4	081944
JNCP EXTDISK1	Ext. master disk 1	081945
JNCP EXTDISK2	Ext. master disk 2	081946
JNCP EXTDISK3	Ext. master disk 3	081947
JNCP SOLDISK1	Solid master disk 1	081948
JNCP SOLDISK2	Solid master disk 2	081949
JNCP SOLDISK3	Solid master disk 3	081950
JNLP HD RINGEXT3	Ext. ring for 1 3/8" door	081931
JNLP HD RINGEXT5A	Ext. ring for 1 3/8" door	081932
JNLP HD RINGEXT26D	Ext. ring for 1 3/8" door	081932

Kits, Cutters & Pins

Mfg. #	Desc.	EZ #
JNCP SIDE PIN	Side pin (nickle silver)	081951
JNCP TOP SPRING STD	Top spring (standard)	081952
JNCP TOP SPRING KIK	Top spring (for KIK)	081953
JNCP TOP PIN STD	Top pin (standard)	081940
JNKM CUTTER	Key machine cutter	082700
JNKEYMACH COMP	Compact key machine	081879
JN248S KEY	Nylon head stamped cut key	081877
JN248S CARD	Key blank order card	081878
JN248S CARD2K	Order card with 2 cut keys	085553
JNLT PINKIT MAST	200 Master pin kit	081880
JNLT CYLKIT	Cylinder maintenance kit	081865

Plug Pins (internal & external)

Mfg. #	EZ #	Mfg. #	EZ #
JNCP INT0	082631	JNCP EXTZ	082637
JNCP INT1	082632	JNCP EXTA	082638
JNCP INT2	082633	JNCP EXTB	082639
JNCP INT3	082634	JNCP EXTC	082640
JNCP INT4	082635	JNCP EXTD	082641
JNCP INT5	082636		



Series 1600 Door Closers

- Multi-Sized: 1601 - Adjustable size 3 thru 6, *1601BF - Adjustable size 1 thru 4, 1602 - 1605 - Fixed Sizes
- Industry Leader - used on aluminum entry doors and other commercial applications. • ANSI A156.4 Grade 1
- Three-way Installation - regular arm, parallel arm or top jamb from standard carton.
- Non-Handed • Independent Adjustable Sweep Speed / Latch Speed. • Made in USA
- Adjustable Backcheck - standard on all 1600 series closers • 10 year limited warranty

* Conforms to opening force requirements of the Americans with Disabilities Act (ADA)

Mfg. #	Size	EZ #	Mfg. #	Size	EZ #
<i>Fixed Size</i>			<i>Adjustable</i>		
NO1603BC 313	3	011413	NO1601BF AL	1-4	011407
NO1603BCAL	3	041697	NO1601BF313	1-4	011408
NO1604H BC AL	4	041699	NO1601AL	3-6	011406
NO1604BC AL	4	011418	NO1601 313	3-6	011411
NO1604BC 313	4	011419	NO1601H AL	3-6	011409
NO1605BC AL	5	011425	NO1601H313	3-6	011410
NO1605BC 313	5	011426			

AL - Alum 313 - Duro H - Hold Open Arm BC - Backcheck BF - Barrier Free

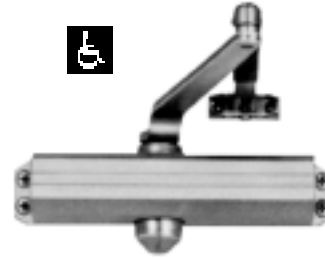

Sex Nut & Bolt

Mfg # NO20 0040 0407AL EZ # 041695

Series 8301 / 8501 Multi-Size Full Feature Closers

- Non Handed: Installs on either hand of door • Adjustable Sweep And Latch Speeds: Separate valves to adjust each speed
- 8301: Slim style molded cover • 8501: Full molded cover. • Projection: 2 1/8" from door • UL listed • 10 year limited warranty
- Three-way Installation – standard closer can be installed regular, parallel arm or top Jamb. • Made in the USA

Mfg. #	Fin.	EZ #
NO8301BF DA AL	AL	011435
NO8301BF DA313	313	041701
NO8301ALUM	AL	011434
NO8301DKB	Dark Bronze	011439
NO8501BF AL	AL	065218
NO8501BF US3	US3	065217

BF - Barrier Free • DA - Delayed Action



Series 8301



Series 8501

7500 Barrier Free

- Power adjust closer, adjustable sizes 1 thru 4. Heaviest duty multi-size closer.
- Non-Handed: Installs on either hand of door. • 10-year limited warranty
- Tri-Style: Standard closer can be installed regular, parallel or top jamb.
- Narrow Projection: projects just 2 1/8" from door.
- Meets ADA requirements • ANSI A117.1 • UL listed • Made in the USA

Mfg# NO7500BF AL SNB EZ# 068085

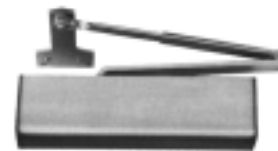

Series 78-B/D Traditional Surface Closers

- Adjustable Spring Power - clock coil spring adjusts through a wide range of power. Power ranges B through D.
- Adjustable Sweep / Latch Speeds - adjustable with 1/8" hex key control valve
- ANSI A156.4 Grade 3 • UL Listed • 10 year limited warranty • Made in the U.S.A.

Mfg. #	Fin.	EZ #
NO78B/D AL RA	AL	041696





Features:

- Complete lockset
- Stand-alone, battery operated lock; no need for expensive wiring
- Unique LifeSafety cylinder - a recodeable, emergency-only override
- Auxiliary latch and case hardened, steel deadbolt with full 1-inch throw, 3/4" latch
- 3-hour UL fire rating for maximum security and safety
- Stainless steel keypad
- All electronics and batteries mounted in inner escutcheon on secure side of door
- Extremely robust, high quality brass escutcheon on secure side of door
- Monitored LifeSafety cylinder, deadbolt, latch and auxiliary latch to detect door position
- Keycard read upon removal ensuring that keycards are not left in the lock
- Different cylinder options: ASSA, MEDCO, SIGNATURE
- ADA compliant

<u>Mfg#</u>	<u>EZ #</u>
JHVCP6055 LH 26D	084044
JHVCP6055 RH 26D	084045

Knob Sets

2 1/4" brass knob set, solid brass with double set screws and straight spindle. (20TPI) Packed one pair in display box.

PH2600 3	Brass plated	EZ # 011557
PH2600 26D	Chrome plated	EZ # 011556



Spindles

Mfg #	Description	EZ #
PH44 20 4	4" straight	027335
PH44 20 4PH	9/32" square x 4 3/4" long, 3 pin holes one side	029760
PH44 20 4TP	9/32" square x 4" long, tapped holes 10/24	041819
PH44 20 5TP	9/32" square x 5" long, tapped holes 10/24	041820
PH45 16	9/32" square x 4 3/4" long	041821
PH45 16 S	9/32" square x 4 3/4" long, two 3/8" solid centers	041822
PH45 20 1/2SPH	9/32" square x 4 3/4" long, one 3/8" solid center 3 pin holes one side	041827
PH45 20C	9/32" square x 4 3/4" long, one 3/8" solid center	041823
PH45 20P	9/32" square x 4 3/4" long with stop pin	041824
PH45 20R	9/32" square x 4 3/4" long, two 3/8" removable centers, swivel	041825
PH45 20RTP	9/32" square x 4 3/4" long, two 3/8" removable centers with tapped holes 10-24	041826
PH46 20 2-5/8	2 5/8" long, 2 piece sectional	027340
PH452032	9/32" square x 4 3/4" long, 3/8" solid center one side, 3 pin holes one side	011565



44-20-4



44-20-4PH



44-20-4TP & 5TP



45-16



45-16-S



45-20-1/2SPH



46-20-2 5/8



45-20-R



45-20-C



45-20-32



45-20-RTP



45-20-P

Replacement Parts

Mfg #	Description	EZ #
PH198 3	Round scar plate 3 1/16"	051920
PH2000 3	Brass escutcheon plate 7" x 2 1/4" With bit key hole	011550
PH2001 3	Brass escutcheon plate 7" x 2 1/4" No key hole	011551
PH206 3	2 1/4" dia. rose	027342
PH208 3	3" dia. rose	011555
PH76 3	Oval thumb turn with square tailpiece	011570
PH76 26D	Oval thumb turn with square tailpiece	027344
PH87 3	Passage Latch	027346



2000



76



198



87

Slide Lock Tool

Two tools in one. Opens both horizontal locking devices and vertical buttons.

Mfg # POA001 EZ # 028159



Gas Cap Key

Use this tool to open almost any locked gas cap. Use like a rocker pick.

Mfg # POA004 EZ # 043046



Astro Tool

Opens the Chevy Astro Van and several other GM cars. The hook and reach make this tool extremely useful.

Mfg # POA007 EZ # 041829



Vent Window Mini Set

Operate the vent windows on car, truck, and van doors. Contains 2 tools.

Mfg # POA014 EZ # 043024

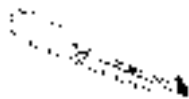

Toyota Tool

Perfect for opening various Toyotas with the metal boxes guarding the bell crank.

Mfg # POA021 EZ # 043053



E-Z Jim

Designed to open a wide variety of foreign and domestic vehicles. Made of stainless steel.

Mfg # POA025 EZ # 043054



Button Finger Tool

The original MCOT modified to operate vertical button cars.

Mfg # POA037 EZ # 029452



Honda Tool

Used to open all Hondas and a number of other foreign and domestic vehicles.

Mfg # POA038 EZ # 043055

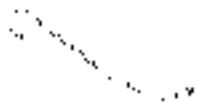

Double Slide Tool

Short reach for narrow doors combined with reverse tip for reaching under horizontal rods.

Mfg # POA039 EZ # 043056

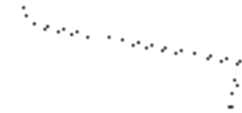

Behind the Glass Tool

This tool solves the problem of gaining access to horizontal rods located above & behind the glass.

Mfg # POA041 EZ # 043058

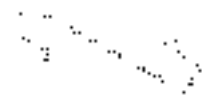

Long Reach Tool

Allows you to reach inside to an activator on the opposite side of the car. Extends up to 76".

Mfg # POA042 EZ # 061514

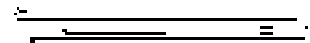

Double Sided Wedge

Made of high impact plastic. Different height on each side.

Mfg # POA060 EZ # 041830



Rubber Wedge

Made of heavy-duty non-marking high grade rubber.

POA061 EZ # 043059



Euro Strip

Flexible tools allows you to by-pass doors on Mercedes, BMW & Volvo.

Mfg # POA085 EZ # 043061



Loop-D-Loop Tool

Fed in under the window, the "loop" is fixed around the straight or mushroom style button head and pulled tight, then lifted up to unlock. Double ended.

Mfg # POA045 EZ # 064615

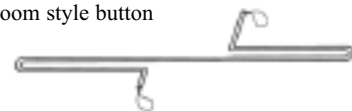

Camry / Lexus Tool

One end of the tool opens the Toyota Camry, the other end offers entry into the rear door of the Lexus LS 400 sedan.

Mfg # POA044 EZ # 064614

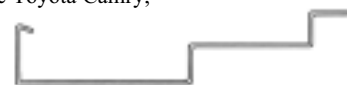



Car Opening Kits

Lock & Safe Scope

Throws a strong beam of light, great for reading wafers & safe work. Comes with 3 tips, carrying case, batteries and bulb.



Mfg # POLT1202 EZ # 011624

Wand w/6v Bulb

6v Light Probe

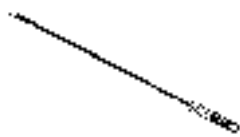

Mfg # POAL3000 EZ # 043018

Multi-Car Opening Tools

AO34 is narrow and goes under the window. AO35 is for wide door panels and cars where you push or pull. AO36, the longest MCOT, allows maximum reach. Use on GM & other products.



Mfg # POAO34 EZ # 025956

Mfg # POAO35 EZ # 025957

Mfg # POAO36 EZ # 029184

The best car opening lights ever made. Made from machined aluminum with black powder coat finish.



Broad Spectrum Light

Bright Two-AA Cell Hardbody. (Uses Broad Spectrum Bulb)

Mfg # POAL10500 EZ # 043017

Krypton Light

Brighter! 3-AA Cell Hardbody. (Uses Krypton Bulb)

Mfg # POAL15500 EZ # 041828



Replacement Bulbs

Spectrum

Mfg # POAL12100 EZ # 043021

Krypton

Mfg # POAL12110 EZ # 028161

6V Halogen

Mfg # POAL12120 EZ # 043022

12V Halogen

Mfg # POAL12130 EZ # 043023



Gun Lock

The only gun lock offering "instant access" as one of the three levels of security.

Mfg # POGL100KA EZ # 070806

Mfg # POGL100KD EZ # 070334



Economy Car Opening Kit

A great starter kit. Two Slim Jim's & two wire tools. Vinyl pouch and Mini Car Entry manual included.

Mfg # POAK75 EZ # 043016

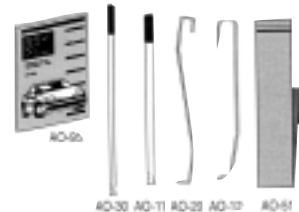

The Pro Kit

A basic kit with the 10 most requested tools. 8" vinyl pouch included.

Mfg # POAK04 EZ # 027869

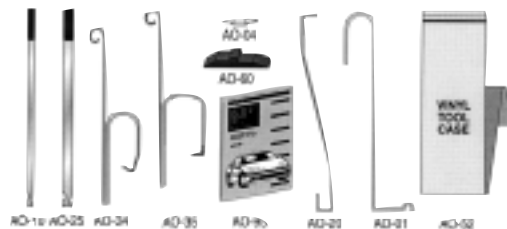

Auto Premium Kit

14 of our best sellers combined into a money-saving kit. This kit will allow you to open 98% of the cars in our Auto Opening Manuals. Features a heavy duty cloth pouch with custom compartment for each tool.

Mfg # POAK92 EZ # 043015

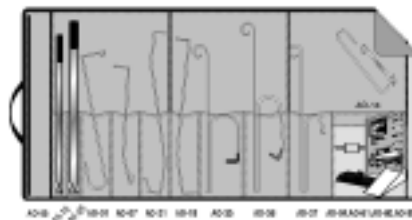

Super Probe Light System

6 Volt Components
Use your own Makita™ battery for power

Mfg # POAL3900

EZ # 043020

(Battery Not Included)

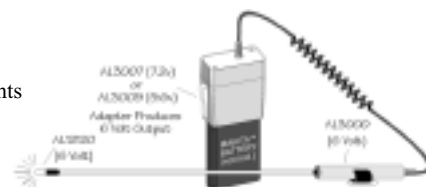

Dispatch Book

Service Call Dispatch Book. Make it easy to track your service calls for dispatch & billing. 3-copy NCR. (one copy for dispatcher, one for service tech, and retain permanent copy in the book) 200 tickets per book.

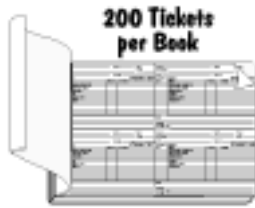

Mfg # POLT430 EZ # 011628

KD Series Key Decoders

Mfg. #	Desc.	EZ #
POKD01	Schlage, Kwikset, Weiser, Weslock	011609
POKD03	GM, Ford, Ford 10 Cut and Chrysler	011611



KD01



KD03

Impressioning Tool

Makes impressioning faster and easier. Maintains a true centerline and grips the key so it can't slip. Works so well, it'll make your Vise Grip obsolete.

Mfg # POLT700
EZ # 043029

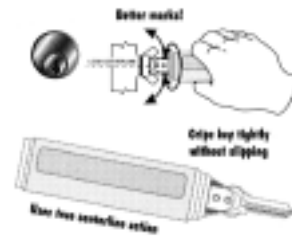

Cap Clincher

Provides quick replacement of GM and other auto lock caps. Simply place the cap in the tool, position the lock, and squeeze to clinch the cap into place. Will not scratch the surface of the cap.

Mfg # POLT740
EZ # 043030

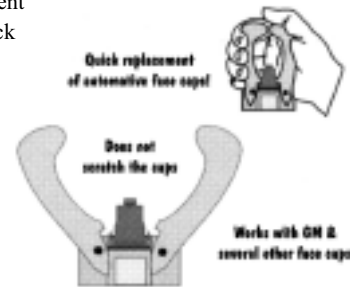

Butter Bits

Do you drill safes?

You know drilling hardplate is difficult, and if you don't have the proper tools it may be impossible. Even if you have the right tools, penetrating a safe effectively requires a level of skill and patience that not all locksmiths can develop. Now the new Butter Bits are changing safe work forever.

What is a Butter Bit?

Pro-Lok has been working with an English manufacturer of safe bits to develop this unique bit which is both fast and durable. The key to this bit's success is the special tip design. This tip uses a unique negative rake angle and a shortened chisel edge that increases its effectiveness and reduces tip failure.

Mfg. #	Desc.	EZ #
POSB01	3/16" x 3 1/2"	043062
POSB02	3/16" x 6"	043063
POSB05	1/4" x 4"	043043
POSB06	1/4" x 6"	043044
POSB11	3/16" x 5"	043033
POSB12	3/16" x 8"	043034
POSB15	3/8" x 5"	043035
POSB16	3/8" x 8"	043036
POSB17	3/8" x 12"	043037
POSB20	1/2" x 6"	043038
POSB21	1/2" x 12"	043039

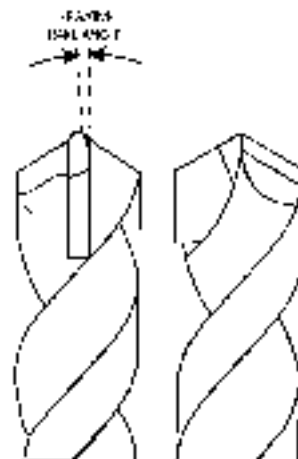
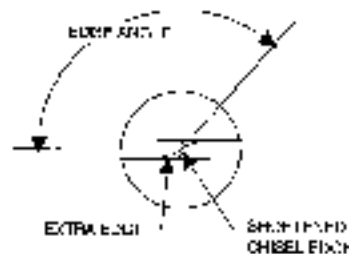

8000 Series - 12 VDC F/Sliding Doors

Features:

- Easy to install
- Holding force - Up to max 650 lbs
- Voltage - 12 VDC
- Fail Safe - Releases instantly when power is discontinued
- Silent Operation
- Reversible - non handed
- Excellent for very busy doors
- Limited Warranty - 5 years
- Magnet Size - 9" x 1 1/2" x 1 3/16"



Mfg # RF8000 12VDC EZ # 061365

8005 Series - 12/24 VDC Single Door Mini Lock

Features:

- Easy to install
- Holding force - Up to max 650 lbs
- Voltage - 12 VDC / 24 VDC field selectable
- Fail Safe - Releases instantly when power is discontinued
- Current Draw - 415 mA at 12 VDC / 215 mA at 24 VDC
- Limited Warranty - 5 years
- No residual magnetism • UL Listed
- Magnet Size - 10" x 1 5/8" x 1"
- Mounting hardware included with unit



Smaller Version
Of 8011-LC Model



Mfg # RF8005 12/24VDC EZ # 061367

8011 Series - 12/24 VDC Single Door Lock

Features:

- Easy to install
- Low current draw
- Holding force - Up to max 1300 lbs
- Voltage - 12 VDC / 24 VDC field selectable
- Fail Safe - Releases instantly when power is discontinued
- Limited Warranty - 5 years
- No residual magnetism • UL Listed
- Magnet Size - 10 1/2" x 2 5/8" x 1 5/8"



Mfg # RF8011LC 12/24VDC EZ # 041862

Magnet with terminal block

Mfg # RF8011LC 20993 EZ # 076085

Double Door

Features:

- Holding force - Up to max 1500 lbs per door
- Voltage - 12 VDC / 24 VDC • Field adjustable
- Fail Safe - Releases instantly when power is discontinued
- Self Aligning - Armature plate (door portion) accommodates all arcs of door swing
- Limited Warranty - 5 years • UL Listed
- Magnet Size - 21" x 2 5/8" x 1 5/8"

Mfg # RF8022 002 EZ # 060922



Magnetic Door Holder

- Holding force 50 lbs
- Fail alarm: will release upon activation of fire alarm or other emergency
- Brushed stainless steel housing



Mfg#	EZ #
RF8910 24VAC/VDC	072264

Angle Brackets for Magnets

- Non-Handed
- For Magnet 8011
- 1" x 1 1/2" x 5/16"



Mfg#	EZ #
RF21021 28 BRACKET	061686

Z Brackets for Inswing and Outswing Doors

- Z-Bracket, adjustable, Aluminum
- L-Bracket for Magnet, Aluminum
- All hardware included for mounting

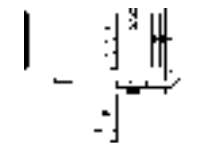

Mfg#	EZ #
RF21031	041887

Filler Plates for Magnets

- Screws for mounting
- Non-handed • Filler plate for 8011
- 1/2" x 3/4"

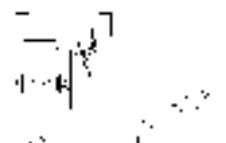

Mfg#	EZ #
RF21001	041886



1509 Series

- For wood, aluminum or hollow metal jambs
- Strike Opening - 5/8" x 1 3/8" • Voltage - 12 or 24 VDC
- Limited Warranty - 3 years • Fail Secure • Reversible - non-handed

Mfg#	Voltage	EZ #
RF1509 05 28	12 VAC or 12VDC	041852
RF1509 08 28	24VAC or 24VDC	041853



High Security Strikes For Mortise Locks

- Standard voltage 12 or 24, VAC or VDC
- Limited Warranty - 3 years
- Stainless steel ANSI size faceplate
- Handed, not reversible
- 05 - 12AC /12DC 08 - 24AC/24DC

Mfg#	Desc	EZ #
RF1430 08 RH32D	Fail-Secure, Schlage, Sargent & Yale	075511
RF1430 08 LH32D	Fail-Secure, Schlage, Sargent & Yale	075512
RF1440 08 RH32D	Fail-Secure, All other mort locks	075513
RF1440 08 LH32D	Fail-Secure, All other mort locks	075514
RF3430 05 RH US28	Fail-Safe, Schlage, Sargent & Yale	075524
RF3430 05 LH US28	Fail-Safe, Schlage, Sargent & Yale	075525
RF3440 05 RH US28	Fail-Safe, All other mort locks	075526
RF3440 05 LH US28	Fail-Safe, All other mort locks	075527



1704 Series

- For wood, aluminum or hollow metal jambs
- Fail Secure • Intermittent duty • Strike Depth - 1 1/2"
- Reversible - non-handed • Limited Warranty - 3 years
- Heavy Duty Construction • Voltage - 12 or 24 VDC or VAC

Mfg#	Voltage	EZ #
RF1704 04 28	12VAC / 12VDC	060205
RF1704 07 28	24VAC / 24VDC	061362



1702 Series

- For wood, aluminum or hollow metal jambs
- Fail Secure • Intermittent duty
- Reversible - non-handed • Heavy Duty Construction
- Limited Warranty - 3 years • Faceplate - 1 1/4" x 4 7/8"

Mfg#	Voltage	EZ #
RF1702 04 10B	12VAC / 12VDC	067019
RF1702 04 28	12VAC / 12VDC	061361
RF1702 07 10B	24VAC / 24VDC	067020
RF1702 07 28	24VAC / 24VDC	011723



1960 Series

- For Commercial and Residential, New or Retrofit Uses
- Fail Secure • Reversible - non-Handed
- Limited Warranty - 3 years • Tamper Strength 1500 lbs
- Heavy Duty & Tamper Resistant Design

Mfg#	Voltage	EZ #
RF1690 05 32D	12VAC / 12VDC	085442



2402 Series

- Stainless steel ANSI size faceplate
- Corrosion - resistant case and moving parts
- Tamper strength test - 1500 lbs
- Limited Warranty - 3 years • Use with mortise and cylindrical locksets
- Reversible - non-handed • Fail-Safe/Fail-Secure • Faceplate - 1 1/4" x 4 7/8"

Mfg#	Voltage	EZ #
RF2402 05 32D	12VAC / 12VDC	074354



Miscellaneous Parts

Mfg#	Desc.	EZ #
RF1005	Rectifier converts AC to DC for 8 to 24 volts, max .5 amps	011714
RF1010	Switch with momentary Form C contact. White color.	041849
RF9000	Buzzer, electronic, for 7-30 VDC	041876
RF9102 12D	1 amp power supply	077243
RF9102 24D	2 amp power supply	077244

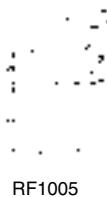

Stand-Alone Controller

- 500 user capacity
- Mullion style
- Fully potted
- Backlit keys
- Limited lifetime warranty

Pin Only

Mfg # FUAC G43 EZ # 085011

Pin Prox

Mfg # FUAC G44 EZ # 085010



PIN-Only Controllers

- Vandal & weather resistant
- 500 pin user capacity

Mullion Housing

Mfg # FUAC S43 EZ # 085014

Single Gang Box

Mfg # FUAC T43 EZ # 085013



Stand-Alone Indoor Pin Controller

- 500 user capacity
- Internal buzzer
- Built in keypad for PIN code entry

Mfg # FUAC D31 EZ # 085017



Stand-Alone Outdoor Pin / Prox Controller

- Vandal & weather resistant
- Built in keypad for PIN code entry
- Limited lifetime warranty
- 500 user capacity

Mfg # FUAC Q44 EZ # 085012



Single Door Controller

- 8 units can be connected in network with a PC
- Supports 2 secured monitored readers
- 2400 user capacity
- Includes software

Mfg # FUAC 115 EZ # 085015

Cable for PC connection

Mfg # FUMD 14 EZ # 085016





6100 Series Motorized Electronic Combination Locks

Powered by two 9-volt alkaline batteries spring loaded, motor driven deadbolt as a 6730 lock bolt. Battery life tests exceed 5,000 openings, a signal alerts you of a low battery. In 20 seconds you can easily change a combination directly from the keypad. The master code permits you to quickly assign, change, and delete user codes; can also open the safe's door. For added protection the 6100 Series locks have a programmable time delay which can be used at your option. Completely retrofittable.

Mfg#	Description	EZ#
SG6120 303	Electronic Combo (black) 1 to 9 minute time delay (batteries not incl.)	025766
SG6120 305	Electronic Combo (silver) 1 to 9 minute time delay	025767
SG6120 502	Electronic Lock Only 1 to 9 minute time delay (master code cap.)	062789
SG6120 016	Electronic Key Pad Only (for 6120 & 6121)	062788
SG6123 501	Electronic Lock Only 99 minute time delay (3 level code access)	062790



Biometric Keypad

- Designed for quick, easy retrofit upgrade on many existing S & G electronic locks
- Top-mounted fingerprint reader is easily accessible
- Quickly open a safe in total darkness, if necessary
- Front-mounted LCD guides you through enrolling fingerprints and programming
- Enroll up to 11 different fingerprints
- Can be opened by: fingerprint only, fingerprint & PIN code, PIN code only

Mfg # SG6120 411 EZ # 085436 (satin chrome) Mfg # SG6123 309 EZ # 085437 (bright brass)



6700 Series Locks

- U.L. Group 2 rating
- 2 year warranty.
- "Regular" key change
- Includes a torque adjustment feature
- 3-wheel offering up to 1 million combinations
- Includes a 4-way drive cam for mounting on right hand or left hand, vertical-up or vertical-down positions
- The relocking trigger automatically deadlocks the bolt if entry is attempted by punching the spindle or lock case.

Mfg. #	Description	EZ #	Mfg. #	Description	EZ #
<i>Lock with D300 Dial, R211 Ring</i>			<i>Parts</i>		
SGR6730D300R211	No tube, relock	027438	SG6720 043 001	Change key	029231
<i>G2 Economy Lock with D300 Dial, R211 Ring</i>			SG6720 053 004	Spline key	037023
SG6741 106	No tube, relock	030498			
<i>Lock Only</i>					
SGR6730	No tube, relock	027437			



8077AD Combination Padlock

3-wheel, open shackle padlock designed to resist most modern methods of entry. Recommended for indoor use only, the 8077 offers protection against manipulation, radiographic and surreptitious attack.

Body made of die-cast Zamak with an outer shell of specially hardened and coated steel. Chrome finish makes it virtually impossible to mask any attempt to determine the combination by drilling the lock case.

125,000 possible combinations which are easily changeable by change key. Meets Federal Specification FF-P-110-G

Dimensions: 2 3/8" (60mm) wide x 4 1/2" (106mm) H x 1 3/8" (50mm) D Shackle Opening: 7/8" (22mm)

Mfg # SG8077AD EZ # 027443



8400 / 8500 Series Security Locks

Manipulation-Proof Locks designed to provide positive resistance against entry by manipulation through sense of touch, sound, "reading," and electronic listening. In addition, this series has passed rigid examination by Underwriters Laboratories, which lists them as Group 1 and Group 1R.

- Key changeable
- Brass wheels – up to 1 million combinations possible
- Special Relocking trigger
- Can be installed for mounting on right hand or left hand, vertical-up or vertical-down positions
- Includes a torque adjustment feature
- Meets Military Specification MIL-L-15596 E

Mfg # SG8410MP D041R162 EZ # 027444 (8410 uses a centi-spline dial)

Mfg # SG8415 100 EZ # 013193 Mfg # SG8415 105 EZ # 075964 Mfg # SG8550MP D054 EZ # 028749



8410MP x DO41 x R162

Safe Lock Dials and Rings

Spyproof – Spyproof dials & rings provide added security by permitting only the person dialing the combination to see the numbers involved.

Convertible – Convertible dials have a larger knob diameter and unique grip. The non-keylocking dials can be used with existing dial rings but the keylocking dials must be used with the proper type dial ring.

Centispline – Centispline dials enable a dial to be adjusted so that the lock can be used in any of 360 degree positions while maintaining an opening reference of 0.

6700 Series Group 2				8400 Series Group 1			
Front Reading Dial Ring Spindle	Spy Proof Dial Ring Spindle
Standard D003 R004 5/16-40	Centi-spline R162 3/8-30
Standard, Convertible D300 R211 5/16-40				
Std, Convert., Key Lock D690 R211 5/16-40				
Spy-Proof Dial Ring Spindle				
Standard D022 R162 5/16-40				
Convertible D220 R167 5/16-40				
Convert. Key Locking D225 R167 5/16-40				

Dial, Ring & Spindle Selection Chart

Safe Lock Dials

Mfg #	EZ #	Description
SGD003 003	027424	Standard Front Reading
SGD300	027718	Standard Convertible
SGD690 009	013187	Std. Convertible Key Locking
SGD220	028156	Spy-Proof, convertible
SGD225 016	068282	Spy-Proof, Key-Locking , Chrome Finish
SGD225	027440	Spy-Proof, Key-Locking, convertible
SGD017 007	036985	Front Reading



Safe Lock Rings

Mfg #	EZ #	Description
SGR211 002	013182	For Front Reading Dial
SGR004 002	013183	For Front Reading Dial
SGR034 002	036988	For Front Reading Dial
SGR162	027427	For Standard Spy-Proof Dial
SGR167	027726	For Spy-Proof Dial
SGR167 014	068281	For Spy-Proof Dial Chrome



Spindle Extension Kit – 5/16

When a standard spindle isn't long enough, a spindle extension may be the answer. Each kit includes spindle extension, collar and two special spline keys to connect extension to dial spindle.

Mfg# SG7312 001 EZ # 037030

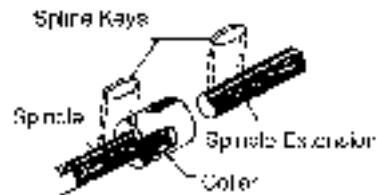



Sliding Deadbolts

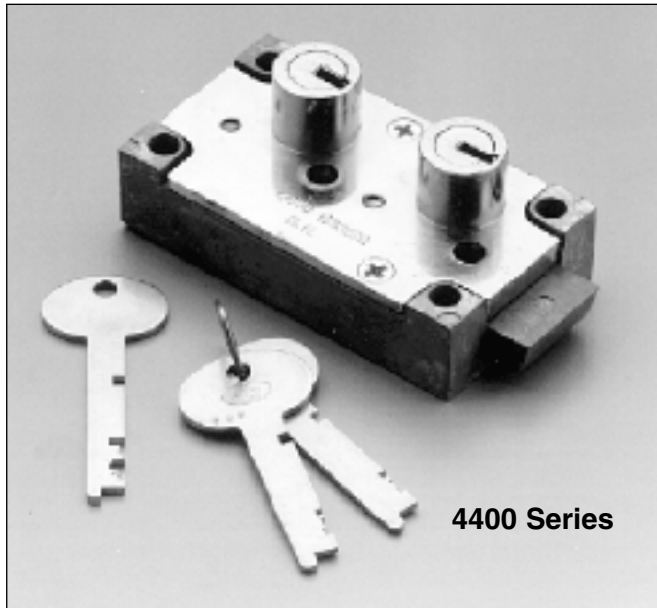

Fixed Horn, Fixed Lever
Lock Dimension: 3 3/8" W x 1.781" H x 1.25" D.

Model #	4440	4442	4443
Renter Horn Dia.	.672"	.84"	.84"
Guard Horn Dia.	.672"	.672"	.84"
Prep Key Blank	87H	87H	58
Renter Key Blank	96	60	60

Mfg. #	Hand	Prep	EZ #
SG4440 018	LH	4	013202
SG4440 070	RH	4	037012
SG4442LH	LH	4	027435
SG4442RH	RH	4	027436
SG4443 008 LH	LH	4	041958
SG4443 028 RH	RH	4	041959

KEY BLANKS BX-50

Mfg. #	Description	EZ #
SG60	Rent/4442-4443	013205
SG87H	Std. Guard/44-4500	013209
SG9500 003	Rent/44-4500 (96)	013217
SG96G	Grv F/0820	013218

Prep Keys and Replacement Parts

Mfg. #	Description	EZ #
SG4Prep KEY	Prep Key	013200
SG4440 002 006	4440 Cover, RH	027431
SG4440 002 007	4440 Cover, LH	027432
SG4442 002 003	4442 Cover, RH	041956
SG4442 002 004	4442 Cover, LH	041957
SG4443 002 003	4443 Cover, RH	041962
SG4443 002 004	4443 Cover, LH	041963

Mfg. #	Description	EZ #
SG8077 043	Change Key F/8077AD	041968
SG4443 004 082 OBR	Lg. Front Plug Flat	041966
SG4440 004 077	Plug Guard Flat	041955
SG4440 004 080	4440 Renter Plug	027433
SG4440 016 002	4440/2 Renters Cam	027434

Surface Mount Sliding Deadbolts

- Surface mount design for ease of installation and suitability to a wide range of applications
- Full 1" (25.4mm) bolt throw
- Hardened steel pins inside the bolt resist sawing and over one ton of thrust
- Both models can be secured in the locked or unlocked position
- The 1881 will accept any 3/8" (8mm) diameter shackle padlock, such as the S&G 8077AD
- The 1883 incorporates a 4-pin tumbler cylinder operated by key cut on National D4291 blank

Dimensions: 5 1/4" long x 1 1/2" wide x 1 3/8" high.

Mfg #	Strike	EZ #
SG1881 002	#12	013190
SG1881 003	#13	075963
SG1881 004	#14	064681
SG1883 002	#12	041954

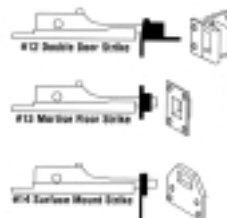

1881
Padlocking Model



1883
Keylocking Model



8470 Series Deadbolt Package

The deadbolt section of the 8470 offers several points of resistance against physical attack. Its design includes hardened steel pins and an interlocking strike and frame to prevent jacking or spreading of the door frame. It is also equipped with an inside release knob for convenient exiting and an automatic deadbolt trigger that locks for extra security. This trigger enables the 8470 to be set in the locked position while the door is open. Positive locking is then insured when the door is closed.

The 8470 combination lock is designed for use with Sargent & Greenleaf's MP Series combination locks (8400 & 8500 models). These locks are manipulation-proof to protect against surreptitious attack and offer a choice of up to one million different combinations which can be easily changed. A relocking trigger, which automatically deadlocks the unit if the spindle is punched, is also a standard feature. The inner workings are made of brass, but Delrin wheels are available for protection against x-ray attack. As an additional precaution, spy-proof dials and rings are standard.

Its U.L. Group 1 and 1R security rating testifies to its reliability and performance.

A standard feature of the 8470 is the new LOCK-OPEN latch. This feature provides a convenient alternative to door traffic delays. With the sliding latch added to the back cover of the Group 1 Combination lock, the dial can be "locked" in the unlocked position. This provides the benefit of easy traffic flow without annoying delays.

Meets Military Specification MIL-L-15596-E. NSN 5340-00-671-6607. Meets or exceeds the requirements of Industrial Security Manual for Entrance Door.

Mfg # 8415-SMR-SPY-XH1 EZ # 027445

Contains: 8470 x T8415MP x D41 x DR162 w/#1 strike w/hard plate

(Shown with optional Life Safety Feature)

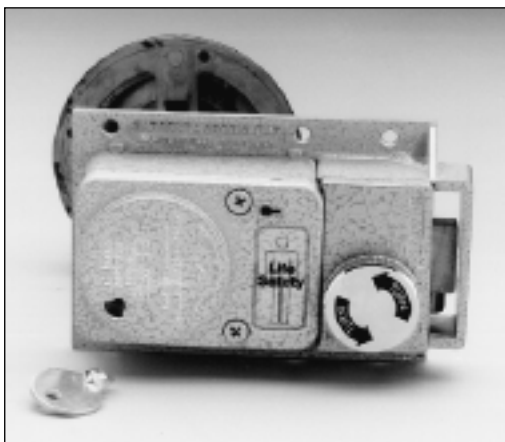

8497 Brute

This surface-mounted, electro-mechanical lock operates on a 24 volt DC current. Features an inside release knob which allows manual operation from the inside. Equipped with an automatic deadlocking device to insure positive locking for increased security.

Includes a built-in key bypass feature that gives the option of outside manual operation by installing



a standard rim cylinder. Standard unit comes with inswing bolt, outswing bolt is special order.

The 8497 Brute has unusual strength due to its unique interlocking strike and lock body construction. This enables the Brute to resist physical attack by jacking or spreading door frames to disengage the bolt from the strike. The bolt contains hardened steel pins to resist sawing. Uses the same strikes as the 8470 to accommodate most types of installations and security needs.

Specifications:

Material: Die cast Zamak finished in gray hammertone with chrome knob.

Power: Requires 10 amp initial surge w/300 ma holding current.

NSN: 6350-00-610-1962

Mfg # SG8497 102 EZ # 037032

Strikes

Mfg #	Description	EZ #
SG8497 001	No. 1 Strike	041951
SG2	No. 2 Strike	027422
SG3	No. 3 Strike	027423
SG8497 004	No. 9 Strike	041952



No. 1 Strike
Single/Double Door Regular Bevel
For Inswinging Door



No. 2 Strike
Single Door Reverse Bevel
For Outswinging Door



No. 3 Strike
Single/Double Door Regular Bevel
For Inswinging Door



No. 9 Strike
Double Door Reverse Bevel
For Outswinging Door



6 Line Standard Duty Locksets

- Standard 2 3/8" or 2 3/4" backset fits Federal Specification Series 160 & ANSI A115.3 cutouts
- Conforms to Federal Spec. FF-H-106, Series 160 & ANSI A156.2, Series 4000 Grade 2

Mfg. #	B.S.	Kwy.	EZ #	Mfg. #	B.S.	EZ #
Entrance				Privacy		
SA24 6G05OB10B LA	2 3/4"	LA	027401	SA2428 6U65OB10B	2 3/4"	062150
SA24 6G05OB26D LA	2 3/4"	LA	011961	SA2428 6U65OB26D	2 3/4"	062146
SA6G05OB10B LA	2 3/8"	LA	041945	Passage		
SA6G05OB26D LA	2 3/8"	LA	043134	SA2428 6U15OB10B	2 3/4"	062149
SA6G05OB26 LC	2 3/8"	-	080939	Classroom		
Storeroom				SA6G37OB10B	2 3/8"	069510
SA6G04OB10B LA	2 3/8"	LA	062148	SA6G37OB26D	2 3/8"	069509
SA6G04OB26D LA	2 3/8"	LA	041926	<i>LC = Less Cylinder 28 = ANSI Strike 24 = 2 3/4" B.S.</i>		



OB Knob Design

Replacement Deadlatches

Mfg #	BS	EZ #
SA06 5083 10B	2 3/8"	041948
SA06 5083 26D	2 3/8"	012124
SA06 5094 10B	2 3/4"	041949
SA06 5094 26D	2 3/4"	012126

8 Line Heavy Duty Locksets

- 2 3/4" backset • U. L. Listed for use on fire doors • ANSI A156.2, Series 4000 Grade 1 • Universal, Non handed

Mfg. #	EZ #	Mfg. #	EZ #	Mfg. #	EZ #
Entrance		Storeroom		Passage	
SA8G05OB10B LC	077440	SA8G04OB626 LC	077437	SA8U15OB10B	077442
SA8G05OB626 LC	077436	SA8G05OB 26D LA	029160	SA8U15OB626	077438
SA8G04OB 26D LA	011984	Privacy			
Storeroom		SA8U65OB10B	077443		
SA8G04OB10B LC	077441	SA8U65OB626	077439		



LC = Less Cylinder

10 - Line Grade 1 Levers

- Heavy duty key-in-lever lockset designed to exceed the requirements of ANSI A156.2, Series 4000
- Reversible, supplied right hand standard • 2 3/4" BS with curved lip strike • U. L. listed for use on fire doors

Mfg. #	Function	EZ #	Mfg. #	Function	EZ #
SA10U15 LB 26D	Passage	071298	SA10G05 LL 26D	Entry/Office	069496
SA10U15 LL 26	Passage	069504	SA10G37 LL 10B	Classroom	069500
SA10U15 LL 10B	Passage	069503	SA10G37 LL 26	Classroom	069501
SA10U15 LL 26D	Passage	069502	SA10G37 LL 26D	Classroom	069499
SA10U65 LB 26D	Privacy	071296	SA10G04 LB 26D	Storeroom	071297
SA10U65 LL 10B	Privacy	069506	SA10G04 LL 10B	Storeroom	069494
SA10U65 LL 26	Privacy	069507	SA10G04 LL 26	Storeroom	069495
SA10U65 LL 26D	Privacy	069505	SA10G04 LL 26D	Storeroom	069493
SA10G05 LL 10B	Entry/Office	069497	SA10G04 LL 26D LC	Storeroom	080339
SA10G05 LL 26	Entry/Office	069498	<i>LC = Less Cylinder</i>		



LL Design

2 3/4" Deadlatches For 10 Line

Mfg. # SA10 2000 10B	EZ # 069569
Mfg. # SA10 2000 26D	EZ # 069544

6, 10, 11 & 65 Line Key-N-Knob Cylinder Plugs

Mfg #	Kwy	EZ #	Mfg #	Kwy	EZ #	Mfg #	Kwy	EZ #	Mfg #	Kwy	EZ #
Satin Brass Plated Finish			Satin Brass Plated Finish			Satin Nickel Finish			Satin Nickel Finish		
SA13 3142 4LB	LB	069527	SA13 3142 4RE	RE	069538	SA13 3142 15HE	HE	082858	SA13 3142 15LL	LL	029125
SA13 3142 4LC	LC	069528	SA13 3142 4RF	RF	069539	SA13 3142 15HF	HF	082859	SA13 3142 15RA	RA	012048
SA13 3142 4LE	LE	069529	SA13 3142 4RG	RG	069540	SA13 3142 15HG	HG	082860	SA13 3142 15RB	RB	012049
SA13 3142 4LF	LF	069530	SA13 3142 4RJ	RJ	069541	SA13 3142 15LA	LA	012040	SA13 3142 15RC	RC	012050
SA13 3142 4LG	LG	069531	SA13 3142 4RK	RK	069542	SA13 3142 15LB	LB	012041	SA13 3142 15RE	RE	012051
SA13 3142 4LJ	LJ	069532	SA13 3142 4RL	RL	069543	SA13 3142 15LC	LC	012042	SA13 3142 15RF	RF	012052
SA13 3142 4LK	LK	069533	Satin Nickel Finish			SA13 3142 15LE	LE	012043	SA13 3142 15RG	RG	012053
SA13 3142 4LL	LL	069534	SA13 3142 15CA	CA	064107	SA13 3142 15LF	LF	012044	SA13 3142 15RJ	RJ	012054
SA13 3142 4RA	RA	069535	SA13 3142 15HA	HA	082855	SA13 3142 15LG	LG	012045	SA13 3142 15RK	RK	012055
SA13 3142 4RB	RB	069536	SA13 3142 15HB	HB	082856	SA13 3142 15LJ	LJ	012046	SA13 3142 15RL	RL	012056
SA13 3142 4RC	RC	069537	SA13 3142 15HC	HC	082857	SA13 3142 15LK	LK	012047	SA13 3142 15S	S	012057

6500 - Line Grade 2 Lever Locks

- Standard duty key-in-lever lockset designed to exceed the requirements of ANSI A156.2, Series 4000
- Universal, not handed • 2 3/4" BS with curved lip strike • U. L. listed for use on fire doors

Mfg. #	Function	EZ #
SA65U15KL26D	Passage	064116
SA65U65KL26D	Privacy	064117
SA65G05KL26D	Entry/Office	064115
SA65G04KL26	Storeroom	084249
SA65G04KL26D	Storeroom	064114
SA65G37KL26D	Classroom	069508

Deadlatches For 6500 Line

Mfg. #	Size	EZ #
SA05 2182 26D	2 3/4"	069545
SA05 2184 26D	2 3/8"	069515



KL Design

T-Zone Lockset

- Unequalled strength and durability from unique construction • Standard 2 3/4" backset • Eliminates lever sag even after 2 mil. cycles
- 2400 lbs. of torque resistance - 2.5 time ANSI Grade 1 requirements • Only 45° lever rotation required to retract latch

Mfg. #	Function	EZ #	Mfg. #	Function	EZ #
SA11G04LL26D	Storeroom	075530	SA28 11G05LL26D	Entry	074870
SA11G05LL26D	Entry	075531	SA28 11G17LL 26D	Institutional	082853
SA11G37LL26D	Classroom	075532	SA28 11G30LL 26D	Communicating	082854
SA28 70 11G04LL26D	Storeroom IC	076647	SA28 11U15LL26D	Passage	074872
SA28 70 11G05LL26D	Entry IC	076648	SA28 11G37LL26D	Classroom	074871
SA28 70 11G37LL26D	Classroom IC	076649	SA28 11U65LL26D	Privacy	074873
SA28 11G04LL26D	Storeroom	074869	SA28 30 11G04LL26D	Storeroom KIK	075387
28 = ANSI Strike	30 = Accepts Schlage cylinder		SA28 30 11G05LL26D	Entry KIK	075386
			SA28 30 11G37LL26D	Classroom KIK	075388



LL Design

Accessories

Mfg. #	Desc.	EZ #
SA800 32D	T Strike	082870
SA28 808 32D	ASA Strike	082871
SA01 1472	Allen type set screw	082864
SA11 2009 26D	Locking sleeve assy - 04, 05, 16, 24, 44 functions, outside	082861
SA11 2011	Locking sleeve assy - 16, 38 functions, inside	082865
SA11 2153	Non-Locking sleeve assy - 15, 15-3, 37 functions, inside - 15 function, outside	082866
SA11 2151 26D	Non-Locking sleeve assy - 04, 13, 50 functions, inside	082862
SA11 2152 26D	Non-Locking sleeve assy - 05, 24, functions, inside	082863

470 Series Deadbolts

- 2 3/8" or 2 3/4" adj. backset • Grade 2 ANSI 156.5 1000 series

Mfg. #	Function	EZ #
SA474 26D LA	Dbl Cyl	073419
SA474 10B LA	Dbl Cyl	073420
SA475 26D LA	Sgl Cyl	073421
SA475 10B LA	Sgl Cyl	073422



Inside turn lever

758 Padlock

- 1" shackle standard • Brass finish
- Stainless steel shackle • Key capture standard
- Key removable in locked position only
- Cylinder 10 line standard - 2 keys per padlock

Mfg # SA758 EZ # 077444



8800 Series Exit Device

- For wood or metal doors 1 3/4" thick standard • Meets ANSI standard 156.3, Grade 1 • 641 Standard Strike
- High impact resistant Lexan touchpad on rail assembly • UL Listed • 5 year warranty

Mfg. #	Desc / Function	EZ #
SA8804PTB 32D	Exit with night latch	076084
SA8810EO 32D	Exit only panic	074508
SA8810PTB 32D	Exit with dummy trim	076083
SA8888F 32D	Reversible exit device	065089
SA812PTB DT 26D	Dummy trim	074509
SA812PTB 26D	Key retracts latchbolt	074510



PTB Trim



1 1/8" Mortise Cylinder Plugs

Mfg #	Fin	Kwy	EZ #	Mfg #	Fin	Kwy	EZ #	Mfg #	Fin	Kwy	EZ #
SA13 0401 4LB	4	LB	069517	SA13 0401 4RG	4	RG	069579	SA13 0401 15RB	15	RB	012091
SA13 0401 4LC	4	LC	069518	SA13 0401 4RJ	4	RJ	069580	SA13 0401 15RC	15	RC	012092
SA13 0401 4LE	4	LE	069519	SA13 0401 4RK	4	RK	069581	SA13 0401 15RE	15	RE	012093
SA13 0401 4LF	4	LF	069520	SA13 0401 4RL	4	RL	069582	SA13 0401 15RF	15	RF	012094
SA13 0401 4LG	4	LG	069521	SA13 0401 15CA	15	CA	064109	SA13 0401 15RG	15	RG	012095
SA13 0401 4LJ	4	LJ	069522	SA13 0401 15LB	15	LB	012081	SA13 0401 15RJ	15	RJ	012096
SA13 0401 4LK	4	LK	069523	SA13 0401 15LC	15	LC	012082	SA13 0401 15RK	15	RK	012097
SA13 0401 4LL	4	LL	069524	SA13 0401 15LE	15	LE	012083	SA13 0401 15RL	15	RL	029148
SA13 0401 4RA	4	RA	069525	SA13 0401 15LF	15	LF	012084	<i>4 - Satin Brass 15 - Satin Nickel Plated</i>			
SA13 0401 4RB	4	RB	069575	SA13 0401 15LG	15	LG	012085	Misc. Parts			
SA13 0401 4RC	4	RC	069576	SA13 0401 15LJ	15	LJ	012086	<u>Mfg #</u>	<u>Desc.</u>	<u>EZ #</u>	
SA13 0401 4RE	4	RE	069577	SA13 0401 15LK	15	LK	012087	SA13 0512	Adams Rite Cam	069514	
SA13 0401 4RF	4	RF	069578	SA13 0401 15LL	15	LL	000469	SA6042 26D	I/C Mort Cylinder Housing	030072	
				SA13 0401 15RA	15	RA	012090				

Mortise / Rim Cylinders

Mfg #	Kwy	Fin	EZ #
SA41 3 LA	LA	3	069513
SA41 10B LA	LA	10B	069512
SA41 26 LA	LA	26	074989
SA41 26D LA	LA	26D	012077
SA41 26D S	S	26D	012079
SA34 10B LA	LA	10B	069511
SA34 26D LA	LA	26D	012061

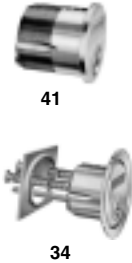

34 Series Plugs

Mfg #	Fin	Kwy	EZ #
SA13 0090 15LB	15	LB	029150
SA13 0090 15LC	15	LC	029151
SA13 0090 15LE	15	LE	029152
SA13 0090 15LF	15	LF	029153
SA13 0090 15LG	15	LG	012066
SA13 0090 15LJ	15	LJ	069526
SA13 0090 15LK	15	LK	029154
SA13 0090 15LL	15	LL	012067
SA13 0090 15RA	15	RA	012068
SA13 0090 15RB	15	RB	012069
SA13 0090 15RC	15	RC	029155
SA13 0090 15RE	15	RE	012070
SA13 0090 15RF	15	RF	012071
SA13 0090 15RG	15	RG	012072
SA13 0090 15RJ	15	RJ	029156
SA13 0090 15RK	15	RK	029157
SA13 0090 15RL	15	RL	012073

15 - Satin Nickel Plated

Uncombined Removable Core
 Mfg # SA65 6300HA15
 Keyway: HA
 EZ # 069516
 Mfg # SA65 6300LA15
 Keyway: LA
 EZ # 069546



KIK Cylinder

Mfg #	Desc	EZ #
SA13 3127 15LA	Cyl. assy. f/6 line	069548
SA13 3266 15LA	Cyl. assy. f/65,7,10,11 line	069547

Spindle

Mfg #	Desc	EZ #
SA578 2	Outside threaded spindle	064967
SA579 2	Split spindle non-threaded	064968

Original Key Blanks

Mfg. #	Pins	EZ #	Mfg. #	Pins	EZ #	Mfg. #	Pins	EZ #	Mfg. #	Pins	EZ #
SA265U	5	011841	SA275RC	5	011874	SA6270LDH	6	011907	SA6275HB	6	028783
SA270LN	5	011848	SA275RE	5	011875	SA6270LDM	6	076948	SA6275HC	6	028784
SA270RN	5	011855	SA275RG	5	011877	SA6270LH	6	011909	SA6275HF	6	027417
SA273CN	5	041950	SA275RJ	5	011878	SA6270LHM	6	076947	SA6275HJ	6	028786
SANS275LA	5	027413	SA275S	5	011881	SA6270LM	6	011911	SA6275HK	6	028787
SA275LB	5	027414	SA6265U	6	011905	SA6270LN	6	011912	SA6275HL	6	028788
SA275LC	5	027415	SA6270HH	6	076942	SA6270RD	6	011913	SANS6275LA	6	027418
SA275LE	5	011866	SA6270HHM	6	076945	SA6270RDH	6	076938	SANS6275LB	6	027419
SA275LF	5	011867	SA6270HD	6	028789	SA6270RDM	6	076940	SANS6275LC	6	027420
SA275LG	5	011868	SA6270HDH	6	076943	SA6270RH	6	011916	SA6275LE	6	011928
SA275LJ	5	011869	SA6270HDM	6	076946	SA6270RHM	6	076939	SA6275LF	6	011929
SA275LK	5	011870	SA6270HG	6	076941	SA6270RM	6	011918	SA6275LG	6	011930
SA275LL	5	011871	SA6270HM	6	076944	SA6270RN	6	011919	SA6275LJ	6	011931
SA275RA	5	011872	SA6270HN	6	028812	SA6273CN	6	011924	SA6275LK	6	011932
SA275RB	5	011873	SA6270LD	6	011906	SA6275HA	6	028782	SA6275LL	6	011933

Keypad Mortise Locks

- 3/4" stainless steel, antifriction reversible latchbolt • Operates with 4 "C" batteries (included)
- Low battery indicator • 100 user codes - over 1,100,000 possible user combinations

Mfg. #	Desc.	EZ #
SAKP8276LJ 26D	Entry Mort Lock w/cyl override	074247
SAKP8276LL26D	Entry Mort Lock w/cyl override	075519
SAKP8276LNL26D	Entry Mort Lock w/cyl override	082868
SAKP8278LNL26D	Entry Mort Lock w/cyl less deadbolt	082869
SAKP10G77LJ 26D	10-Line Keypad Lock	074248
SAKP10G77LL26DLA	10-Line Keypad Lock	075518
SAKP70-10G77LL26D	10-Line Keypad Lock - I/C	074316



Mortise Deadbolt

- Furnished standard for 1 3/8" thick doors • 2 3/8" backset
- Brass bolt 1" throw with hardened steel rollers standard
- Heavy wrought steel case • Non-handed • UL/cUL listed for use on fire doors
- 4874: Deadbolt operated from either side by key. Use on rooms with more than one exit.

Mfg # SA4874LC 26D EZ # 085247



281 Door Closer

- ANSI/BHMA Grade 1 • Versatile mounting application
- UL and cUL listed for use on fire doors • Meets ADA requirements
- Adjustable spring power allows a size range of 1 through 6

Mfg # SA281UO EN EZ # 072842 UO = Universal Arm, EN = Aluminum Enamel finish

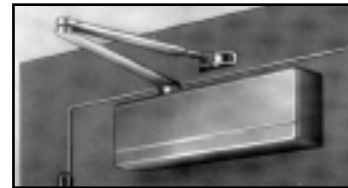
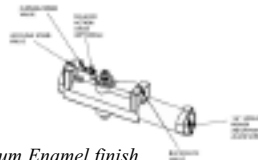

1431 Door Closer

- Adjustable spring power, from size 1 through 4 • Non corrosive high impact cover, flame retardant.
- Full rack and pinion provides control from the full open position • Meets ADA requirements

Mfg # SA1431 UO EZ # 073344 Mfg # SA1431UO EB EZ # 080303 UO = Universal Arm EB= Reversible

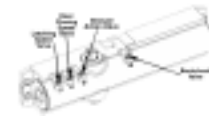



Key Blanks • Parts

8200 Series Mortise Locksets

- Lock body conforms to Federal Spec. FF-H-106 Type 86; and ANSI A156.13, Series 1000
- For Doors 1 3/4" thick standard, 2 3/4" backset • Armored Front: 8" x 11/4", ANSI Standard A115.1
- Latch Bolt: Brass 5/8" throw; with nylon anti-friction insert • Handed: May be reversed
- Dead Bolt: Brass. 1" throw with hardened steel rollers • Case: Wrought steel, zinc dichromate finish

8204 Storeroom Function

- Guard bolt deadlocks latchbolt • Outside lever rigid at all times
- Latchbolt retracted by lever inside or key outside

Mfg # SALC8204 LNB 10B RH	EZ # 074943	
Mfg # SALC8204 LNB 26 RH	EZ # 074990	
Mfg # SALC8204 LNB 26D RH	EZ # 074918	
Mfg # SALC8204 LNJ 26D RH	EZ # 074919	
Mfg # SALC8204 LNL 26D RH	EZ # 070709	
Mfg # SALC8204 LNP 26D RH	EZ # 074533	
Mfg # SALC8204 LW1L 26D	EZ # 077384	
Mfg # SATR8204LW 1L26D RH	EZ # 074500	(trim pack)
Mfg # SA8204 26D	EZ # 082839	(body only)

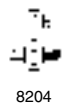

8204

8205 Office Function

- Guard bolt deadlocks latch bolt
- Latch bolt retracted by either lever unless outside lever is locked by toggle in lock front
- Key outside retracts latch bolt when outside lever is locked

Mfg # SALC8205 LNB 10B RH	EZ # 074920	
Mfg # SALC8205 LNB 26 RH	EZ # 074921	
Mfg # SALC8205 LNB 26D RH	EZ # 074942	
Mfg # SALC8205 LNJ 26D RH	EZ # 074944	
Mfg # SALC8205 LW1L 26D	EZ # 077383	
Mfg # SA8205 26D	EZ # 072649	(body only)

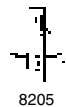

8205

8237 Classroom Lock

- Guard bolt deadlocks latch bolt. • Inside lever always operative
- Latch bolt retracted by either lever unless outside lever is locked by key
- Key outside locks or unlocks outside lever
- Latchbolt can be retracted by key in locked position

Mfg # SALC8237 LNB 10B RH	EZ # 074945	
Mfg # SALC8237 LNB 26 RH	EZ # 074946	
Mfg # SALC8237 LNB 26D RH	EZ # 074947	
Mfg # SALC8237 LNJ 26D RH	EZ # 074941	
Mfg # SALC8237 LNL 26D	EZ # 078125	
Mfg # SALC8237 LW1L 26D	EZ # 077385	
Mfg # SA8237 26D	EZ # 082838	(body only)

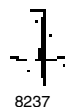

8237

8215 Passage

- Latch bolt retracted by either lever

Mfg # SA8215 LNB 10B RH	EZ # 069487
Mfg # SA8215 LNB 26 RH	EZ # 069488
Mfg # SA8215 LNB 26D RH	EZ # 064105
Mfg # SA8215 LNJ 26D RH	EZ # 069489
Mfg # SA8215 LNL 26D RH	EZ # 063995
Mfg # SA8215 LNP 26D RH	EZ # 074534



8215

8245 Dwelling Entrance Lock

- Latch bolt retracted by either lever, unless outside lever is locked by toggle in lock front.
- Deadbolt operated by key outside, turn lever inside.
- Key outside retracts both latchbolt and deadbolt.
- When deadbolt is projected, outside lever is automatically locked
- Operating inside lever automatically retracts latchbolt and deadbolt with outside lever remaining locked

Mfg # SALC8245 LNB 10B RH	EZ # 074948
Mfg # SALC8245 LNB 26 RH	EZ # 074949
Mfg # SALC8245 LNB 26D RH	EZ # 074950
Mfg # SALC8245 LNJ 26D RH	EZ # 074951
Mfg # SALC8245 LNL 26D RH	EZ # 063994

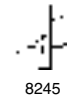

8245

8265 Bathroom Function

- Latch bolt retracted by either lever.
- Turn lever automatically locks outside lever.
- Operating inside lever automatically retracts latch bolt unlocking outside lever.
- Outside emergency release unlocks outside lever.

Mfg # SA8265 LNB 10B RH	EZ # 069490
Mfg # SA8265 LNB 26 RH	EZ # 069491
Mfg # SA8265 LNB 26D RH	EZ # 064106
Mfg # SA8265 LNJ 26D RH	EZ # 069492
Mfg # SA8265 LNL 26D RH	EZ # 063996
Mfg # SA8265 LNP 26D RH	EZ # 074532

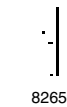

8265

LC = Less Cylinder



LW1L



LNJ



LNL



LNP



LNB



Latches And Extension Links

A Series Cylindrical Locks

- Application: Heavy duty residential, light & medium commercial.
- Certification: ANSI A156.2 Series 4000 Grade 2. U.L. listed.
- Door Range: 1 3/8" to 1 7/8" standard. Backset: 2 3/4" standard
- Latch: 1/2" throw deadlatch; 1/2" throw springlatch.
- All keyed locks sold less cylinder

Mfg. #	EZ #	Mfg. #	EZ #	Mfg. #	EZ #
Exit Locksets		Passage		Classroom Locksets	
SCA25LD PLY 626	039574	SCA10S GEO605	063745	SCA70LD ORB613	071514
Entrance Locksets		SCA10S GEO609	063742	SCA70LD ORB625	071515
SCA53LD GEO605	071511	SCA10S ORB605	027450	SCA70LD ORB626	037309
SCA53LD GEO609	071512	SCA10S ORB613	041971	SCA70LD PLY626	071646
SCA53LD ORB605	027471	SCA10S ORB625	063751	Single Dummy Knob	
SCA53LD ORB612	066019	SCA10S ORB626	027453	SCA170 GEO605	063747
SCA53LD ORB613	065891	SCA10S PLY605	027455	SCA170 GEO609	063744
SCA53LD ORB625	071513	SCA10S PLY626	041972	SCA170 ORB605	063749
SCA53LD ORB626	027475	Privacy		SCA170 ORB625	063755
SCA53LD PLY605	041979	SCA40S GEO605	063746	SCA170 ORB626	063756
SCA53LD PLY626	027478	SCA40S GEO609	063743	SCA170 PLY605	063741
SCA53LD TUL626	027479	SCA40S ORB605	063748	SCA170 PLY626	041987
Storeroom Locksets		SCA40S ORB625	063752		
SCA80LD ORB605	037051	SCA40S ORB613	063757		
SCA80LD ORB612	066020	SCA40S ORB626	041974		
SCA80LD ORB613	068292	SCA40S PLY605	027465		
SCA80LD ORB625	071516	SCA40S PLY626	041973		
SCA80LD ORB626	060654				
SCA80LD PLY605	071517				
SCA80LD PLY626	027491				



Orbit
Symbol: Orb
Knob: 2 1/8" dia.
Rose: 2 9/16" dia.
Projection: 2 7/8"



Georgian
Symbol: Geo
Knob: 2 1/8" dia.
Rose: 2 9/16" dia.
Projection: 2 5/16"



Tulip
Symbol: Tul
Knob: 2" dia.
Rose: 2 9/16" dia.
Projection: 2 3/8"



Plymouth
Symbol: Ply
Knob: 2 1/8" dia.
Rose: 2 9/16" dia.
Projection: 2 3/16"



A53PD Orbit

Mfg. #	B.S.	Faceplate	EZ #	Mfg. #	B.S.	Faceplate	EZ #
A SERIES Springlatches - 1/2" throw				D SERIES Deadlatches - 1/2" throw			
SC11 068 605	2 3/8"	1" x 2 1/4"	012681	SC14 047 605	2 3/8"	1 1/8" x 2 1/4"	012735
SC11 068 626	2 3/8"	1" x 2 1/4"	012683	SC14 047 613	2 3/8"	1 1/8" x 2 1/4"	071496
SC11 111 626	2 3/4"	1" x 2 1/4"	012700	SC14 047 626	2 3/8"	1 1/8" x 2 1/4"	012736
SC11 116 605	2 3/4"	1 1/8" x 2 1/4"	012702	SC14 019 605	2 3/4"	1 1/8" x 2 1/4"	012732
A SERIES Deadlatches - 1/2" throw				SC14 019 613	2 3/4"	1 1/8" x 2 1/4"	071497
SC11 085 605	2 3/8"	1" x 2 1/4"	012684	SC14 019 626	2 3/4"	1 1/8" x 2 1/4"	012734
SC11 085 613	2 3/8"	1" x 2 1/4"	012686	D SERIES 5" Extension Link (must be used with 14-019)			
SC11 085 626	2 3/8"	1" x 2 1/4"	012687	SC43 005	5" link	-	013151
SC11 096 605	2 3/4"	1 1/8" x 2 1/4"	012690	F Series Deadlatches - Adjustable 2 3/8" or 2 3/4", 1/2" throw			
SC11 096 613	2 3/4"	1 1/8" x 2 1/4"	012692	SC16 203 626	Adj	1" x 2 1/4"	012752
SC11 096 626	2 3/4"	1 1/8" x 2 1/4"	012693	SC16 207 605	Adj	1" x 2 1/4"	037118
SC11 104 626	2 3/8"	1" Drive-in	027556	SC16 207 626	Adj	1" x 2 1/4"	027560
SC11 105 605	2 3/4"	1" Drive-in	012696				
A SERIES 5" Extension Link (must be used with 11-085)							
SC41 005	5" link	N/A	013150				

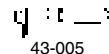
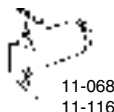



Heavy Duty Cylindrical Locksets

Handlesets

D & ND Series Heavy Duty Cylindrical Locks

- Backset: 2 3/4" standard (2 3/8" available) • Certification: ANSI A156.2 Series 4000 Grade 1. U.L. listed.
- Latch: 1/2" throw • Door Range: 1 3/8" to 2" standard • All keyed locks are sold less cylinder

ND53PD RHODES



Mfg. #	Design	EZ #	Mfg. #	Design	EZ #
Passage Locksets					
SCND10S ATH626	Ath	063578	SCND53LD RHO625	Rho	074016
SCND10S OME626	Ome	081822	SCND53LD RHO626	Rho	012237
SCD10S ORB613	Orb	046478	SCND53BD RHO613	Rho	063711
SCD10S ORB626	Orb	012214	SCND53BD RHO626	Rho	063717
SCD10S PLY626	Ply	037079	SCND53RD RHO626	Rho	069747
SCND10S RHO613	Rho	012218	Store Door Locksets (dbl cyl)		
SCND10S RHO626	Rho	012219	SCND66JD RHO626	Rho	082844
SCD10S SPA625	Spa	082848	Classroom Locksets		
SCD10S SPA626	Spa	081713	SCND70LD OME626	Ome	081820
Exit Locksets					
SCND25DRHO626	Rho	082765	SCD70LD ORB613	Orb	071519
Privacy Locksets					
SCND40S ATH626	Ath	075138	SCD70LD ORB626	Orb	012264
SCND40S OME626	Ome	081821	SCD70JD ORB626	Orb	082842
SCD40S ORB613	Orb	063714	SCD70LD PLY626	Ply	012266
SCD40S ORB626	Orb	027525	SCND70LD RHO612	Rho	061492
SCD40S PLY626	Ply	012224	SCND70LD RHO626	Rho	012269
SCND40S RHO613	Rho	012226	SCND70JD RHO626	Rho	082846
SCND40S RHO626	Rho	012227	Communicating Locksets (dbl cyl)		
SCD40S SPA	Spa	081719	SCD72CD PLY626	Ply	037086
Entrance Locksets					
SCND53LD ATH605	Ath	071853	SCD72JD ORB626	Orb	082843
SCD53LD ATH625	Ath	083949	Corridor Locksets		
SCND53LD ATH626	Ath	063576	SCD73LD PLY626	Ply	071730
SCND53LD OME626	Ome	081818	Storeroom Locksets		
SCD53LD ORB613	Orb	071518	SCND80LD ATH626	Ath	063584
SCD53LD ORB626	Orb	012231	SCND80LD OME626	Ome	081819
SCD53JD ORB626	Orb	082840	SCD80LD ORB613	Orb	071520
SCD53LD PLY626	Ply	012234	SCD80LD ORB626	Orb	012279
SCND53JD RHO 626	Rho	065641	SCD80JD ORB626	Orb	082841
SCND53LD RHO605	Rho	012235	SCD80LD PLY626	Ply	012281
SCND53LD RHO612	Rho	061491	SCND80LD RHO612	Rho	061483
SCND53LD RHO613	Rho	012236	SCND80LD RHO613	Rho	012283
			SCND80LD RHO626	Rho	012284
			SCND80BD RHO626	Rho	063718
			SCND80LDEL RHO626	Rho	074012

Mfg. #	Design	EZ #
Storeroom Locksets		
SCND80LDEU RHO626	Rho	074013
SCND80JD RHO626	Rho	065642
Institution Locksets Double Cylinder		
SCD82CD ORB626	Orb	071521
SCD82RD ORB626	Orb	083950
SCD82CD PLY626	Ply	012295
SCND82JD RHO626	Rho	082845
SCD82LD RHO626	Rho	076131
Storeroom IC Vandgard		
SCND96JD RHO626	Rho	075974

- LD** - Less Cylinder **JD** - Less Full Size I/C
- BD** - Less I/C Core (Best Type) **RD** - Full Size I/C
- CD** - Less (2) Cylinders
- EL** - Electrically Locked (Fail Safe)
- EU** - Electrically Unlocked (Fail Secure)

Plymouth
Symbol: Ply
Knob: 2 1/4" dia.
Rose: 2 9/16" dia.
Projection: 2 9/16"

Orbit
Symbol: Orb
Knob: 2 1/8" dia.
Rose: 2 9/16" dia.
Projection: 2 5/8"

Omega
Symbol: Ome
Lever: 5 5/8" L
Rose: 3 7/16"
Projection: 3 5/16"

Sparta
Symbol: Spa
Lever: 4 16/16" L
Rose: 3 7/16"
Projection: 3 1/2"

Athens
Symbol: Ath
Lever: 4 9/16" L
Rose: 3 7/16"
Projection: 2 13/16"

Rhodes
Symbol: Rho
Lever: 4 7/8" L
Rose: 3 7/16"
Projection: 2 1/2"

F Series Standard Duty Handlesets

Mfg. #	Fin.	Function	EZ #
Bowman			
SCF360 BOW PLY605	605	Single Cylinder	063773
SCF362 BOW PLY605	605	Double Cylinder	063737
Plymouth			
SCF360 PLY ORB605	605	Single Cylinder	063772
SCF360 PLY PLY605	605	Single Cylinder	042006
SCF360 PLY605FLA RH	605	Single Cylinder	071142
SCF362 PLY ORB605	605	Double Cylinder	063736
SCF362 PLY PLY605	605	Double Cylinder	042007
SCF193 PLY PLY605	605	Dummy	063738
Inside Trim			
SCF359 FLA605LH	605	LH Inside Trim	069294
SCF359 FLA605RH	605	RH Inside Trim	069295

Outside Trim Designs



Plymouth Bowman

- Door Range: 1 5/8" to 1 3/4"
- Backset: 2 3/8" - 2 3/4" adjustable
- Forged brass • 1" throw deadbolt



Flair

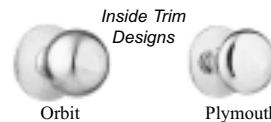















Inside Trim Designs

Orbit Plymouth



F Series Standard Duty Residential Locks

- ANSI A156.2 Series 4000 Grade 3 • Door Range: 1 3/8" to 1 3/4" standard. • Keying: 5 pin tumbler cylinder, "C" keyway
- Backset: Universal latches standard • Entrance/storeroom locks packed 20 per case, others packed 30 except Orb & Fla passage and privacy are packed 20

Mfg. #	Design	Fin.	EZ #	Mfg. #	Design	Fin.	EZ #	Bell
Passage Sets				Entrance Locksets				
SCF10 GEO605	Geo	605	012318	SCF51 BEL 605KA4	Bell	605	066381	
SCF10 GEO609	Geo	609	012319	SCF51N FLA605RH	FLA	605	085561	
SCF10 ORB605	Orb	605	012308	SCF51N FLA605LH	FLA	605	085562	
SCF10 ORB609	Orb	609	012309	SCF51 GEO605 KA4	Geo	605	012358	
SCF10 ORB625	Orb	625	063770	SCF51 GEO609 KA4	Geo	609	012373	
SCF10 ORB626	Orb	626	027539	SCF51 ORB605 KA4	Orb	605	012360	
SCF10 PLY605	Ply	605	012320	SCF51 ORB609 KA4	Orb	609	012386	
SCF10 PLY626	Ply	626	012310	SCF51 ORB625KA4	Orb	625	063768	
SCF10 ELA626	Ela	626	012306	SCF51 ORB626	Orb	626	043156	
SCF10 FLA605LH	Fla	605	012312	SCF51 ORB626 KA4	Orb	626	012361	
SCF10 FLA605RH	Fla	605	012311	SCF51 PLY605 KA4	Ply	605	012371	
SCF10 FLA609LH	Fla	609	012314	SCF51 PLY626 KA4	Ply	626	012384	
SCF10 FLA609RH	Fla	609	012313	SCF51 ORB FLA LH605	Orb x Fla	605	027543	
Privacy Sets				SCF51 ORB FLA RH605	Orb x Fla	605	027544	
SCF40 GEO605	Geo	605	012355	Single Dummy Trim				
SCF40 GEO609	Geo	609	012356	SCF170 GEO605	Geo	605	063767	
SCF40 ORB605	Orb	605	012348	SCF170 GEO609	Geo	609	027551	
SCF40 ORB609	Orb	609	012349	SCF170 ORB605	Orb	605	027548	
SCF40 ORB625	Orb	625	063771	SCF170 ORB609	Orb	609	042005	
SCF40 ORB626	Orb	626	027542	SCF170 ORB625	Orb	625	063769	
SCF40 PLY605	Ply	605	012341	SCF170 ORB626	Orb	626	027549	
SCF40 PLY626	Ply	626	012350	SCF170 PLY605	Ply	605	027550	
SCF40 ELA626	Ela	626	012346	SCF170 PLY626	Ply	626	063766	
SCF40 FLA605LH	Fla	605	012352	SCF170 FLA605LH	Fla	605	012337	
SCF40 FLA605RH	Fla	605	012351	SCF170 FLA605RH	Fla	605	012336	
SCF40 FLA609LH	Fla	609	012354	SCF170 FLA609LH	Fla	609	012339	
SCF40 FLA609RH	Fla	609	012353	SCF170 FLA609RH	Fla	609	012338	

AL Series Standard Duty Locksets

Application: Standard duty commercial exterior & interior.
 Exposed Trim: Wrought brass, bronze. Levers are pressure cast zinc, plated to match finish symbols.
 Backset: 2 3/4" standard (2 3/8" available)
 Certific.: ANSI A156.2 Series 4000 Grade 2. U.L. listed.
 Door Range: 1 3/8" to 1 7/8" standard
 Latch: 1/2" throw

LD - Less Cylinder
 *JD - Less Full Size I/C

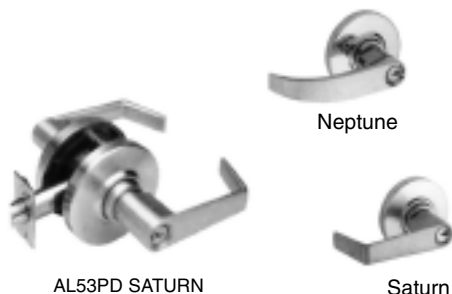

Mfg. #	Lever	EZ #	Mfg. #	Lever	EZ #
Passage			Entrance Locksets		
SCAL10S NEP626	Nep	063676	SCAL53LD SAT613	Sat	071498
SCAL10S SAT605	Sat	063596	SCAL53LD SAT625	Sat	067574
SCAL10S SAT612	Sat	066023	SCAL53LD SAT626	Sat	065923
SCAL10S SAT613	Sat	063775	* SCAL53JD SAT626	Sat	067029
SCAL10S SAT625	Sat	063781	Classroom Locksets		
SCAL10S SAT626	Sat	031140	SCAL70LD SAT613	Sat	071503
Exit With Plate			SCAL70LD SAT625	Sat	071504
SCAL25D SAT626	Sat	031142	SCAL70LD SAT626	Sat	071505
Privacy			Storeroom Locksets		
SCAL40S NEP626	Nep	063677	SCAL80LD NEP626	Nep	071510
SCAL40S SAT605	Sat	064703	SCAL80LD SAT605	Sat	071506
SCAL40S SAT612	Sat	066158	SCAL80LD SAT612	Sat	071507
SCAL40S SAT613	Sat	063776	SCAL80LD SAT613	Sat	071508
SCAL40S SAT625	Sat	063671	SCAL80LD SAT625	Sat	071509
SCAL40S SAT626	Sat	031133	SCAL80LD SAT626	Sat	069720
Entrance Locksets			* SCAL80JD SAT626	Sat	067030
SCAL53LD NEP625	Nep	071501	Dummy Trim		
SCAL53LD NEP626	Nep	071502	SCAL170 SAT613	Sat	063780
SCAL53BD SAT626	Sat	071053	SCAL170 SAT625	Sat	063675
SCAL53LD SAT605	Sat	071499	SCAL170 SAT626	Sat	063774
SCAL53LD SAT612	Sat	071500			



L Series Mortise Locks

Certifications: ANSI A156.13 1987 Series 1000 Grade 1 operational, Grade 1 security. ANSI/ASTM, F476-76 Grade 40. U.L. Listed

Case Size: 4 7/16" x 6 1/16" x 1", 2 3/4" backset

Deadbolt: 1" throw stainless steel

Latchbolt: 3/4" throw stainless steel

Armored Front: 1 1/4" x 8" x 7/32"

Door Range: 1 3/4" standard

Lever: Forged brass or bronze

Rose: "A" 2 1/8" diameter wrought. "B" 2 9/16" diameter wrought.

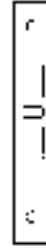

Armor Front

Mfg#	Description	EZ #
------	-------------	------

L9000 Series Mortise Lockset

SCL9010 06B626	Passage	074067
SCL9010 93B626	Passage	074068
SCL9040 06B626	Privacy	074057
SCL9040 93B626	Privacy	074058
SCL9050 L06B626	Office Less Cyl.	074059
SCL9050 L93B626	Office Less Cyl.	074060
SCL9070 L06B626	Classroom Less Cyl.	074061
SCL9070 L93B626	Classroom Less Cyl.	074062
SCL9080 L06B626	Storeroom Less Cyl.	074063
SCL9080 L93B626	Storeroom Less Cyl.	074064
SCL9453 L06B626	Entrance Less Cyl.	074069
SCL9453 L93B626	Entrance Less Cyl.	074070
SCL9453 L93N626	Entrance Less Cyl.	012618
SCL9473L03B626	Dormitory Less Cyl.	078595
SCL9473L06B626	Dormitory Less Cyl.	078596

L9000 Series Lock Body

SCL9010B BODY ONLY	Passage	012605
SCL9040B BODY ONLY	Privacy	064398
SCL9050LB BODY ONLY	Office	064399
SCL9070LB BODY ONLY	Classroom	064400
SCL9080LB BODY ONLY	Storeroom	012609
SCL9453LB BODY ONLY	Entrance	012613

Mfg#	Fits	EZ #
------	------	------

L9000 Series Trim

SC09 454 07A626	9010, 9070, 9080	064483
SC09 455 07A626	9040	064404
SC09 456 17A626	9050, 9453	064480

L9000 Series Armor Faceplates

SC09 663 626	9050, 9070, 9080	012656
SC09 666 626	9453	012657

L9000 Series Strikes

SC10 072 613	All Locksets	064411
SC10 072 626	All Locksets	012668

Mfg#	Description	EZ #
------	-------------	------

L9000 Series 1 1/8" Mortise Cylinders, "C" Keyway

SC30 001C 613	Oil Rubbed Bronze	064414
SC30 001C 625	Polished Chrome	064415
SC30 001C 626	Satin Chrome	064413

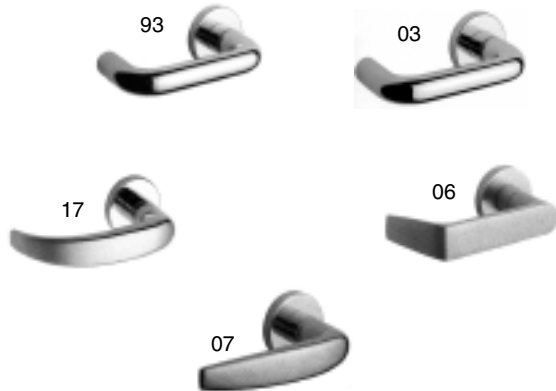

L9070 - Classroom

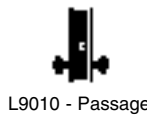

L9010 - Passage



L9080 - Storeroom

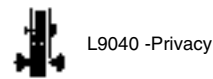

L9040 - Privacy

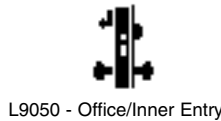

L9050 - Office/Inner Entry

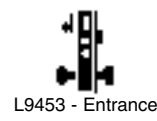

L9453 - Entrance

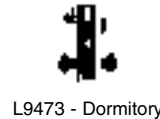

L9473 - Dormitory



BC100 Series Standard Duty

ANSI A156.5 Grade 2

- 6 pin tumbler cylinder, "C" keyway standard
- Fits doors 1 3/8" to 1 3/4" thick
- 1" throw deadbolt, adjustable for 2 3/8" and 2 3/4" backsets with concealed 1/4" dia. hardened steel roller
- 1" dia. reinforced trim ring rotates to protect against wrenching
- Strike: 1 1/8" x 2 3/4", square corner, box
- 2 1/2" adapter ring for 2 1/8" installation (1 1/2" standard)



Mfg. #	Fin.	Kwy.	EZ #
<i>Single Cylinder</i>			
SCBC160P605 KA4C 12 270	605	C	041988
SCBC160P609 KA4C 12 270	609	C	041989
SCBC160P612 KA4C 12 270	612	C	066027
SCBC160P613 KA4C12 270	613	C	027500
SCBC160P625 KA4C12 270	625	C	063726
SCBC160P626 KA4C 12 270	626	C	041990
SCBC160P6E 626 12 270	626	E 6 pin	012150
<i>Double Cylinder</i>			
SCBC162P605 KA4C 12 270	605	C	041991
SCBC162P609 KA4C 12 270	609	C	041992
SCBC162P612 KA4C 12 270	612	C	066028
SCBC162P613 KA4C12 270	613	C	029380
SCBC162P625 KA4C 12 270	625	C	063727
SCBC162P626 KA4C 12 270	626	C	041993
SCBC162P6E 626 12 270	626	E 6 pin	041994
<i>Turn Bolt - No Cylinder</i>			
SCBC180 626	626	N/A	012155
SCBC180 605	605	N/A	012153

B200 Series Night Latch

A deadlocking latch bolt which prevents "shimming" of the latch with credit cards, screwdriver or similar tool. B250 contains a "holdback" feature which retains the deadlatch in a retracted position when desired.

- Certification: ANSI A156.5 Grade 2
- Fits doors 1 3/8" to 1 3/4" thick
- Classic C keyway

Mfg. #	Fin.	Backset	EZ #
<i>Single Cylinder</i>			
SCB250PD605 2 3/8 KD C	605	2 3/8"	027506
SCB250PD626 2 3/8 KD C	626	2 3/8"	027507
<i>Double Cylinder</i>			
SCB252PD605 2 3/8 KD C	605	2 3/8"	027508
SCB252PD626 2 3/8 KD C	626	2 3/8"	027509



BC100/B200/600 Series Bolts

Mfg#	B.S.	Fin.	Series	Faceplate	EZ #	Mfg#	B.S.	Fin.	Series	Faceplate	EZ #
SC12 073 605	2 3/8"	605	B400/S200	1 1/8" x 2 1/4"	012705	SC12 631 605	2 3/4"	605	B600	1 1/8" x 2 1/4"	031030
SC12 073 626	2 3/8"	626	B400/S200	1 1/8" x 2 1/4"	012707	SC12 631 613	2 3/4"	613	B600	1 1/8" x 2 1/4"	064384
SC12 076 605	2 3/4"	605	B400/S200	1 1/8" x 2 1/4"	012708	SC12 631 626	2 3/4"	626	B600	1 1/8" x 2 1/4"	031031
SC12 076 626	2 3/4"	626	B400/S200	1 1/8" x 2 1/4"	012710	SC12 630 605	2 3/8"	605	B600	1 1/8" x 2 1/4"	031032
SC12 100 605	2 3/8"	605	B200	1 1/8" x 2 1/4"	012712	SC12 630 613	2 3/8"	613	B600	1 1/8" x 2 1/4"	064604
SC12 100 626	2 3/8"	626	B200	1 1/8" x 2 1/4"	027557	SC12 630 626	2 3/8"	626	B600	1 1/8" x 2 1/4"	031033
SC12 103 626	2 3/4"	626	B200	1 1/8" x 2 1/4"	012714	SC12 640 626	2 3/8"	626	B600	Drive-in	031034
SC12 237 605	Adj	605	B100	1" x 2 1/4"	012728	SC12 641 612	2 3/4"	612	B600	Drive-in	070014
SC12 237 626	Adj	626	B100	1" x 2 1/4"	012730	SC12 641 626	2 3/4"	626	B600	Drive-in	031035
SC12 239 626	Adj	626	B100	Drive-in	012731						
SC12 270 605	Adj	605	BC100	1" x 2 1/4" (multi plates)	075154						
SC12 270 613	Adj	613	BC100	1" x 2 1/4" (multi plates)	075153						
SC12 270 626	Adj	626	BC100	1" x 2 1/4" (multi plates)	075152						
SC12 274 605	Adj	605	BC100	1" x 2 1/4" (fixed plates)	073436						
SC12 274 626	Adj	626	BC100	1" x 2 1/4" (fixed plates)	073437						

B600 Series Heavy Duty

- ANSI A156.5 Grade 1 • Standard 6 pin tumbler cylinder, keyed 5 pin • Fits doors 1 5/8" to 2" thick
- 1" throw high-strength • Strike 1 1/8" x 2 3/4", square corner, box
- Wrought brass or bronze cyl. ring with steel reinforcing insert • Classic "C" keyway



Mfg. #	Backset	EZ #	Mfg. #	Backset	EZ #
<i>Single Cylinder</i>			<i>Double Cylinder</i>		
SCB660P 605 2 3/8 KA4 'C'	2 3/8"	061959	SCB662P 605 2 3/8 KA4 'C'	2 3/8"	061983
SCB660P 609 2 3/8 KA4 'C'	2 3/8"	061960	SCB662P 609 2 3/8 KA4 'C'	2 3/8"	061984
SCB660P 613 2 3/4 'C'	2 3/4"	061961	SCB662P 613 2 3/4 'C'	2 3/4"	061985
SCB660P 625 2 3/4 'C'	2 3/4"	061962	SCB662P 625 2 3/4 'C'	2 3/4"	061957
SCB660P 626 2 3/4 'C'	2 3/4"	061982	SCB662P 626 2 3/4 'C'	2 3/4"	061958
* SCB660J613 2 3/4	2 3/4"	066351	* SCB662J613 2 3/4	2 3/4"	066352
* SCB660J626	2 3/4"	063728	* SCB662J 626	2 3/4"	060117

Mfg. #	Desc	EZ #
<i>Thick Door Pack</i>		
SCB610 051 626	F/660	031156
SCB610 055 626	F/662	031160

J - 1/C Less Core

Cylinders (6 pin)

Mfg. #	Kwy	Desc	Fin	EZ #
<i>A Series</i>				
SC21 002C122 606	C	Orbit cyl.	606	071489
SC21 002C122 626	C	Orbit cyl.	626	012980
SC21 002E122 626	E	Orbit cyl.	626	012984
SC21 002F122 626	F	Orbit cyl.	626	027564
SC21 002C606	C	Except Orbit	606	071488
SC21 002C626	C	Except Orbit	626	012982
SC21 002E626	E	Except Orbit	626	012986
<i>Multipack fits A, AL, D & ND Series</i>				
SC40 100C606	C		606	072912
SC40 100C626	C		626	073594
SC40 100E626	E		626	073595
SC40 100F626	F		626	076691
SC40 100G 626	G		626	077905
<i>A Series Everest</i>				
SC21 002 122C123 606KD	C123	Orbit cyl.	606	071467
SC21 002 122C123 626KD	C123	Orbit cyl.	626	071261
SC21 002 122C145 626KA	C145	Orbit cyl.	626	071262
<i>AL Series</i>				
SC21 020C606	C		606	071491
SC21 020C626	C		626	071490
<i>D Series Knob Cylinders</i>				
SC23 001E626	E		626	012997
SC23 001E606	E		606	071494
SC23 001626FG	FG		626	083951
<i>D Series Lever Cylinders (NOT ND Series)</i>				
SC23 013C626	C		626	012991
SC23 013C606	C		606	071495
<i>Everest Deadbolt Cylinders</i>				
SC22 644C123 626KD	C123	Sgl Cyl B660	626	071479
SC22 644C123 606KD	C123	Sgl Cyl B660	606	071478
SC22 644C145 626KD	C145	Sgl Cyl B660	626	071480
SC22 645C123 606KD	C123	Dbl Cyl B662	606	071481
SC22 645C123 626KD	C123	Dbl Cyl B662	626	071482
SC22 645C145 626KD	C145	Dbl Cyl B662	626	071483

Mortise Cylinders

Mfg. #	Kwy	Length	Fin.	EZ #
<i>Schlage - with B502-191 standard cam</i>				
SC20 001C626	C	1 1/8"	626	012764
SC20 001E613	E	1 1/8"	613	042013
SC20 001E626	E	1 1/8"	626	012771
<i>Everest Mortise Cylinders - with B502-948 standard cam</i>				
SC20 001C123 118 613	C123	1 1/8"	613	073125
SC20 001C123 118 626	C123	1 1/8"	626	071092
<i>Everest Mortise Cylinders - with L583-153 "L" cam</i>				
SC30 021C123 605KD	C123	1 1/8"	605	071463
SC30 021C123 613KD	C123	1 1/8"	613	071462
SC30 021C123 626KD	C123	1 1/8"	626	071461
SC30 021C145 626	C145	1 1/8"	626	071464

Rim Cylinders

- Requires 1 5/8" bore for flush fit of trim collar.
- Stocked with horizontal cylinder bar

Mfg. #	Kwy.	Fin.	EZ #
SC20 022C605	C	605	012777
SC20 022C626	C	626	012779
SC20 022E626	E	626	012782
<i>Everest Rim Cylinders</i>			
SC20 022C123 605	C123	605	071093
SC20 022C123 613	C123	613	073128
SC20 022C123 626	C123	626	071094
SC20 022C145 605	C145	605	072810
SC20 022C145 613	C145	613	073129
SC20 022C145 626	C145	626	071260



Cylinder Bars

Mfg. #	Door Range	EZ #	Mfg. #	Door Range	EZ #
<i>Single Cylinder</i>			<i>Double Cylinder</i>		
SCB202 557	1 3/4" BC160P	012164	SCB202 370	1 7/16" - 1 1/2", 2" - 2 3/16" B252P	012162
SCB202 558	1 3/8", 1 3/4", 2" B250P	012165	SCB202 453	1 7/8" - 2" BC162BD 2 1/8" - 2 1/2" B662BD	012163
SCB610 044	1 3/8" - 2 1/2" B660P	031150	SCB220 032	1 3/8" - 1 3/4" BC162P	012166
SCXB11 990	1 3/4" - 2 1/4" BC160P	077736	SCB220 036	1 3/4" - 2 1/4" BC162P	012167
<i>Double Cylinder</i>			SCB610 045	1 3/8" - 2" B662P	031151
SCB202 269	1 3/8" - 1 3/4" BC162P 1 3/8", 2 1/4" B252P	012157	SCB610 046	2" to 2 1/2" B662P	031152
SCB202 369	1 5/8", 1 3/4", 2 7/8" - 3 1/8" B252P	012161	SCXB11 991	1 3/4" to 2 1/4" BC162P	077737



Tailpieces

I/C Components

Mfg #	EZ #	Mfg #	EZ #
<i>Mortise Housings</i>		<i>Full Size I/C Cores</i>	
SC26 090 605	066348	SC23 030C626	013001
SC26 090 613	066349	SC23 030E626	027863
SC26 090 626	065645	SC23 030F626	069870
SC26 097 626	071234	SC23 030G 626 O BITT	039555
<i>Rim Housings</i>		<i>Adams Rite Cam</i>	
SC20 079 626	067031	SCK510 711A/R	066350
<i>Everest Full Size I/C Cores</i>		<i>Sargent Cam</i>	
SC23 030C123 606	072807	SCB520 296	070193
SC23 030C123 626	073317	<i>Corbin Russwin Cam</i>	
SC23 030C145 606	072808	SCB520 253	070194
SC23 030C145 626	072809	<i>Standard Cam</i>	
		SCK510 730	037095

Pins

Mfg #	Desc.	EZ #	Mfg #	Desc.	EZ #
SC34 103	#3 top	013062	SC34 302	#2 bottom	013083
SC34 202	#2 master	013073	SC34 303	#3 bottom	013084
SC34 204	#4 master	013075	SC34 304	#4 bottom	013085
SC34 205	#5 master	013076	SC34 305	#5 bottom	013086
SC34 206	#6 master	013077	SC34 306	#6 bottom	013087
SC34 208	#8 master	013079	SC34 307	#7 bottom	013088
SC34 300	#0 bottom	013081	SC34 308	#8 bottom	013089
SC34 301	#1 bottom	013082	SC34 309	#9 bottom	013090

Key Blanks

Mfg. #	EZ #	Mfg. #	EZ #	Mfg. #	EZ #
SC35 056C	013091	SC35 101C	013102	<i>Everest</i>	
SC35 056E	028688	SC35 101CE	013103	SC35 003C123	071451
SC35 100C	013092	SC35 101E	013104	SC35 003C145	071452
SC35 100CE	013093	SC35 101EF	013105	SC35 009C100	071487
SC35 100E	013094	SC35 101F	013106	SC35 009C120	071485
SC35 100EF	013095	SC35 101FG	013107	SC35 009C123	071258
SC35 100F	013096	SC35 101G	027580	SC35 009C124	071484
SC35 100G	052020	SC35 101H	013108	SC35 009C135	071447
SC35 100H	013098	SC35 101J	013109	SC35 009C145	071259
SC35 100J	013099	SC35 101L	013111	SC35 009C150	071486
SC35 100K	013100				

Cylinder Plugs

Mfg. #	Kwy	Fin	EZ #
<i>A-S Series and Rim Cyl-5 PIN</i>			
SC33 005E626	E	626	013044
<i>A-S Series and Rim Cyl-6 PIN</i>			
SC33 006C626	C	626	013049
SC33 006E626	E	626	013051
SC33 006F626	F	626	013053
<i>Everest Mortise Cylinder Plugs</i>			
SC33 229C124 118 626	C124	626	071476
SC33 229C135 118 626	C135	626	071477
<i>Everest A-S Series & Rim Cylinder Plugs</i>			
SC33 230C124 626	C124	626	071474
SC33 230C135 626	C135	626	071475



Miscellaneous Parts

Mfg #	Desc.	EZ #
SCB220 030 626	Rose and turn for B160 series	042016
SC36 083 626	Adjustable spring collar	073408
SC38 016 609	Adapter ring (2) kit for B162 deadbolt w/ 2 1/8" bore	042015
SC10 001 626	T strike for A Series	012660
SC10 001 613	T strike for A Series	071492
SCB220 186 605	B160 deadbolt screw pack	012171
SCB220 052 605	B162 deadbolt screw pack	012168
SCL583 255	L series cam for I/C cylinder	065644
SCL583 254	L series cam for mort cylinder	012601
SCB520 233	C/R cam for mort cylinder	070191
SCB502 191	Stand. cam for mort cylinder	070190
SCB520 256	Sargent cam for mort cylinder	070189
SCB502 292	A/R cam for mort cylinder	070188

Everest Cylinder Multi-Pack

Fits A, AL, D & ND Series

Mfg. #	EZ #
SC40 100C123 606	073318
SC40 100C123 626	073319
SC40 100C145 606	073320
SC40 100C145 626	073321



Primus Restricted Locksmith Keyway

Primus restricted keyways are available on a limited basis to authorized Level 1+ and Level 7 locksmith dealers. Keys are stocked by the locksmith, and keying is controlled by the locksmith. Opening stock order for Level 1+ is \$1500 dealer net. For Level 7, opening stock order is \$1500 dealer net. Limited areas are available. If you're interested in becoming a Schlage Primus dealer, call IDN for more information.

KIK Cylinders, IC Cores & Deadbolt Cylinders

Mfg #	Fin	Kwy	Level	EZ #
<i>Standard Cores - Schlage I.C.</i>				
SC20 740 1460 CP626LKB	626	C	1 +	063704
SC20 740 1460 CP606LKB	606	C	1 +	066347
<i>"A" Series Cylinders - ORBIT</i>				
SC20 724 1001 CP626LKB	626	C	1	064785
* SC20 724 1460 CP606LKB	606	C	1 +	063699
* SC20 724 1460 CP626LKB	626	C	1 +	063700
+ SC20 724C123 004805 626	626	C	7	076893
<i>AL Series Cylinders</i>				
+ SC20 728C123 004805 626	626	C	7	076897
<i>"B" Series Cylinders - BC100/250/400 Single Cylinder (trim rings and driver bars not included)</i>				
SC20 729 1001 CP626LKB	626	C	1	064786
SC20 729 1460 CP606LKB	606	C	1 +	063701
SC20 729 1460 CP626LKB	626	C	1 +	063702
+ SC20 729C123 004805 626	626	C	7	076898
<i>"B" Series Cylinders - B660</i>				
SC20 744 1460 CP626LKB	626	C	1 +	064602
<i>"D" Series Knob Lock Cylinders</i>				
SC20 748 1001 CP626LKB	626	C	1	064787
<i>"D" Series Knob Lever Cylinders</i>				
SC20 750 1001 CP626LKB	626	C	1	064788
SC20 750 1460 CP606LKB	606	C	1 +	063707
SC20 750 1460 CP626LKB	626	C	1 +	063708
+ SC20 750C123 004805 626	626	C	7	076894

Mortise Cylinders and Rim Cylinders

Mfg #	Fin	Kwy	Level	EZ #
<i>Mortise Cylinders</i>				
SC20 706 1001CP605LKB	605	C	1	064779
SC20 706 1001CP613LKB	613	C	1	064780
SC20 706 1001CP626LKB	626	C	1	064781
SC20 706 1460CP605LKB	605	C	1 +	063695
SC20 706 1460 CP626LKB	626	C	1 +	063696
SC20 706 1460CP613LKB	613	C	1 +	065802
+ SC20 700C123 004805 613	613	C	7	077010
+ SC20 700C123 004805 626	626	C	7	076895
<i>Rim Cylinders - Horizontal Tailpiece</i>				
SC20 710 1001CP613LKB	613	C	1	064783
SC20 710 1001CP626LKB	626	C	1	064784
SC20 710 1460CP605LKB	605	C	1 +	063697
SC20 710 1460CP626LKB	626	C	1 +	063698
SC20 710 1460CP613LKB	613	C	1 +	065803
+ SC20 710C123 004805 626	626	C	7	076896



20-706:
A/R Cam

20-700:
Straight
Cam

* Use driver A301 337 on 20-724 with designs other than Orbit.
+ C123 004805 = Primus / Everest Level 7

Key Blanks

Mfg #	Desc.	EZ #
SC35 157 1001CP	Level 1	028594
SC35 157 1460 CP	Level 1	064532
SC35 004C123 004805	Level 7 Prim/Ever	076892
SC35 157CP1038	Primus 1038	074744
SC35 158CP	Primus Cntrl	063720



I.D. Cards

Mfg #	Level	EZ #
SC40 061	1	028566
SC40 065	1 +	(special order)
SC40 060 004805	7 Prim/Ever	076886



Primus & Everest Parts

Mfg #	Desc.	EZ #
SC40 070	Primus pin kit (finger pins)	061583
SC34 001	#1 finger pin	063668
SC34 002	#2 finger pin	013054
SC34 003	#3 finger pin	064197
SC34 004	#4 finger pin	013055
SC34 006	#6 finger pin	013056
SC34 007	Everest check pin	071448
SC40 066	Primus plug Holder	013143
SCC603 951	Prim finger/Ever check pin spring	012210
SCC603 952	Primus side bar spring	012211
* SCA301 337	A & H tailpiece	012137
* SCA301 338	A & H tailpiece (Orbit)	012138
* SCA301 339	A & H tailpiece (A73 Orbit)	063713
* SCA700 031	AL tailpiece	063039
* SCA700 015	Plastic insert for "AL"	067349
* SCB502 949	Everest/Primus driver	012185
* SCC603 524	"D" knob tailpiece	012208
* SCC604 243	"D" lever tailpiece	012212
* SCS605 231	"S" lever tailpiece	063667
* SCB610 084	Sgl cylinder tailpiece F/B660	062201
* SCB610 085	Dbl cylinder tailpiece F/B662	062190
* SC47 395	Padlock driver	063722
SCB502 944	A/R Cam	012182
SCB520 309	Corbin Russwin cam	012646
SCL583 153	"L" concealed cylinder cam	012600
SCB502 948	Concealed cylinder standard cam	012184
SCB520 329	Sargent/Yale cam	070192

* Will work w/ Primus & Everest cyl LKB: Less Key Blank, "0" Bitted



Extra comp® 26SA

- 3500 Card Capacity
- Inexpensive, Self-contained
- Patented slotless Touch Card Reader
- No control panels or secondary electronics
- Extremely easy to install
- Low power consumption
- Non-volatile memory
- Timed anti-passback



The EXTRA COMP® 26SA card access control unit utilizes state of the art electronics in providing a unit that is both inexpensive and fully programmable. The patented slotless TOUCH CARD® reader is protected from weather and vandalism. Simply place the card on the stainless steel touch plate and the card is read instantly and errorlessly. A green light indicates that access has been granted. Because the EXTRA COMP® 26SA has non-volatile memory, reprogramming after a power loss is a thing of the past. Validating and voiding of cards as well as other programming functions are easily accomplished from outside the housing using a few programming cards. The complete unit easily surface mounts to a single gang electrical box, masonry wall, post, or almost any surface. The EXTRA COMP® 26SA operates on low voltage, AC or DC, and consumes less than 200 milliamps.



Entracomp® 28SA

- Up to 65,000 card capacity
- Timed anti-passback
- Optional second reader
- Modem compatible
- Communicates with a printer, terminal or PC
- Patented Touch Card® Reader technology
- Door monitor, remote open, remote inactive, arming circuit, tamper bell, or user defined programmable inputs
- Up to 5,800 date & time stamped transactions stored
- Up to 16,000 limited use card capacity
- Up to 15 card time zones and 1 door unlock time zone
- 32 holidays • Automatic daylight savings time



The 28SA is a highly sophisticated, yet simple to use, single passageway card access control unit. Utilizing patented slotless TOUCH CARD® Reader technology, the unit is protected from weather and vandalism. Simply place the card on the stainless steel TOUCH CARD® Reader plate, and the card is read instantly and errorlessly – in any weather. Since the 28SA has non-volatile memory, it is not necessary to reprogram the unit after a power loss. The unit may be programmed via a terminal or PC either locally or with the use of a modem, telephonically. Programming of cards, as well as most other programming functions, may also be accomplished from outside the unit using a few inexpensive programming cards. Transaction information is stored by the unit and may be downloaded to a terminal, PC or printer. Three inputs are provided which are each user programmable as Door Monitor, Tamper Monitor, Remote Inactive, Remote Open, Arming Circuit, Bell, or User Defined. A second “slave” reader may be added to the 28SA to allow access control in both directions through a passageway. The limited use feature allows cards to be programmed to work for a given number of days, a given number of days after the first use or a given number of times.

Radio Key® RK-WM & RK-WS

- Up to 6” reading distance for RK-WM, 8” for RK-WS
- Wiegand formats - up to 40 bits
- DYNASCAN® Technology
- Extreme weather resistance
- Inexpensive • Easy to install
- LED and buzzer • Vandal Resistant



Designed to integrate into any system requiring a Wiegand output. The readers will read Secura Key proximity cards or key tags and transmit the data in virtually any Wiegand Format up to 40 bits. These completely potted units are rated for extreme weather use and are vandal resistant. Installation is easy. Two screws mount the unit to a mullion, masonry wall, post or almost any surface.

SK-ACP Advanced Control Panel

- Supports 2 Wiegand output card readers
- 4,800 date & time stamped stored events
- 65,000 card capacity
- 32 programmable holidays
- 15 programmable time zones with weekly schedule plus holidays
- Over 100 panels can be linked to a PC with SK-NET software using a simple RS-485 bus
- Modem capability for remote locations



Accepts readers that have a Wiegand output with almost any card technology, including Proximity, Touch Card, Wiegand, Magnetic Stripe, Bar Code, Optical and Biometric. Each of the two controlled doors is independent of the other and is configured, programmed and viewed separately. Each has a separate node address. Each door has two programmable inputs which may be programmed to function as a door open, remote inactive, door monitor, tamper, arming circuit, door unlock or user defined input.

Mfg#	Description	EZ #
SJ26SA	Stand Alone Card Access Unit (Includes mount housing and timed anti-passback)	028997
SJ28SA	Stand Alone Card Access Unit (Includes mount housing and timed anti-passback)	037145
SJRK WM	Prox reader 26 bit mullion	070012
SJRK WS	Prox reader 26 bit single gang electrical box	070533
SJRKKT02 26BIT	Prox key tag (Wiegand)	070535
SJRKCM02 26BIT	Prox reader card (Wiegand)	070534
SJSK ACP	Two door access control panel	070013
*SJSKC06A50PK	Solid vinyl card deck (50 pk)	029001
*SJSKC06B100PK	Solid vinyl card deck (100 pk)	029000
*SJSKC06C 250PK	Solid vinyl card deck (250 pk)	042017
<i>* Includes standard printing, sequential numbering, sequential encoding, and programming deck</i>		
SJSK029W	Slave Reader	037147
SJRK GM	Glass Mounting Kit	071138



RADIO KEY 600

Stand Alone Proximity Access Control Keypad Access Control

Radio Key 600 is a fully-programmable single-door access control system, providing state-of-the-art proximity technology.

To use **Radio Key 600**, simply hold your key tag near the Access Control Unit or the Optional Auxiliary Reader. A green light and audible beep indicate that access has been granted. A red light and three short beeps indicate that the key tag is not valid. Key tags are



validated by using the Access Control Unit's programming keypad and holding each key tag near the unit or entering its number. Key tags can also be voided or validated by using the keypad, without the tags being present.

Radio Key 600 consists of a compact, weather resistant, surface mounted Access Control Unit, which contains an internal reader. It can stand-alone for most applications.

The optional Auxiliary Reader provides extraordinary protection against weather and vandalism. Entry cannot be obtained by tampering when the Auxiliary Reader is externally mounted. For further protection, the Access Control Unit and Auxiliary Reader can be mounted behind glass, plastic, wood paneling, plasterboard or other non-metallic wall surfaces. When installed with the Auxiliary Reader, the Access Control Unit can be used as an exit reader and as an enrollment reader. Either unit easily mounts to a single-gang electrical box, masonry wall, post, or almost any surface -- there are no bulky control panels to install.

- **Low Priced Single-Door Proximity and Keypad Entry System**
- **Void/Valid Capability for up to 600 Proximity Key Tags or Pins**
- **Access Control Unit Includes Built-in Reader and Programming Keypad**
- **Optional Auxiliary Reader for High-Security/Extreme Weather Conditions**
- **Easy to Install, Low Profile, Surface Mounted**
- **High Security - Entry Cannot Be Obtained by Tampering With Auxiliary Reader**
- **Up to 6" Reading Distance**
- **Password Protected Programming**
- **DC Power Supply Included**
- **Stand-Off Spacer Included for Mounting on Metal Surface**

SJRK600T

Reader
EZ # 065298

SJRKAR

Auxiliary Reader
EZ # 065264

SJRKKT01 10

Pk of 10 Key Tags
EZ # 065265

SJCBLSA

Cable F/ Laptops
EZ # 029626

SJRKAT

Audit Trail Upgrade
EZ # 066404



SJSK NM485

Network Module
For 28SA Plus
EZ # 069636



Mortise Glass Lock

Model 62 Magnalock

Security and Life Safety

- Over 1200 pounds of certified electromagnetic holding power.
- Measures: 8" x 3" x 1 3/4"
- Efficient 3-watt power consumption. (125 mA at 24VDC, or 250 mA at 12VDC.)
- UL recognized for use on emergency exit doors.
- Instantaneous unlocking with no residual magnetism.
- Fail-safe design, however, a small battery will run lock for hours.
- Optional SENSTAT™ lock status sensor assures the lock is holding at full force.
- Vandal and weather resistant with attractive stainless steel case.
- Brushed stainless steel, for special finish applications use dress covers.

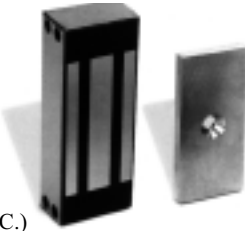

Mfg #	Voltage	EZ #
<i>Standard Model</i>		
SN62 12/24VDC	12/24VDC	069376
<i>F – Face drilled for inswinging door (order with z bracket)</i>		
SN62F 12/24VDC	12/24VDC	069378
<i>GF – Face drilled w/conduit fitting (order with z bracket), 1/2" ID, 3/4" OD pipe thread</i>		
SN62GF 12/24VDC	12/24VDC	069380
<i>G – Conduit fitting, universal (1/2" ID, 3/4" OD pipe thread)</i>		
SN62G 12/24VDC	12/24VDC	069379
<i>SC – Senstat-form C</i>		
SN62SC 12/24VDC	12/24VDC	069746

Model 32 MiniMag

Traffic Control

- Over 600 pounds of certified electromagnetic holding power
- Suitable for traffic control - not intended for security doors
- Compact size: 8" x 1 7/8" x 1 1/2"
- Vandal and weather resistant stainless steel case
- Efficient 3.5 watt power consumption. (150 mA at 24 VDC, or 300 mA at 12 VDC)



Mfg #	Voltage	EZ #
<i>Standard Model</i>		
SN32 12VDC	12VDC	028117
SN32 24VDC	24VDC	028116
<i>F - Face drilled for inswing door (order w/z-bracket)</i>		
SN32F 12VDC	12VDC	042025
SN32F 24VDC	24VDC	042026

Mortise Glass Lock

- Electric locking for narrow stile aluminum frame glass doors
- Installs in existing ANSI opening
- Fail secure • UL Listed
- Accepts 1" mortise cylinder for mechanical override



Mfg # SNMGL24 (24VDC) EZ # 080704

Model 82 Magnalock

Highest Security Needs

- Over 1,800 pounds of electromagnetic holding force.
- Vandal/Weather resistant stainless steel case.
- Efficient 4-watt power consumption, (175 mA @ 24 VDC, 350 mA @ 12 VDC).
- New Senstat lock status design included, SPDT dry output. Switches when lock loses power and/or the armature loses contact.
- New solid state patented instant release/noise suppression circuit. No suppression electronics needed for sensitive access control/alarm equipment.
- Measures: 12" x 3" x 1 3/4"



Mfg #	Voltage	EZ #
SNM82SC12/24VDC	12/24VDC	068376

Magnalock Accessories

Dress Covers

Mfg # SNDC62BK	Black anodized	EZ # 013337
Mfg # SNDC62BP	Polished Brass	EZ # 028077

Z-Bracket For Inswinging Door

(includes fasteners & cover)

Mfg # SNZ62CL	Clear anodized	EZ # 013348
Mfg # SNZ32CL	Clear anodized	EZ # 029208

Universal Header Brackets (1" x 9 1/2" x 1 1/2")

Mfg # SNUHB CL	Clear anodized	EZ # 028193
----------------	----------------	-------------

NOTE: 1" and/or 1 1/2" extension. Room for wire splicing.

Aluminum (Spacer) Bracket

Mfg # SNASB32CL	For 32 lock (clear)	EZ # 067021
Mfg # SNASB62CL	For 62 lock (clear)	EZ # 067022

Header Extension Brackets

Mfg # SNHEB 2CL	2" x 2" x 8"	EZ # 013345
Mfg # SNHEB 3CL	3" x 3" x 8"	EZ # 027592

Replacement Strike Plate

Mfg # SNASS82	Split strike set (82 lock)	EZ # 067023
Mfg # SNAPS62	Strike Plate for 62	EZ # 042031

Stop Filler Plates

Mfg # SNSFP 1/2CL	1/2" x 1 1/4" x 8"	EZ # 027597
Mfg # SNSFP 5/8CL	5/8" x 1 1/4" x 8"	EZ # 027598

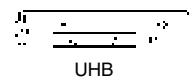

UHB

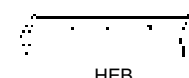

HEB

ASS82

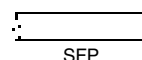

SFP

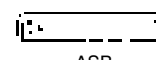

ASB

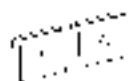

Digital Entry System (DK-26)

- High Security Keypad. Central Processor Unit mounts inside the protected area. Attacking the keypad will not release the lock.
- Rugged Cast stainless steel keypad fits narrow stile frames. Standard and tamper proof screws provided. Ideal for high traffic installations.
- 59 Codes. • Powerful Features. Easy to install, program and operate.
- Operates on 12 or 24 Volts, AC or DC. Operates any electric lock/gate (5 amp max). Lock release adjustable from 1 to 99 seconds or in toggle (on/off) mode. Exit request input (REX) standard.
- Includes signaling LEDs and audible output. Can be modified for quiet operation or specialized applications.
- True 10 digit code operation. Millions of code possibilities • Built-in doorbell and alarm functions.
- Non-Volatile EEPROM programming and user code memory
- Heavy duty spy shield available on special order



Mfg. #	Description	EZ #
SNDK26SS	Keypad Access System	060615
SNDK26BK	Keypad Access System (black)	060617
SNDK26PSS	Keypad Only	060616

Stand Alone Digital Entry (DK-11)

- Durable American Made keypad with numbers that won't wear off • Ideal for high traffic installations
- Heavy duty stainless steel face plate • Flush mount back box with both standard and tamper proof screws
- Four entry codes – 2 to 7 digits in length. Millions of code possibilities • True 12 digit keypad
- Exit request input (REX) • Non-volatile EEPROM memory storage without the use of batteries

Mfg # SNDK11 EZ # 031185



TSB3 Touch Sense Bar™

The TSB3 is the perfect exit device to meet the prior knowledge for use requirement. Using patented technology, the simple act of touching the bar (even through gloves or clothing) trips an electronic sensor which immediately releases the electric lock.

Many card reader applications call for free egress which requires a request-to-exit signal to the control electronics. Activating the TSB energizes a DPDT 2Amp relay which both releases the lock and signals the access control system. For even greater flexibility, the sensor operates on 12-24 volts, DC.

The TSB outperforms mechanical products, including switch-equipped panic bars. There are no moving parts to wear out and no requirements for periodic maintenance or replacement. In the unlikely event of sensor failure, there is a redundant push switch mounted on the rear of the bar.



Mfg # SNTSB3CL	Alum. Touch Sense Bar	EZ # 042041
Mfg # SNTSB3BK	Black Touch Sense Bar	EZ # 042042
Mfg # SNTS3	Replacement Sensor(TSB3)	EZ # 061991
Mfg # SNTSB C	Door Cord	EZ # 061990
Mfg # SNTS2	Rep. Sensor for TSB1	EZ # 029173

- Length of bar can be field modified. Supplied for 36" wide door (up to 48" is available by special order)
- Not handed
- Comes with mounting fasteners and door cord
- UL Listed as part of Exit Control System

Touch Sense Handle

Unique Touch Sense Technology in a Convenient Handle Design for Releasing any Electromagnetic Lock.

- Simple act of grabbing or pushing on the handle releases the electromagnetic lock.
- Dual redundancy switch built-in. • Engraved plates indicating Pull or Push with blank plates in Black or Gray.
- 16 feet of cable with connector provided. Door cord included.

Mfg # SNTSH CL	Alum Touch-Sense Handle	EZ # 062461
Mfg # SNTSH BK	Black Touch-Sense Handle	EZ # 062462

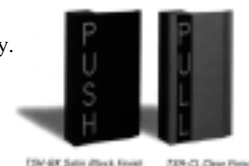

Exit Buttons

PB Series (special duty 7 Amp)

Round 1 1/2" illuminated button 12/24VDC.

Mfg # SNPB Momentary, single gang EZ # 027874

PB2 Series (heavy duty 10 Amp)

Square 2" illuminated button, 12/24VDC. SPDT contacts.

Mfg # SNPB2 Momentary, single gang EZ # 027740

PB3 Series (general duty 3 Amp N.O.& N.C. contacts)

Rectangular 3/4" x 1" illuminated button, 12/24VDC.

Mfg # SNPB3N Momentary, narrow EZ # 028731



PB



PB2



EEB2



PB3

PB2E Series (heavy duty 10 Amp SPDT contacts)

Square 2" button - non-illuminated. Backbox not included.

Mfg # SNPB2E Momentary, single gang EZ # 027741

EEB2 Series (3 Amp SPDT contacts)

Emergency Exit button

Single gang

Mfg # SNEEB2 EZ # 067612

MK Series (mortise) UL Listed Key Switches

Accepts a user supplied mortise cylinder. (1 1/8" or 1 1/4") and can use 1 (included) or 2 (optional) switches. Bi-color LED, 12/24VDC.

Momentary, single gang

Mfg # SNMK EZ # 028798

Alternate, single gang

Mfg # SNMKA EZ # 046261

Momentary, narrow style

Mfg # SNMKN EZ # 028799

Alternate, narrow style

Mfg # SNMKAN EZ # 029210

Momentary, replacement switch only

Mfg # SNMKS EZ # 029175



XDT Series Exit Delay Timer

Designed to meet NFPA-101 Life Safety Code, for special locking arrangements. Requires regulated DC voltage.

Mfg # SNXDT24 24VDC EZ # 061987

Time delay module in metal enclosure

Mfg # SNBAXDT24 24VDC EZ # 029129



XDT24

Prime Time Digital Timer

7 day digital programmable timer 12/24VAC or VDC operation. 10Amp DPDT contacts.

Mfg # SNDT7 EZ # 027586



DT7

Motion Detector

Passive infrared request-to-exit device for magnetic lock release. Operates 12 to 24 VDC (filtered or regulated)

Mfg # SNXMS EZ # 065795



BR-7 Bridge Rectifier

Potted with 4 color coded leads 7 amp cap. Converts AC to DC voltage. 12 or 24VDC

Mfg # SNBR7 EZ # 013335



TM-9 Timemate Timer

Release hold timer, SPDT 3 amp contacts, non retriggerable input, 1-36 Sec. adjustable, 12/24VDC, 24VAC.

Mfg # SNTM9 EZ # 028372

BPS Series Power Supplies

- Regulated DC power supply • Battery charging capability
- Fused AC inputs • Fire alarm interface
- All UL components • LED power indicator

Mfg # EZ # Amp

Mfg #	EZ #	Amp
12VDC, 12" x 9" x 4"		
SNBPS12 1	013333	1
12VDC, 14" x 14" x 4"		
SNBPS12 3	042022	3
24VDC, 12" x 9" x 4"		
SNBPS24 1	060204	1
24VDC, 14" x 14" x 4"		
SNBPS24 2	029176	2
SNBPS24 3	042023	3
24VDC, 15" x 18" x 6"		
SNBPS24 6	029130	8



Unlatch

Releases latch by pushing it out of the strike while at the same time maintaining deadlatch security. Will operate under 30 pounds of pre-load and guaranteed to maintain a sound strike mechanism under rigorous use.

Mfg # SNUNL12 (12VDC) EZ # 067884

Mfg # SNMUNL12 (mort.12VDC) EZ # 075914

Mfg # SNMUNL24 (mort. 24VDC) EZ # 075867



Shear Aligning Magnalock

Permits concealed mounting in aluminum, wood and steel doors for the ultimate in finished appearance. Both the magnet and strike plate assembly takes up only 1 1/2" width in the door and door frame.

Mfg # SNSAM EZ # 067882

With Senstat

Mfg # SNSAMSC EZ # 067883





Keepsake Safes • Media Safes

File Drawer • Wall/Floor Safes

Media Chest

- Space-saving organizer lifts out for desktop use
- Key-lock for privacy
- Convenient carrying handle
- Manufacturer's 3-year limited warranty
- Lifetime after-fire replacement guarantee
- Proven UL classified 1/2-hour fire protection



Mfg # UZ1710 EZ # 066414

Int. Dim.	Ext. Dim.	Capacity	Wt
4 3/8" x 14" x 5 7/8"	8 1/8" x 14 1/4" x 11"	.12 cu. ft.	29 lbs.

Media File

- Space-saving organizer lift out for desktop use. Holds audio cassettes, 3 1/2" & 5 1/4" diskettes, 5" & 6" data cartridges & CDs
- Proven UL-rated 1/2-hour fire protection up to 1550° F, maintains safe interior temperatures below 125° F & 80% humidity
- Manufacturer's 3-year limited warranty
- Lifetime after-fire replacement guarantee
- Lid with gasket for air-tight protection
- Key-lock for privacy



Mfg # UZ6720 EZ # 066415

Int. Dim.	Ext. Dim.	Capacity	Wt
8 1/8" x 9 3/4" x 6 3/8"	13 9/16" x 15 1/4" x 12 1/8"	.29 cu. ft.	55 lbs.

Wall Safe

- Reversible door-install to open from the right or left
- Dual protection with combination & key lock
- 2 removable shelves • Key rack (3 hooks)
- 2 live locking bolts secure door
- Key rack and compartment for small items
- Manufacturer's 3-year limited warranty



Mfg# UZ7150 EZ # 066425

Int. Dim.	Ext. Dim.	Capacity	Wt
13 7/8" x 13 7/8" x 3 3/4"	15 7/8" x 15 7/8" x 4"	.39 cu. ft.	22 lbs.

Fire-Safe Two Drawer File

- Manufacturer's 5-year limited warranty
- Lifetime after-fire replacement guarantee
- Proven UL classified 1-hr fire protection
- Seamless exterior construction
- Dual-latching system
- Holds standard, legal & A4 size documents



Mfg # UZ6000 EZ # 066411

Keepsake Chest

- Key-lock for privacy
- Convenient carrying handle
- Manufacturer's 3-year limited warranty
- Lifetime after-fire replacement guarantee
- Proven UL classified 1/2-hour fire protection



Mfg # UZ1110 EZ # 066412

Int. Dim.	Ext. Dim.	Capacity	Wt
3 1/2" x 12" x 7 1/2"	6 1/8" x 14 1/4" x 11"	.18 cu. ft.	17 lbs.

Keepsake Organizer

- Multi-layer organizing trays with lid and interchangeable divider
- Proven UL classified 1/2-hour fire protection
- Convenient carrying handle
- Easy-lift lid with organizer
- Key-lock for privacy
- Manufacturer's 3-year limited warranty
- Lifetime after-fire replacement guarantee



Mfg # UZ1160 EZ # 066413

Int. Dim.	Ext. Dim.	Capacity	Wt
3 13/16" x 13" x 8 5/8"	6 1/4" x 15 1/4" x 12 1/8"	.25 cu. ft.	19 lbs.

Floor Safe

- 4 number combination lock
- 12 gauge steel body
- Double locking bolts
- Heavy, die-cast aluminum door
- Manufacturer's 3-year limited warranty



Mfg # UZ7250 EZ # 066426

Int. Dim.	Ext. Dim.	Capacity	Wt
8 8/32" x 10 1/2"	9 9/16" x 15 23/32"	.31 cu. ft.	28 lbs.

Fire-Safe Office Safes

- 1.2 cubic feet capacity
- Door storage pocket
- 4 live locking bolts secure door
- Interior multi-position shelf (UZS3861 comes with two shelves)
- Key rack and compartment for small items
- UL classified 1-hour fire protection
- Manufacturer's 5-year limited warranty
- Lifetime after-fire replacement guarantee



UZS3421
w/ combo lock

Mfg#	Lock	EZ#
UZS3421	Combo	067627
UZS3861	Electronic	067628

Int. Dim.	Ext. Dim.	Capacity	Wt
13 3/4" x 12 9/16" x 11 7/8"	17 27/32" x 16 11/32" x 18 19/32"	1.2 cu ft	99 lbs

Steal-Safe Security Safes



Office/Business Safes • Concealed Safes

Steal-Safe™ Security Safe

- Solid steel construction
- Concealed hinges • Removable shelf
- May be bolted to floor or wall
- Double lock: key & combination



Mfg # UZV530 Combo EZ # 069557
Mfg # UZV560 Electronic EZ # 071073

Int: 11 7/8" x 16 3/4" x 11 7/8" Ext: 12 3/8" x 17" x 15 3/4" (15 1/2" V560)
Capacity: 1.3 cu. ft. Weight: 58.6 lbs.

Steal-Safe™ Security Safe

- Solid steel construction
- Concealed hinges
- Many be bolted to floor or wall
- 4-bitted key lock for greater security



Mfg # UZV120 EZ # 069556

Int: 6 1/4" x 12 1/8" x 9 1/4" Ext: 6 1/2" x 12 3/8" x 11"
Capacity: .4 cu. ft. Weight: 24.3 lbs.

Steal-Safe™ Security Safe

- Solid steel construction • Concealed hinges • Removable shelf
- May be bolted to floor or wall • Double lock: key & combination



Mfg # UZV330 Combo EZ # 070038 Mfg # UZV360 Electronic EZ # 071072

Int: 11 1/16" x 14 11/16" x 9 1/16" Ext: 12 3/16" x 14 15/16" x 12 5/8" (12 1/16" V330) Capacity: .9 cu. ft. Weight: 47.2 lbs.

Fire-Safe Office Safes

- 1.6 cubic feet capacity • Added capacity & hanging file rack
- \$50,000 fire protection guarantee
- Lifetime after-fire replacement guarantee • UL classified 2-hour fire protection



Mfg#	EZ#	Lock	Int. Dim.	Ext. Dim.	Capacity	Wt
UZA4487	070528	Combo	16 3/16" x 14 13/16" x 11 7/8"	20 9/32" x 18 19/32" x 18 19/32"	1.6 cu. ft.	185 lbs.
UZA4887	070529	Electronic				

UZA4887 w/ electronic lock

Fire-Safe Business Safes

- 2.0 cubic feet capacity • Bolt-down capability • Seven live-locking bolts • Water resistant
- \$50,000 fire protection guarantee • Lifetime after-fire replacement guarantee
- UL classified 2-hour fire protection



Mfg#	EZ#	Lock	Int. Dim.	Ext. Dim.	Capacity	Wt
UZA5489	070530	Combo	19 21/32" x 14 13/16" x 11 7/8"	23 3/4" x 18 19/32" x 18 19/32"	2 cu. ft.	180 lbs.
UZA5889	070531	Electronic	19 21/32" x 14 13/16" x 11 7/8"	23 3/4" x 18 19/32" x 18 19/32"	2 cu. ft.	206 lbs.

UZA5889 w/ electronic lock

Safe Concealment Cabinet

- Provides added sense of security when safe guarding important document & valuables
- Conceals safes up to 1.2 cu. feet • Elegant arched front and sculptured top
- Adjustable shelf - 2 positions for added organization
- Open bottom allows safe to be bolted to floor
- Functional height for use as an end table • Raised handle for easy access



Mfg# UZHKDC EZ # 067634

Int. Dim.	Ext. Dim.	Capacity	Wt
22 1/8" x 19 1/4" x 20 1/4"	23 1/8" x 22" x 24"	5.0 cu. ft.	52 lbs.

Accessories

Mfg #	EZ #	Int. Dim.	Ext. Dim.	Wt.
UZ901	067631	1 1/2" x 11 7/8" x 9 17/32"	1 5/8" x 12 1/2" x 10 1/2"	12 oz.
UZ902	067632	2 1/32" x 11 7/8" x 8 29/32"	2 7/8" x 12 1/2" x 10 3/4"	27.8 oz.
UZ903	067633		7/16" x 12 1/2" x 10 1/2"	11.5 oz.

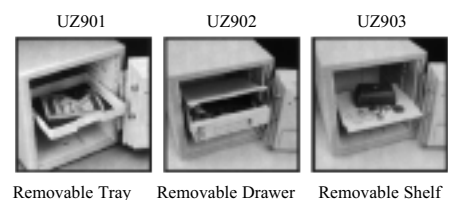

Removable Tray Removable Drawer Removable Shelf

Unican Series 1000 Heavy Duty Locksets

Ideal for limiting access to high traffic, security-sensitive areas. All-metal and UL listed for A label doors. Features 1/2" deadlocking latch which locks automatically when door is closed unless the optional passage feature is activated to allow free access at all times.

- Body: 7 3/8" x 3 1/8" x 3 13/16" • Latch Front: 1 1/8" x 2 1/4" • Backset: 2 3/4" • Door Thickness: 1 3/8" to 2 1/4" • Fits ASA 161 cut-outs

Mfg. #	Fin.	Function	EZ #
Standard Access Control (Combination Entry)			
SI1011 03 41	3	Push Button	064122
SI1011 05 41	5B	Push Button	013259
SI1011 26D 41	26D	Push Button	013258
SI203035	-	Service Kit	075500
Access Control With Double Pushbutton Control			
SIEE1011 26D41	26D	Double Pushbutton	064229

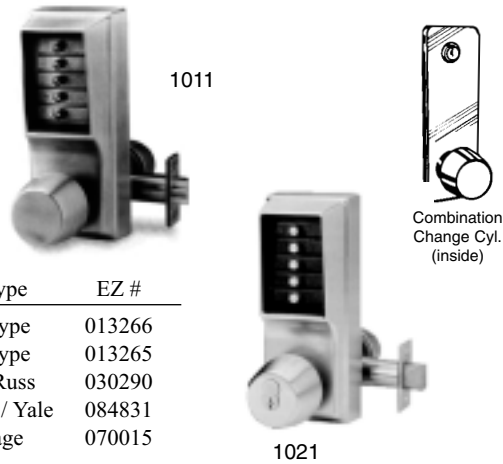

Access Control With Key Bypass (IC Cores not included)

Mfg. #	Fin.	Function	I/C Type	EZ #
SI1021B 05 41	5B	Push Button / Key Override	Best type	013266
SI1021B 26D 41	26D	Push Button / Key Override	Best type	013265
SI1021C 26D 41	26D	Push Button / Key Override	Corb/Russ	030290
SI1021M 26D 41	26D	Push Button / Key Override	Medeco / Yale	084831
SI1021S 26D 41	26D	Push Button / Key Override	Schlage	070015
Key Override Passage Mode				
SI1041B 26D 41	26D	Push Button / Key Bypass Passage	Best type	064125

L1000 Series Levers

- Designed for high frequency use, these handicapped accessible locksets are perfect for wherever limited access is required.
- Conforms to codes: complies with handicapped and fire codes in all applicable states and provinces.
- Easy installation: new inside trim plate adds to the ease of installation.
- One Hand Operation: Depress correct buttons in the proper sequence and push the lever downwards to retract the deadlocking latch.

Standard Lever Access Control

Mfg. #	Fin.	Hand	Function	EZ #
SILL1011 03 41	3	L/LHR	Push Button 1/2" Latch	064124
SILR1011 03 41	3	R/RHR	Push Button 1/2" Latch	064123
SILR1011 26D 41	26D	R/RHR	Push Button 1/2" Latch	013229
SILL1011 26D 41	26D	L/LHR	Push Button 1/2" Latch	013228
SILL1011 05 41	5B	L/LHR	Push Button 1/2" Latch	062465
SILR1011 05 41	5B	R/RHR	Push Button 1/2" Latch	062466
SI203038 000 01	-	L/LHR	Service Kit	075502
SI203037 000 01	-	R/RHR	Service Kit	075501

Replacement combination chamber
Mfg # SI74366 000 01 EZ # 013310



Lever Access Control With IC Type Key Bypass (IC Cores not included)

Mfg. #	Fin.	Hand	Key Override	EZ #
SILL1021B 05 41	5B	L/LHR	Best Type I/C	013236
SILR1021B 05 41	5B	R/RHR	Best Type I/C	062786
SILR1021B 026 41	26	R/RHR	Best Type I/C	068272
SILL1021B 026 41	26	L/LHR	Best Type I/C	068271
SILL1021B 26D 41	26D	L/LHR	Best Type I/C	013234
SILR1021B 26D 41	26D	R/RHR	Best Type I/C	013235
SILL1021C 26D 41	26D	L/LHR	Corbin / Russwin I/C	029405
SILR1021C 26D 41	26D	R/RHR	Corbin / Russwin I/C	029406
SILL1021M 26D 41	26D	L/LHR	Medeco / Yale I/C	064313
SILR1021M 26D 41	26D	R/RHR	Medeco / Yale I/C	064314
SILL1021R 26D 41	26D	L/LHR	Sargent I/C	029528
SILR1021R 26D 41	26D	R/RHR	Sargent I/C	064274
SILL1021S 26D 41	26D	L/LHR	Schlage I/C	013230
SILR1021S 26D 41	26D	R/RHR	Schlage I/C	013231

Passage Set Options

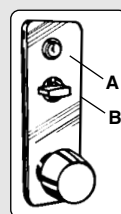

The key cylinder (A) shown is the standard control for changing combinations on the Unican Series 1000.

SPECIAL ORDER

The optional passage set (B) shown below the key cylinder, allows the lock to be opened without using the pushbutton combination. This is valuable when a door is to be left unlocked for extended periods. The optional passage set may be special ordered with a thumbturn activator, as shown, or with a key cylinder activator.



LP1000 Series Exit Device Controls

- Complies with ADA standards • Weather resistant; all-metal construction, ideal for use outdoors
- Exit device can have up to 60° rotation • Cast front housing with fixed lever and brass mounting plate.
- Includes a 2 3/4" long tailpiece to operate exit device from the outside • Designed for high-frequency use

Mfg. #	Fin.	Hand	Key Override	EZ #
SILLP1020B 26D 41	26D	L/LHR	Best Type I/C	013226
SILRP1020B 26D 41	26D	R/RHR	Best Type I/C	013227
SILLP1020S 26D 41	26D	L/LHR	Schlage I/C	067032
SILRP1020S 26D 41	26D	R/RHR	Schlage I/C	067028

R/RHR shown



2000-15 Access Control for Rim Exit Devices

Equipped with a 2 3/4" long adjustable connecting bar to operate surface mounted panic devices from the outside. It is designed to operate with devices that open with a maximum 90° clockwise rotation of the key cylinder, including many popular devices (consult the Simplex catalog or call one of our customer service reps for specific mfg/model applications).

Mfg. # SI2000 15 26D41 EZ # 013278



Series 3000 For Narrow Stile Lock

Operates with Adams Rite 4510 and 4710 latches. As a true Day/Night control, the 3000 integrates with existing key cylinder: as a key bypass for management, to lock out combination codes preventing all entry except by key and to activate the latch hold-back function removing all security from the door. Comes with lock housing and 1 of 4 drive assemblies (sold separately)

Mfg. #	Fin.	EZ #	Mfg. #	Hand	B.S.	EZ #
<i>Lock Housing</i>			<i>Drive Assemblies</i>			
SI3001 55 41	Duro	013293	SI3010 19 41	RH/RHRB	3/32"	013295
SI3001 26D41	26D	013294	SI3020 19 41	LH/LHRB	3/32"	013298
			SI3030 19 41	RH/RHRB	1 1/8"	013301
			SI3040 19 41	LH/LHRB	1 1/8"	013304



Series 8100 Mortise Lock

Heavy-duty, stand-alone pushbutton lock with three operation functions - lockout, combination and passage. Ideal for security-sensitive locations with high personnel turnover rate or high-frequency use locations. Accepts Best IC core.

Mfg # SIL8148B 26D41 EZ # 071107 (LH) Mfg # SIR8148B 26D41 EZ # 071108 (RH)

Mfg # SILR8148B 26D41 EZ # 071240 (LHR)



Series 3100 For Narrow Stile Lock

- Retrofits Adams Rite 4510/4710 mortise latch preparation • Exterior access is by combination. • Latch hold back
- Egress is free at all times • Complete lockset – no additional panic device hardware is required
- Mechanical Key Override for emergency or service entrance, accepts MS mortise cylinders

Mfg. #	Backset	EZ #	Mfg. #	Backset	EZ #
SI3112 26D41 RR	3/32"	075961	SI3132 55 41 RR	1 1/8"	075978
SI3112 55 41 RR	3/32"	075976	SI3132 26D41 RR	1 1/8"	073786
SI3122 55 41 LR	3/32"	075977	SI3142 55 41 LR	1 1/8"	075979
SI3122 26D41 LR	3/32"	075962	SI3142 26D41LR	1 1/8"	073787

55 = Duranodic (695)



4000 Series Pushbutton Lock

- Self contained using 4 AA alkaline batteries, no need for hardwiring • 3-hour UL fire rating
- All weather, heavy duty • Meets or exceeds ANSI/BHMA 156.2 Grade 1 compliance • Backset: 2 3/4"
- Replaces cylindrical or mortise locks • Finishes: 26D - Satin silver (ext) / Satin chrome (int)

Mfg. #	Fin.	Hand	Keyway	EZ #
SIL4153B 26D 41	26D	Left	Best	069316



7000 Series Auxiliary Locks

Compact, stylish and secure, the 7000 Series provides convenient auxiliary lock protection for residential and commercial applications. Mounts above existing lockset or can be used alone.

Mfg. #	Description	Finish	EZ #
SI7004 03 41	2 3/4" backset, auto relock, 1/2" deadlocking latch	"Chiara" Br. Brass	030160
SI7006 26D 41	2 3/8" backset, auto relock and latch holdback, 5/8" deadlocking latch	Satin Chrome	061844
SI7008 03 41	2 3/8" backset, manual relock, 1" tubular deadbolt	"Chiara" Br. Brass	061845
SI7014 03 41	Adjustable, 2 3/4" - 2 3/8" b.s. 1/2" deadlocking latch, auto relock	"Chiara" Br. Brass	070041
SI7004 26D 41	Adjustable, 2 3/4" - 2 3/8" b.s. 1/2" deadlocking latch, auto relock	Satin Chrome	030161

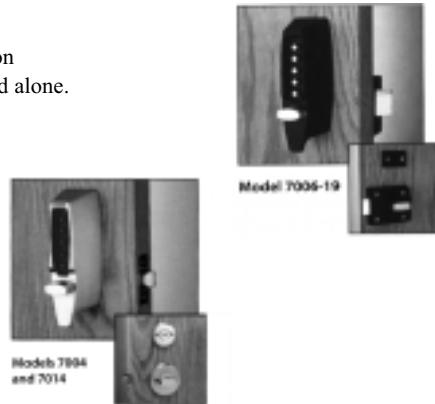

"Touch But'n" Medium Duty Door Locks/Access Control

- No keys to issue or control. • Thousands of possible combination options.
- Combination can be changed in just seconds. • Wear-tested for equivalent of 30 years intensive use.
- Completely mechanical – no electrical wiring. • Finishes: Satin Brass (4) & Brushed Chrome (26D)
- Easily installed in wood or metal doors • For right or left hand doors.

Mfg. #	Series	Fin.	Desc.	Door Thick.	EZ #
SI9020000 26D41	DL100	26D	Deadbolt	1 3/8" - 1 1/2"	013255
SI9040000 04 41	DL200	4	Deadbolt	1 3/4" - 2 1/8"	031055
SI9040000 26D41	DL200	26D	Deadbolt	1 3/4" - 2 1/8"	013272
<i>Key Bypass Model</i>					
SI9060000 26D41	DL-M100	26D	Deadbolt w/key override	1 3/8" - 1 1/2"	062467



Model NL Spring Latch Door Lock

Door locks automatically; opens with finger lever from inside. Thumb slide on inside holds retracted latch bolt in unlocked position. All latch type locks include deadlatching feature that prevents prying the latch back on closed door. Reversible latch bolt. 4"W x 5"H.

Mfg. #	Series	Fin.	Door Thick.	EZ #
SI9170000 26D41	NL100	26D	1 3/8" - 1 1/2"	013256
SI9190000 04 41	NL200	4	1 3/4" - 2 1/8"	013277
SI9190000 26D41	NL200	26D	1 3/4" - 2 1/8"	013276
<i>NL-M - Key Bypass Models</i>				
SI9380000 04 41	NL-M200	4	1 3/4" - 2 1/8"	013275
SI9380000 26D41	NL-M200	26D	1 3/4" - 2 1/8"	013274



E-Plex 5000 Series

- Combines mechanical pushbutton locks with added security of electronic access control • No wire through the door
- 100 access codes • Extensive audit trail • Programmable passage mode • ANSI/BHMA grade 1 • 3 year warranty

Mfg. #	Kwy	EZ #	Mfg. #	Kwy	EZ #
SIE5031B WL605 41	Best IC	084278	SIE5031XS WL605 41	SC1 KIL	084283
SIE5031B WL626 41	Best IC	084275	SIE5031XS WL626 41	SC1 KIL	084280
SIE5031B WL695	Best IC	084277	SIE5031XS WL695 41	SC1 KIL	084282
SIE5031S WL605 41	Schlage IC	084273	SIE5031R WL605 41	Sargent IC	084268
SIE5031X WL626 41	Schlage IC	084270	SIE5031R WL626 41	Sargent IC	084264
SIE5031S WL695 41	Schlage IC	084272	SIE5031R WL695 41	Sargent IC	084267

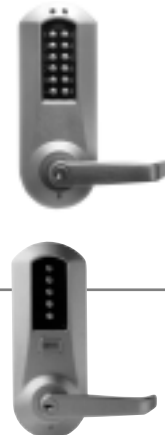

5000 Series Extra Heavy Duty Primary Lock

- Commercial Grade 1 Certification • Convenient Keyless Security • Key Override • Kaba 90 Keyway
- Non Handed, Can Be Changed In Seconds • Easy To Install: Fewer Parts, Better Fit. • 2-year Warranty

Mfg # SI 5021XK WL26D41 EZ # 076741



Accessories & Parts

Solitaire 850L Series - LearnLok

Stand-alone lock which enrolls users quickly and easily using specially designed function cards. All you have to do to begin enrolling users is swipe the learn card through the reader. Then, just swipe a user card and a user cancel card. If your requirements change and you need a more sophisticated system, LearnLok can be upgraded to full-featured Solitaire 850 or 950 Series systems. Every lock can enroll up to 200 users using LearnLok technology.

Certifications, Approvals and Testing:

- Meets UL 10B and ULC S-104, 20 minutes for wood doors and 3-hour fire rating for steel doors
- ADA-compliant lever • ANSI grade 1 A156.13

Dimensions:

- Door thickness adaptable from 1 3/8" to 2 1/2", 3/4" latch for ASM, 2 3/4" backset

Interchangeable Core:

- Ilco Unican • Best 6 pin or 7 pin (not supplied)

Power: 4 standard AA alkaline batteries last up to 80,000 openings or 4 years

Environmental Operating Conditions:

Weather resistant; withstands rain, dust and salt



Mfg#	Desc.	EZ #	Mfg#	Desc.	EZ #
IA8515021BLL2 626	Best IC kwy LH	071582	IA064 508674	Programing Module	071587
IA8515021BRL2 626	Best IC kwy RH	071583	IASP850L 2EM	Starter Pack	071584
IA135 509507 FCD	Audit Software	071586	IAUP850L 2	User Pack	071585

Also available in Medeco kwy

Starter Pack Includes: Quick reference guide, user log, function cards, user cards & user cancel cards

User Pack Includes: 25 user cards

Accessories and Replacement Parts

For metal door frame installations. Contains surface mounted strike and adjustable shim (3/8" or 1/4") or riser plate to align inside housing to special strike. Standard lock includes both a sheet metal strike for outswing doors and cast box strike for inswing wood frame installation.

Mfg. #	Description	Fin.	EZ #
SI800 04 41	Adapter Kit for 900 Series	4	013224
SI800 26D41	Adapter Kit for 900 Series	26D	013223



Riser plate for 900 series Mfg # SI74468CH EZ # 013241	Inside lever coil return spring for L1000/8100 Mfg # SI201732 000 01LH EZ # 013290	Cylindrical drive unit assembly for 1000 Mfg # SI204202 26D01 EZ # 037178
Surface-mounted cast strike for 900 series Mfg # SI74464 26D EZ # 013269	Fixed sleeve for L1000/8100 Mfg # SI201733 26D01LH EZ # 064128	7004 latch assembly 2 3/4" backset Mfg # SI202003 03 41 EZ # 037233
Surface-mounted cast strike for 900 series Mfg # SI74464 4 EZ # 013270	Fixed sleeve for L1000/8100 Mfg # SI201727 26D01RH EZ # 064127	Mfg # SI202003 26D 41 EZ # 067227
Clutch sub-assembly for 1000 series Mfg # SI201430 000 01 EZ # 013285	Clutch cover assembly for L1000/8100 Mfg # SI201780 000 01RH EZ # 064130	Trim plate cover 2 1/8" bores for 7000 Mfg # SI24380 03 01 EZ # 060862
Replacement latch for 1000/L1000 series Mfg # SI201144 26D01 EZ # 013283	Clutch cover assembly for L1000/8100 Mfg # SI201781 000 01LH EZ # 064131	Combo chamber for 1000/L1000/3000/8100 Mfg # SI74366 000 01 EZ # 013310
Knob return spring for 1000 series Mfg # SI201019 000 01 EZ # 013281	Clutch assembly (RH) for L1000 Mfg # SI201788 000 01 EZ # 060480	Combo chamber for 2015 Mfg # SI74241 EZ # 061872
Installation Wrench for 1000/L100/8100 Mfg # SI201278 018 01 EZ # 037187	Clutch assembly (LH) for L1000 Mfg # SI201789 000 01 EZ # 046318	Combo chamber for 900 series Mfg # SI74080 000 01 EZ # 013240
Outside lever ext return spring for L1000/8100 Mfg # SI201762 000 01 EZ # 013291	ASA roller strike for 1000/L1000 Mfg # SI201821 26D41 EZ # 064126	
Inside lever coil return spring for L1000/8100 Mfg # SI201730 000 01RH EZ # 064129	Anti-spy shield for 1000/L1000 Mfg # SI201600 19 41 EZ # 037156	combo chamber for 900 series





Accessories & Parts

Solitaire 850L Series - LearnLok

Stand-alone lock which enrolls users quickly and easily using specially designed function cards. All you have to do to begin enrolling users is swipe the learn card through the reader. Then, just swipe a user card and a user cancel card. If your requirements change and you need a more sophisticated system, LearnLok can be upgraded to full-featured Solitaire 850 or 950 Series systems. Every lock can enroll up to 200 users using LearnLok technology.

Certifications, Approvals and Testing:

- Meets UL 10B and ULC S-104, 20 minutes for wood doors and 3-hour fire rating for steel doors
- ADA-compliant lever • ANSI grade 1 A156.13

Dimensions:

- Door thickness adaptable from 1 3/8" to 2 1/2", 3/4" latch for ASM, 2 3/4" backset

Interchangeable Core:

- Ilco Unican • Best 6 pin or 7 pin (not supplied)

Power: 4 standard AA alkaline batteries last up to 80,000 openings or 4 years

Environmental Operating Conditions:

Weather resistant; withstands rain, dust and salt



Mfg#	Desc.	EZ #	Mfg#	Desc.	EZ #
IA8515021BLL2 626	Best IC kwy LH	071582	IA064 508674	Programing Module	071587
IA8515021BRL2 626	Best IC kwy RH	071583	IASP850L 2EM	Starter Pack	071584
IA135 509507 FCD	Audit Software	071586	IAUP850L 2	User Pack	071585

Also available in Medeco kwy

Starter Pack Includes: Quick reference guide, user log, function cards, user cards & user cancel cards

User Pack Includes: 25 user cards

Accessories and Replacement Parts

For metal door frame installations. Contains surface mounted strike and adjustable shim (3/8" or 1/4") or riser plate to align inside housing to special strike. Standard lock includes both a sheet metal strike for outswing doors and cast box strike for inswing wood frame installation.



Mfg. #	Description	Fin.	EZ #
SI800 04 41	Adapter Kit for 900 Series	4	013224
SI800 26D41	Adapter Kit for 900 Series	26D	013223

Riser plate for 900 series Mfg # SI74468CH EZ # 013241	Fixed sleeve for L1000/8100 Mfg # SI201733 26D01LH EZ # 064128	Cylindrical drive unit assembly for 1000 Mfg # SI204202 26D01 EZ # 037178
Surface-mounted cast strike for 900 series Mfg # SI74464 26D EZ # 013269	Fixed sleeve for L1000/8100 Mfg # SI201727 26D01RH EZ # 064127	7004 latch assembly 2 3/4" backset Mfg # SI202003 03 41 EZ # 037233 Mfg # SI202003 26D 41 EZ # 067227
Surface-mounted cast strike for 900 series Mfg # SI74464 4 EZ # 013270	Clutch cover assembly for L1000/8100 Mfg # SI201780 000 01RH EZ # 064130	Trim plate cover 2 1/8" bores for 7000 Mfg # SI24380 03 01 EZ # 060862
Clutch sub-assembly for 1000 series Mfg # SI201430 000 01 EZ # 013285	Clutch cover assembly for L1000/8100 Mfg # SI201781 000 01LH EZ # 064131	Combo chamber for 1000/L1000/3000/8100 Mfg # SI74366 000 01 EZ # 013310
Replacement latch for 1000/L1000 series Mfg # SI201144 26D01 EZ # 013283	Clutch assembly (RH) for L1000 Mfg # SI201788 000 01 EZ # 060480	Combo chamber for 2015 Mfg # SI74241 EZ # 061872
Knob return spring for 1000 series Mfg # SI201019 000 01 EZ # 013281	Clutch assembly (LH) for L1000 Mfg # SI201789 000 01 EZ # 046318	Combo chamber for 900 series Mfg # SI74080 000 01 EZ # 013240
Installation Wrench for 1000/L100/8100 Mfg # SI201278 018 01 EZ # 037187	ASA roller strike for 1000/L1000 Mfg # SI201821 26D41 EZ # 064126	Combo chamber for 5000 series Mfg # SI74832 00 01 EZ # 084228
Outside lever ext return spring for L1000/8100 Mfg # SI201762 000 01 EZ # 013291	Anti-spy shield for 1000/L1000 Mfg # SI201600 19 41 EZ # 037156	
Inside lever coil return spring for L1000/8100 Mfg # SI201730 000 01RH EZ # 064129	Service Kit for 1000 LH Mfg # SI203038 000 01 EZ # 075502	
Inside lever coil return spring for L1000/8100 Mfg # SI201732 000 01LH EZ # 013290		combo chamber for 900 series



AMC/Jeep/Eagle

91/92 Jeep Comanche, Cherokee, & Wrangler. Uncoded

Mfg # BR701245 EZ # 002220

93-95 Wrangler. Saginaw Tilt, Coded

Mfg # BR702007 EZ # 073379

Door Locks

Most Models AMC/Jeep/Eagle 1988 - 90
Uncoded.

Mfg # BR605965 EZ# 002096

Tailgate Lock

Fits AMC tailgates (Also see Door lock 605965)

Mfg # BR608695 EZ# 026172



Caps and Shutters

Packed 10 per box

Mfg # BR320318 Chrome EZ # 001839

Mfg # BR321167 Black EZ # 026167

Mfg # BR320376 Chrome EZ # 001841

Mfg # BR321848 Black EZ # 001936

Mfg # BR59995 Chrome EZ # 002090

Mfg # BR594391 Black EZ # 028623



Chrysler

Ignitions

Standard Column: 1974-1990

Mfg # BR700141 Coded w/molded keys EZ # 002150

Mfg # BR593448 Uncoded EZ # 002020

Mfg # BR701249 Coded EZ # 002224

With Tilt Column:

Mfg # BR700142 Uncoded, chrome EZ # 002151

Mfg # BR700510 chrome EZ # 002164

Double Bitted: 1990-1991

Mfg # BR701245 Uncoded - tilt column, black EZ # 002220

Mfg # BR701246 Uncoded - push to lock EZ # 002221

Mfg # BR701247 Uncoded - push to lock EZ # 002222

Mfg # BR701248 Uncoded - standard, black EZ # 002223

Mfg # BR701757 Uncoded - push to lock EZ # 062031

Mfg # BR703502 Service kit EZ # 070434

Mfg # BR701924 Coded EZ # 073377

Mfg # BR705096 Coded EZ # 073378

Double Bitted: 1993

Mfg # BR701941 Saginaw Service Kit EZ # 044341

Mfg # BR702126 Accustar Service Kit EZ # 051275

Double Bitted: 1994

Mfg # BR702417 Saginaw Service Kit EZ # 070431

Double Bitted: 1994-1997

Mfg # BR702418 Modular L/H Body Service Kit EZ # 068943

Mfg # BR702419 Saginaw Service Kit EZ # 070432

Mfg # BR702420 Modular P/L Body Service Kit EZ # 069881

Double Bitted: 1995-96

Mfg # BR702788 Accustar Service Kit EZ # 061470

Double Bitted: 1998-2000

Mfg # BR703719 Flag style driver w/sidebar EZ # 066609

Mfg # BR703718 Modular L/H body w/sidebar EZ # 066608

Service Package:

Mfg # BR702671 EZ # 070435

Door Locks

Most Models 1968-1990

Mfg # BR608429 Uncoded-chrome EZ # 002120

Mfg # BR700105 Uncoded-black EZ # 002143

Most Models 1990-91 Double Bitted

Mfg # BR701233 Uncoded-snap cap EZ # 002208

Most Models 1993-94 Double Bitted

Mfg # BR702127 Uncoded-dual EZ # 044337

Mfg # BR702143 Uncoded-black/dual EZ # 044326

Most Models 1989-92

Mfg # BR701714 Service Package EZ # 044309

Most Models 1997-00

Mfg # BR703327 Service Package EZ # 077254

Deck/Tailgate Locks

Most Models 1973-89

Mfg # BR702421 Service kit (94-95) EZ # 069429

Ram Charger

Mfg # BR608695 Uncoded EZ # 026172

Double Bitted 1990-91

Mfg # BR701781 Uncoded, w/lever-blk EZ # 040222

Mfg # BR701238 Uncoded, w/lever-blk EZ # 040223





Automotive Parts • Key Blanks

Chrysler (Cont'd.)

Caps and Shutters

Mfg # BR322824	Door Case cap	EZ # 076549
Mfg # BR322825	Case Cap	EZ # 076550
Mfg # BR46766	Shutter spring	EZ # 001984
Mfg # BR46994	Tumbler spring	EZ # 060168
Mfg # BR322374	Chrome cap	EZ # 001902
Mfg # BR321576	Black Cap	EZ # 040216
Mfg # BR321847	Chrome cap	EZ # 030141
Mfg # BR321848	Black cap	EZ # 001936
Mfg # BR321709	Chrome cap	EZ # 001917
Mfg # BR321710	Black cap	EZ # 001918
Mfg # BR594391	Black shutter	EZ # 028623
Mfg # BR594753	Chrome shutter	EZ # 002055



Tumblers For Glove Box

Mfg # BR321761	#1	EZ # 001920
Mfg # BR321762	#2	EZ # 001921
Mfg # BR321763	#3	EZ # 001922
Mfg # BR321764	#4	EZ # 001923
Mfg # BR46890	Springs	EZ # 001988
Mfg # BR56115	Springs	EZ # 073279



Saturn

Mfg. #	Description	EZ #
BR321761	#1 Tumbler	001920
BR321762	#2 Tumbler	001921
BR321763	#3 Tumbler	001922
BR321764	#4 Tumbler	001923
BR46890	Tumbler springs	001988
BR46772	Tumbler springs	001985
BR321480	Univ. Door Clip	001896



Tumbler



Spring

VATS Key Blanks

Single Sided

Mfg. #	EZ#
BR595511	002032
BR595512	002033
BR595513	002034
BR595514	002035
BR595515	002036
BR595516	002037
BR595517	002038
BR595518	002039
BR595519	002040
BR595520	002041
BR595521	002042
BR595522	002043
BR595523	002044
BR595524	002045
BR595525	002046

VATS Key Blanks

Double Sided

Mfg. #	EZ#
BR596772	002072
BR596773	002073
BR596774	002074
BR596775	002075
BR596776	002076
BR596777	002077
BR596778	002078
BR596779	002079
BR596780	002080
BR596781	002081
BR596782	002082
BR596783	002083
BR596784	002084
BR596785	002085

Ford

Ignitions

<u>1977 - present, coded</u>	
Mfg # BR609485	EZ # 002130
<u>1996 - present Sable/Taurus</u>	
Mfg # BR707624	EZ # 061240



Deck Locks

<u>T-Bird, Cougar, Lincoln 1996</u>	
Mfg # BR703250	EZ # 071141



Door Locks

Explorer F-150 & Bronco (old) Med. Duty Ranger

Mfg # BR703369	EZ # 061239
----------------	-------------



1966 - 1980, uncoded

Mfg # BR608433	EZ # 002122
----------------	-------------

1981 - current, uncoded

Mfg # BR608843	EZ # 002127
----------------	-------------



Glove Box Locks

Double Bitted, 5 cut

Mfg # BR607843	EZ # 002102
----------------	-------------



Caps, Shutters & Springs

Mfg # BR322257	Ford Chrome cap	EZ # 038458
Mfg # BR322534	Quest Black cap	EZ # 061446
Mfg # BR322535	Quest Chrome cap	EZ # 061437
Mfg # BR322672	Taurus/Sable black cap	EZ # 061438
Mfg # BR46969	Ford Door tumbler spring	EZ # 061247
Mfg # BR596656	Taurus/Sable/Quest shutter	EZ # 061271
Mfg # BR46970	Sable/Taurus ign. spring	EZ # 061248

Tumblers

Mfg # BR322261	Door Tumbler #1 100 pk	EZ # 071776
Mfg # BR322262	Door Tumbler #2 100 pk	EZ # 061260
Mfg # BR322263	Door Tumbler #3 100 pk	EZ # 061261
Mfg # BR322264	Door Tumbler #4 100 pk	EZ # 061262
Mfg # BR322265	Door Tumbler #5 100 pk	EZ # 061263

Key Blanks

Mfg. #	Desc.	EZ #
BR320588	GM "A" Prim	001856
BR320589	GM "B" Sec	001857
BR320652	GM "C" Prim	001859
BR320653	GM "D" Sec	001860
BR320404	GM "E" Prim	001843
BR320405	GM "H" Sec	001844
BR320470	GM "J" Prim	001848
BR320471	GM "K" Sec	001849
BR322710	GM, Key #2	069009
BR595312	GM, Key #56	002059
BR597749	GM, Key #75 Molded	061473
BR597791	GM, Key #75 Truck	063815
BR598007	Chevy, Key #75 Truck	071905
BR598033	GM, Key #88 Olds	066209
BR598333	Taurus / Sable trans	062682
BR599114	Taurus trans	072983
BR692574	Ford cloneable trans	085276





Automotive Locks: General Motors

Ford • Adapters • Probe • Kits

Key Blanks (cont.)

Mfg. #	Desc.	EZ #	Mfg. #	Desc.	EZ #	Mfg. #	Desc.	EZ #
BR599179	Mercury Sable trans	072839	<i>Heavy Trucks</i>			<i>Double Bitted Key Blank</i>		
BR599487	03 Saturn key #93	079069	BR320734	Kenworth, #3	070903	BR594145	Chrysler	002029
BR690648	Mits Trans #90	078597	BR320774	Peterbilt, #3	070904	<i>Industrial Key Blank</i>		
BR691259	Linc Trans PAT III	080746	BR323688	Mack, #2	068951	BR322861	-	073654
BR692020	Mits Trans	083612	BR322727	Mack, #14	065572			

Vats Double Sided Adapter

Mfg # BR597263
EZ # 025632



Vats Key Adapter

Mfg # BR595872
EZ # 002065

Vats Work Key

Mfg # BR321631
EZ # 001910



Vats Probe

Mfg # BR704500
EZ # 040224



Vats Ignition Sector

Mfg # BR701285 EZ # 002199



Vats Ignition C-Body





Mfg # BR701286 EZ # 002225

Double Sided Vats Ignition

Mfg # BR702563
EZ # 060393



GM & Ford Ignition Locks

1969-79 GM Mfg # BR607893 EZ # 002106	Beretta/Corsica Pushbutton Mfg # BR701404 EZ # 002153	Modular, pushbutton Mfg # BR702926 EZ # 060394	Taurus/Sable 1996 - current Mfg # BR707624 EZ # 061240
Standard VATS Auto trans. 86 - current Mfg # BR700754 EZ # 002190	Allante W-body 1988-Current Mfg # BR701406 EZ # 002171	Dbl Bitted, Uncombined Modular, Pushbutton Mfg # BR702927 EZ # 060395	
Pushbutton VATS Man trans. 86 - current Mfg # BR700938 EZ # 002200	Lumina, Grand Prix, Cutlass, Regal (89-94) Mfg # BR701407 EZ # 073381	Taurus/Sable (96- current) LSP Lock Service Kit Mfg # BR703162 EZ # 061273	
Sector gear. 89 - 92 Cadillac, Allante, Seville, Eldorado Mfg # BR701285 EZ # 002199	Beretta/Corsica 1987-90 Pushbutton Mfg # BR701408 EZ # 040220	GM Ignition LSP Passlock Service Kit Mfg # BR703602 EZ # 071782	
1979-Current GM Chrome Mfg # BR701398 EZ # 002132	Modular, coded Mfg # BR701869 EZ # 060190	GM Ignition Lock VATS CSS column double-bitted Mfg # BR703605 EZ # 077253	
1979-Current GM Black Plastic Mfg # BR701400 EZ # 002173	Double Bitted Modular, Pushbutton Mfg # BR701870 EZ # 060392	GM Ignition Passlock Service Kit Mfg # BR703935 EZ # 066611	

Door Locks Service Packages

Application: Short Cyl Length - 7/32", Fits most GM Mfg # BR607868 EZ # 002104	Single Bitted - Long Style Chrome. Mfg # BR607870 EZ # 002105	
Application: 84 - Current Mini-Van and 90 - Current U-Van. Front Door. Mfg # BR700842 EZ # 028626	Chrysler Mini Van Service Package Mfg # BR702784 EZ # 071780	700842
	Double Bitted - Chrysler Snap Cap Cargo Rear Door Mfg # BR702785 EZ # 038499	Double Bitted - GM Lock Service Package Mfg # BR703236 EZ # 061478

Automotive Kits

GM Pin / Service Kit Mfg # BR702767 EZ # 051276	Ford 8 Cut Keying Kit Mfg # BR703373 EZ # 061443	GM Glove Tumbler Kit Mfg # BR609862 EZ # 002141
	Chry Sgl Bitted Serv Kit Mfg # BR608798 EZ # 044256	Chry Dbl Bitted Serv Kit Mfg # BR703927 EZ # 066211



Deck/Tailgate & Glove Box Locks

Application: Standard, for use with vertical clip, Service Pkg
 Mfg # BR700182 EZ # 002155

Application: Firebird 82-85, Fiero 84-89, Beretta/Corsica 87 - Current
 Mfg # BR700508 EZ # 002163

Application: Standard, Service Pkg
 Mfg # BR608317 EZ # 002116

Glove Box Lock, GM Single Bitted
 Mfg # BR608167 EZ # 002109



Parts

Mfg. #	Desc.	EZ #
BR592643	GM Deck Plug	002013
BR47522	Door Gasket	001992
BR47544	Trunk Gasket	001993
BR46399	Deck/Tailgate Return Spring	001973
BR46986	10 Cut Ign. Return Spring	061418
BR46934	Tumbler Spring	061424
BR381067	Ford Rod Retainer	076548
BR381282	Ford Rod Retainer LH	076545
BR381283	Ford Rod Retainer RH	076546
BR609782	Wing - Lock (chrome)	002138
BR700845	Wing - Lock (black)	040219
BR321936	GM Pawl Retainer	001903
BR321089	GM Rod Retainer	001882
BR381378	GM Rod Retainer	076547
BR380256	GM Rod Retainer RH	001959
BR380257	GM Rod Retainer LH	001960
BR591301	GM Door Plug	002006
BR320714	GM Deck Shaft	044128

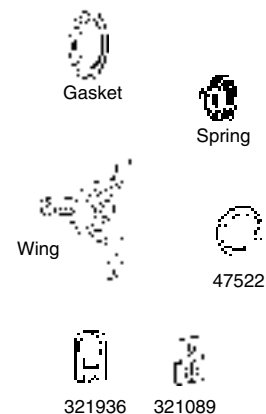

Mfg. #	Desc.	EZ #
BR321370	GM Shaft	069430
BR380239	GM Fastener	040217
BR380904	GM GB Plug	069431

Caps and Shutters

Mfg. #	Desc.	EZ #	Mfg. #	Desc.	EZ #
BR320395	Standard Cap	001842	BR322340	Snap Cap Lanced (chrome)	061419
BR320969	Optic Cap	001875	BR322355	Stove Top Cap (black)	061420
BR59885	Door/Deck Shutter	002088	BR322661	S/T TG Manual (black trico)	060172
BR597819	Door/Deck - Black Shutter	002025	BR322658	Standard Cap (black)	061455
BR599466	Chevy/GM shutter	076552	BR47603	Snap Cap (black) Scalp Only	044092
BR321788	GM Case Cap (chrome)	029389	BR593555	Shutter	061417
			BR599466	Lanced (chrome) (not shown)	061421



Single Bitted - Sidebar (GM Ignition, Doors, Deck & Tailgates)

Mfg. #	Desc.	EZ #
BR322051	#1	001834
BR322052	#2	001835
BR322053	#3	001836
BR322054	#4	001837
BR322055	#5	001838
BR46648	Spring	001977
BR321127	Retainer	001886
BR46650	Spring	001978

Double Bitted (GM Ignition)

Mfg. #	Desc.	EZ #
BR323121	#1	070813
BR323122	#2	070814
BR323123	#3	070815
BR323124	#4	070816
BR56028	Spring	061450

Double Bitted (GM Doors, Rear Doors & Tailgates)

Mfg. #	Desc.	EZ #
BR322241	#1	061415
BR322242	#2	061423
BR322243	#3	061422
BR322244	#4	061312
BR311496	Plug Retainer	061425
BR322161	Retainer Tumbler	061416

Double / Single Bitted Wafers (Chrysler Glove Compartment)

Mfg. #	Desc.	EZ #
BR322521	#1	061426
BR322522	#2	061427
BR322523	#3	061428
BR322524	#4	061429
BR323230	Retainer	061430

Double Bitted Wafers (Chrysler Ignition)

Mfg. #	Desc.	EZ #
BR322691	#1	066596
BR322692	#2	066597
BR322693	#3	066598
BR322694	#4	066599

Double Bitted Wafers (Chrysler Door)

Mfg. #	Desc.	EZ #
BR322361	#1	061451
BR322362	#2	061452
BR322363	#3	061453
BR322364	#4	061454

C3 Aiset Portable

- Rubber bumper • 17,000 combinations
- User resettable • Hardened shackle

Can be mounted on door knobs, faucets, fences and can be easily moved from place to place. Ideal for spare key storage on home, delivery boxes, boat, workshop or shed.



Mfg # SRC3VP EZ # 027876

C3 Pushbutton Portable

- User changeable pushbutton combo
- Titanium colored • All purpose portable KeyBox

Designed for easy use by the pushbutton, changeable combination. The black DoorGuard rubber bumper protects against occasional nicks & scratches making this lock virtually indestructible.



Mfg # SR001192STOR A KEY EZ # 063502

M5 Mortise KeyBox

- Accepts 1 1/8" or 1 1/4" mortise cylinders
- Surface mount unit
- Locknut and spacer ring provided



Mfg # SRM5 EZ # 013362

S5 Aiset

- Surface mount • 17,000 combinations
- User resettable • Die cast Zamac

Comes with four screws for mounting on a variety of surfaces. Can be mounted on vacation homes, outbuildings, worksites, as well as homes for easy access for friends and families. Holds 8-10 conventional keys.



Mfg # SRS5VP EZ # 027877

S6 Pushbutton

- Attaches securely and permanently to almost any wall or flat surface with the screws provided
- Stylish, streamlined key box
- Holds two house keys
- Optional protective cover
- All metal, powder painted lid



Mfg #	Desc.	EZ #
SR001193STOR A KEY	Titanium	063503
SRS6 WHITE	White	070259
SRS6 CLAY	Clay	070260
SRS6COVER	Cover	075556

S7 Big Box

- Access card fits easily into larger storage area
- Accommodates multiple keys and larger keys
- Durable, recessed lid for tamper-resistant design.
- Pushbutton changeable combination
- Great for shops, trailers or RV's



Mfg # SRS7 EZ # 066440

Auto Suv

- Permanent auto mount, pushbutton
- Perfect for cars, trucks, motor cycles, SUVs, boats, tool boxes, trailers and RVs.
- Durable protective cover keeps out dirt and grime
- Interlocking faceplate prevents tampering and unauthorized access



Mfg # SR001312SUV EZ # 070805

Key Cabinets

Featuring 16-gauge steel construction and a continuous piano hinge. Keys hang directly on steel key hooks or on supplied numbered key tags. Keyless QuickAccess pushbutton lock option gives added security and convenience. Unique clutch mechanism protects against forced entry. Change the entry code as often as you like with more than 1,000 possible combinations.

Mfg #	Desc.	EZ #
-------	-------	------

Pushbutton Cabinet

SR1795	30 Key Cabinet	083345
SR1796	60 Key Cabinet	083346
SR1797	120 Key Cabinet	083347

Keyed Cabinet

SR1801	30 Key Cabinet	083349
SR1802	60 Key Cabinet	083350
SR1803	120 Key Cabinet	083551

Quick Access Lock Only

SR1798	Clay Color	083348
SR1773	Titanium Color	083592





Miscellaneous Parts

001

- For wood or metal jambs • Faceplate 1 1/4" wide
- Use with locksets having up to 1/2" throw
- Solid Cast Latch, cavity - 1 3/8" x 9/16" x 1/2"
- Mortise Type – backset 1 9/16" deep
- Fail-Secure – unlocks when energized



Mfg. #	Fin.	Voltage	EZ #
TR001	US4	4-6VDC/8-16VAC	013683
TR001C	26D	4-6VDC/8-16VAC	013685

005/S005

- For wood jambs and iron gates
- Use with bored cylindrical locksets having up to 1/2" throw; S005 5/8" throw.
- 005 Latch cavity - 1/2" D x 9/16" W x 1 5/8" H
- S005 Latch cavity - 5/8" D x 23/32" W x 1 9/16" H
- Mortise Type – backset 2 3/4" deep; S005 2 7/8" deep
- Fail-Secure – unlocks when energized • Corrosion Resistant



Mfg. #	Fin.	Voltage	EZ #
TR005	4	4-6VDC/8-16VAC	013693
TR005C	26D	4-6VDC/8-16VAC	013694
TRS005 4	4	4-6VDC/8-16VAC	042195
TRS005C24VAC	26D	24VAC	027612

003

- Use with locksets or night latches having up to 1/2" throw
- For wood or metal jambs and in-swinging applications.
- Narrow Stile - Surface mount - 1 1/4" wide
- Solid Cast Latch: cavity - 1/2" D x 9/16" W x 1 3/8" H
- Fail-Secure – unlocks when energized
- Heavy-Duty latch springs • Corrosion resistant



Mfg. #	Fin.	Voltage	EZ #
TR003	Blk	4-6VDC/8-16VAC	027611

Transformers

Mfg. #	Volts	Wats	AMPS	EZ #
<i>Clamp-On Type</i>	8	10	1.25	
TR125	16	10	.62	013708
	24	20	.83	
<i>Plug-In Type</i>				
TR5204	12VAC	10	.83	027619



Accessories

Silver Push Button
Mfg # TR71A EZ # 042199



5/8" Silver Push Button
Mfg # TR45A EZ # 042198



Door Buzzer
• 3-6 VDC / 8-16 VAC • 92 DB at 3 feet
• Current Draw Max. 1 AMP
Mfg # TR270 EZ # 042197



004

- For wood jambs • Corrosion Resistant
- Use with locksets (up to 1/2" throw) with individual dead bolts
- Knockouts Top and Bottom – 1 11/16" x 9/16"
- Solid Cast Latch: cavity - 1/2" D x 1/2" W x 1 9/16" H
- Mortise Type – backset 2 11/16" deep
- Fail-Secure – unlocks when energized



Mfg. # TR004 Voltage 4-6VDC/8-16VAC EZ # 013692

002

- For wood or metal jambs • Corrosion Resistant
- Use with locksets having up to 1/2" throw.
- 1 7/16" wide faceplate
- Auxiliary Lever Ramps 2 7/8"; For locksets with auxiliary dead locking levers
- Solid Cast Latch: cavity - 1/2" D x 9/16" W x 1 3/8" H
- Mortise Type: backset 1 9/16" deep
- Fail-Secure – unlocks when energized



Mfg. # TR002 Voltage 4-6VDC/8-16VAC EZ # 013688

006

- For metal or wood jambs for in-swinging applications.
- Solid Cast Latch: cavity - 1/2" D x 1/2" W x 1 3/8" H
- Use with locksets or night latches having up to 1/2" throw.
- Corrosion Resistant • Fail-Secure – unlocks when energized



Mfg. # TR006 Voltage 4-6VDC/8-16VAC EZ # 013695

EN800

- For wood or metal single door frames.
- Use with surface mounted rim exit device with up to 1" throw
- 2000 lbs holding force
- All stainless steel construction • Fail Secure



Mfg. # TREN80012VDC EZ # 075965

3234 Mini Strike

- For metal door frames. (W= wood frame)
- Use with locksets having up to 5/8" throw.
- All stainless steel locking parts
- Fail Secure • Faceplate 2 3/4" x 1 1/8"



Mfg. # TR3234 12D 26D EZ # 074387

Mfg. # TR3234W LC 26D EZ # 082764 (w/line conditioner)

3478 Axion Series

- For wood or metal door frames.
- Use with locksets having up to 5/8" throw.
- Meets ANSI - A115.1 standard
- Fail Secure • Faceplate 4 7/8" x 1 1/4"



Mfg. # TR3478 12VDC 32D EZ # 076582

Electric Strike Guards

Slimline electric strike guards fits most Rutherford, HES Adams Rite & Rofu electric strikes (lever sets & key knobs).

Mfg. #	Fin.	EZ #
UVESGLK BC	Brushed chrome	081839
UVESGLK DU	Duranodic	081840
UVESGLK PC	Polished chrome	081841

Fits Rutherford ONLY

UVRESGLK BC	Brushed chrome	081842
UVRESGLK DU	Duranodic	081843
UVRESGLK PC	Polished chrome	081844

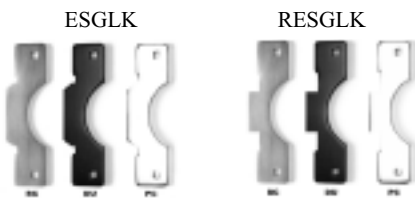

Conversion Plates

Converts mortise prep to cylindrical prep.

Mfg. #	Fin.	EZ #
UVCP86161BC	Brushed chrome	081845
UVCP86161DU	Duranodic	081846
UVCP86161PC	Polished chrome	081847
UVCP86161PRCT	Prime Coat	081848



Mortise Filler Plates

1 1/4" x 8" for mortise latch prep.

Mfg. #	Fin.	EZ #
UVFP1148BC	Brushed chrome	081849
UVFP1148DU	Duranodic	081850
UVFP1148PC	Polished chrome	081851
UVFP1148PRCT	Prime Coat	081852



ASA Cylindrical Lock Filler Plates

1 1/4" x 4 7/8" for cylindrical lock ASA latch prep

Mfg. #	Fin.	EZ #
UVFP114478BC	Brushed chrome	081853
UVFP114478DU	Duranodic	081854
UVFP114478PC	Polished chrome	081855
UVFP114478PRCT	Prime Coat	081856

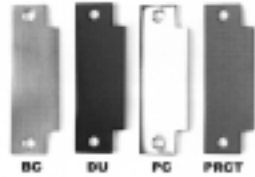

Cylindrical Lock Filler Plates

1 1/8" x 2 1/4" for cylindrical lock latch prep

Mfg. #	Fin.	EZ #
UVFP118214BC	Brushed chrome	081857
UVFP118214DU	Duranodic	081858
UVFP118214PC	Polished chrome	081859
UVFP118214PRCT	Prime Coat	081860



Hole Covers

Fits up to a 2 1/8" hole

Mfg. #	Fin.	EZ #
UVHC258BC	Brushed chrome	081861
UVHC258DU	Duranodic	081862
UVHC258PC	Polished chrome	081863
UVHC258PRCT	Prime Coat	081864

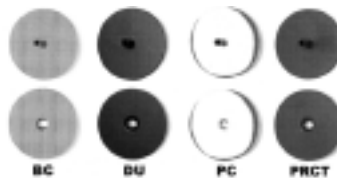

Heavy Duty Strike Plate

- Two post reinforcement
- Mill finish • Screws included
- Combine with deadbolt for protection against forced entry

Mfg # UVTUFF STRIKE EZ # 078379





Guard-X

22 SERIES

- For single and double doors with mullion
- UL listed for accident hazard installations
- Covers stock hollow metal doors with 161 cutouts.
- Exclusive sound dampening features • Non handed
- Field sizeable • Hex key dogging on non fire rated exits • Length: 36" (for door sizes 2'6" - 3'0")
- 3/4" throw deadlocking latch bolt on 22 series - 1/2" throw deadlocking latch bolt on 2227 Series

210NL
Key
retracts
latchbolt



230L
Key
unlocks
lever



Mfg. #	Fin.	Description	EZ #
VD22EOX28	28	Exit only	013741
VD22EOX313	313	Exit only	013743
VD22EO FSP28	28	Fire rated Exit only	066362
VD22EO FSP313	313	Fire rated Exit only	066363

Surface Mounted Vertical Rod

VD2227EOX28	28	Exit only	065896
VD2227EOX313	313	Exit only	065888

Exterior Trim Only

VD210K SP28	28	Knob	027622
VD210NL 28	28	Pull Trim	013737
VD210NLX313	313	Pull Trim	013738
VD230LX28	28	Lever	065889
VD230LX313	313	Lever	065890
VD22ALK SP28	28	Alarm Kit	013739



Devices are stocked for 3'0" door: 28 - Satin Aluminum 313 - Anodized Duranodic

88 SERIES

- Traditional crossbar design with proven service on rugged applications
- For all types of flush & wide stile doors
- UL listed for accident hazard installations
- Covers 86 or 161 stock hollow metal cutouts.

Mfg. #	Fin.	Description	EZ #
VD88EO26D	26D	Exit only	013767

Surface Mounted Vertical Rod

VD8827EO26D	26D	Exit only	042227
-------------	-----	-----------	--------

Exterior Trim Only

VD880NL R26D	26D	Night latch **	027628
VD880TP R26D	26D	Thumb piece	037250

88CK-TP Converts "EO" device to "TP" Device

VD88CK TP26D	26D	Converter	042224
--------------	-----	-----------	--------

** 88 series only Devices are stocked for 3'0" door.

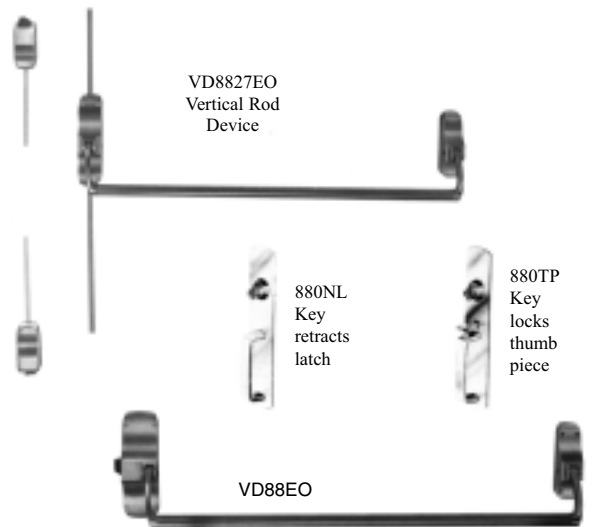

Guard-X

Provides secure, alarmed code-compliant protection for secondary exits. Guard-X exit alarm lock readily identifies the door on which it is mounted as an emergency exit and secures the opening against unauthorized use.

Mfg#	Desc	EZ #
VD2670US28	Guard-X alarm	071159
VD210DT050140SP28	Dummy pull trim	071160
VDSNB325	Sex nuts & bolts	071161
VD050379	Tailpiece	084003

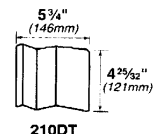

98/99 SERIES

- Exclusive sound dampening features • Non handed • Field sizeable
- 3/4" throw deadlocking latch bolt
- Hex key dogging • Length: 36" (for door sizes 2'6" - 3'0")

Mfg. #	Fin.	Description	EZ #
Smooth Mechanism Case			
VD98EO 26D	26D	Exit only	028967
Grooved Mechanism Case			
VD99EO28	628	Exit only	029829
VD99EO313AN	313	Exit only	062624
VD99EO26D	626	Exit only	065626
VD99EO F26D	626	Fire rated exit only	061397
VD99EO FSP313	313	Fire rated exit only	066366
VD99EO 26D4FT	26D	Exit only 48"	079237
VD99EO628 4FT	628	Exit only 48"	062887
VD99EO48 313AN	313	Exit only 48"	069549
VDCX99EO26D 3FT	26D	Chexit (delayed exit)	079335
Surface Mounted Vertical Rod			
VD9927EO28	628	Exit only	062623
VD9927EO626	626	Exit only	029828
VD9927EO313	313	Exit only	065220
VD9927EO 26D4FT	26D	Exit only 48"	079272
VD9927EO F26D4	26D	Fire exit hardware	079293
Exterior Trim Only			
VD990DT26D	626	Dummy trim	060527
VD990NL R26D	626	Night latch	028971
VD990TP R26D	626	Thumb piece	028973
*VD992L R26D RHR	626	Lever	042225
*VD992L R26D LHR	626	Lever	028972
VD996L 26D	626	Lever	083140

*Specify hand when ordering Devices are stocked for 3'0" door.

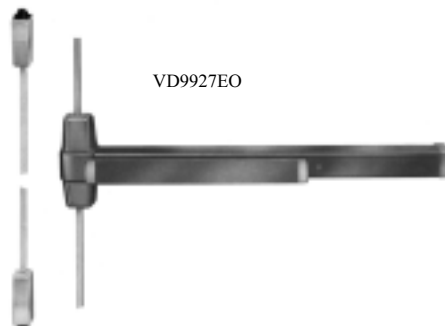
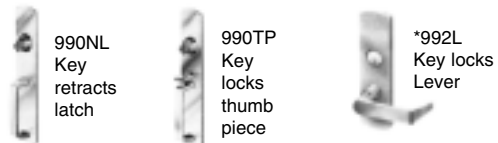

PARTS & ACCESSORIES

Mfg#	Description	EZ #
VD227	22/88/98/99 series 5/32" dogging key	013749
VD299 26D	Standard strike/ sgl door	013755
VDPS873 2	Power supply	070366
VDEPT1024SP28	Electric power transfer	030532
VD050070	EL electric latch retraction kit 3'	068217
VD050078	EL electric latch retraction kit 4'	084404
VD050014 26D	98/99 series impact resistant end cap	076138
VD050237 12VDC	Solenoid kit	030167
VD99ALK28	Alarm kit for 99 exit device	069014
VD050534	Potted circuit breaker	070364
VD4954 SP28 7'2"	Mullion for 7'2" opening	075575
VDKR4954 SP28 7'6"	Key removable mullion for 7'6" open	068259
VD5100 689	12/24VDC Electric Strike	074901
VD6210 32D 24VDC	Strike Force Electric Strike	070367
VD6211 32D 24VDC	Electric Strike	030193
VD971440 89	1/4-20 Hex Stud	070677





Deadbolt Locks

NA Series Standard Duty Tubular Locksets

Locks are stocked with 2 3/8" / 2 1/2" adjustable latches

- 2 1/8" diameter bore
- Adjustable backset
- Automatic adjustment to door thickness of 1 3/8" to 1 3/4"
- 4 post construction, provides easy alignment for quick installation
- Stainless steel 5 coil spring, ensures long life, corrosion resistant. Lifetime mechanical warranty & Brilliance finish
- 500 Ent. = Push entire knob to lock, 530 Ent. = T-Turn to lock

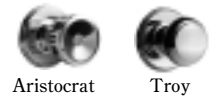

Mfg. #	Knob	Fin.	EZ #
<i>Passage Sets - Both knobs always free</i>			
WENA100A 5	Aristocrat	5	042230
WENA100A5VPM RLRS	Aristocrat	5	070139
WENA100B 3	Beverly	3	027633
WENA100B 26D	Beverly	26D	042238
WENA100B3VPM RLRS	Beverly	3	070136
WENA100B5VPM RLRS	Beverly	5	070137
WENA100H3VPM RLRS	Huntington	3	070142
WENA100T 3	Troy	3	042239

Privacy Locksets – Push and turn knob locking inside

WENA300A 5	Aristocrat	5	042242
WENA300A5VPM RLRS	Aristocrat	5	070140
WENA300B3VPM RLRS	Beverly	3	070134
WENA300B5VPM RLRS	Beverly	5	070135
WENA300B 26D	Beverly	26D	042244
WENA300B 3	Beverly	3	043095
WENA300H3VPM RLRS	Huntington	3	070141
WENA300T3RLRS	Troy	3	066296

Entrance Locksets – T-Turn locking inside

WENA530ADL5 K2	Aristocrat	5	042261
WENA530A3KA3VPM RLRS	Aristocrat	3	070138
WENA530B5KA3VPM RLRS	Beverly	5	070133
WENA530B3 KA4	Beverly	3	027639
WENA530B26DKA4	Beverly	26D	027640
WENA530B3KA3VPM RSRL	Beverly	3	070132
WENA530HDL3 K4	Huntington	3	042262
WENA530HDL5 K2	Huntington	5	042263
WENA530HDL26D K2	Huntington	26D	042264

Storeroom Locksets - outside always locked, inside always free

WENA580B3 KA4	Beverly	3	027641
WENA580B26D KA4	Beverly	26D	027642

VPM = Visual Pack RLRS = Round Corner Latch / Round Corner Strike

NA Series (cont)

Mfg. #	Knob	Fin.	EZ #
<i>Entrance Locksets – Push and turn knob locking</i>			
WENA500A5 K2	Aristocrat	5	042252
WENA500B3 KA4	Beverly	3	027635
WENA500B26D KA2	Beverly	26D	027637
WENA500B3KA3VPM RLRS	Beverly	3	065856
WENA500TDL 3K2	Troy	3	042254
WENA500TDL5K2	Troy	5	042255
WENA500H3KA3VPM RLRS	Huntington	3	065857

Crown Series Light Duty Tubular Locksets

- 2 1/8" diameter bore
- Door thickness of 1 3/8" to 1 3/4"
- Adjustable backset
- 24 / case



Richmond

Mfg. #	Fin.	Knob	EZ #
<i>Entrance Locksets - Push & Turn Knob Locking</i>			
WENAC500R5K4	5	Richmond	043096
WENAC500R3K4	3	Richmond	042256
<i>Passage Sets</i>			
WENAC100R3	3	Richmond	013989
<i>Privacy Sets</i>			
WENAC300R3	3	Richmond	013991

NDC9000L Crown Series Deadbolts

- 1 1/2" or 2 1/8" diameter bore, adjustable backset
- Door thickness of 1 1/8" to 1 3/4"
- 1" projection deadbolt latch
- T-turn deadbolts meet ADA



NDC9470L

Mfg. #	Fin.	EZ #
<i>Single Cylinder</i>		
WENDC9470L3K4	3	013998
WENDC9470L5	5	013999
WENDC9470L26D KA6	26D	028226
<i>Double Cylinder</i>		
WENDC9370L3	3	013996
WENDC9370L5	5	013997
WENDC9370L26D KA6	26D	028225



NDC9370L

Solid Forged Brass Entrance Handlesets

- Upper deadbolt section: 1 1/2" to 2 1/8" diameter bore
- Lower handle section: 2 1/8" diameter bore
- Automatic adjustment to door thickness 1 3/8" to 1 3/4"
- Adjustable backset

Mfg. #	Fin.	Handlesets	Inside	EZ #
WENA630FNBSB5	5	Fashion	Beverly	042253
<i>Double Cylinder</i>				
WENA9370HPB3	3	High Point	Beverly	042274
<i>Single Cylinder</i>				
WENA9470AB3	3	Augusta	Beverly	027643
WENA9470AUG H3VP	3	Augusta	Huntington	065869
WENA9470CMB H3VP	3	Colonial	Huntington	065864
WENA9470HPA5	5	High Point	Aristocrat	027645
WENA9470HPB3	3	High Point	Beverly	029280

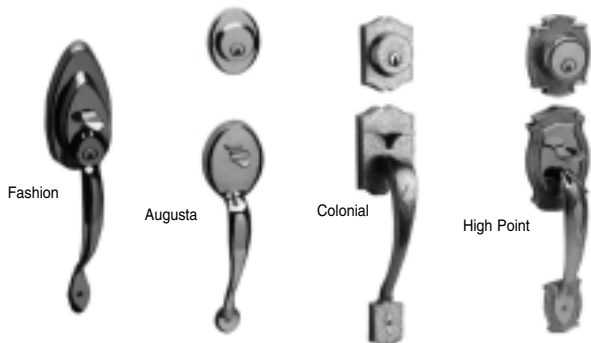

Powerbolt Home Access System

Easy To Install: Easily replaces existing door hardware. No wiring necessary (add 4 standard "AA" batteries).

Easy To Program: Choose any 4-8 digit personal security code. Set a code easily from inside the home.

Easy To Use: To lock, press button touchpad; to unlock enter your personalized security code

Single cylinder deadbolt, adj. backset

Mfg. #	Fin.	EZ #
<i>Touchpad Electronic Deadbolt</i>		
WEED1460 3	3	069356
WEED1460 5	5	069357
WEED1460 26D	26D	069950



ND9000 Series

- 1 1/2" to 2 1/8" diameter bore
- Meets or exceeds all requirements of ANSI A156.5, Grade 2
- Adjustable backset bolts are standard
- Automatic adjustment to door thickness of 1 3/8" to 1 3/4"
- 1" projection deadbolt latch
- T-Turn deadbolts meet ADA



ND9370X



ND9470X

Mfg. #	Fin.	EZ #
<i>Single Cylinder</i>		
WEND9470X3KA2	3	027652
WEND9470X3KAVPM RLRS	3	065863
WEND9470X5KA2	5	027653
WEND9470X26D KA2	26D	027654
WEND9470X5KA3VPM RLRS	5	070131
<i>Double Cylinder</i>		
WEND9370X3KA2	3	027649
WEND9370X3KA3VPM RLRS	3	065862
WEND9370X5KA2	5	027650
WEND9370X26D KA3	26D	027651
WEND9370X5KA3VPM RLRS	5	070130

VPM = Visual Pack

RLRS = Round Corner Latch / Round Corner Strike

Replacement Parts and Accessories

Mfg. #	Description	EZ #
WEA01133	Lock Unit for A630	013868
WEA50469D4	Adj. RF Deadlatch	042283
WEA52460D26D	Adj. Deadlatch	042286
WEA52460D4	Adj. Deadlatch	027662
WEA52460 4	Adj. Spring Latch	042287
WEA52460 26D	Adj. Spring Latch	042288
WEA74460W4	Adj. Backset Deadbolt	042290
WEA74460W26D	Adj. Backset Deadbolt	042291
WEA76469	Adj. Drive In	042292
WEA8350	T/P Assembly Sgl. Cyl.	013866
WEA3016995	Tailpiece Dbl Cylinder	042279
WE1029	3-way Cylinder Cap Tool	014005
WE1421	Plug Follower	014011
WE1418	Keying Kit	014008
WE1555NS	Original Key Blank - 5 pin	014017



5400 Series Heavy Duty Locks Grade 1

Meets ANSI Specs; A156.2 Series 4000, Grade 1
 Mechanism: Heavy-gauge cold rolled steel
 Backset: 2 3/4" standard, 1/2" throw
 Reversibility: Field reversible
 Finish: All locks are stocked in 26D finish

Mfg. #	Design	EZ #
<i>Storeroom Lock</i>		
YALF5405 26D	Litchfield	014356
<i>Entrance</i>		
YALF5407 26D	Litchfield	014358
<i>Classroom Lock</i>		
YALF5408 26D	Litchfield	014359

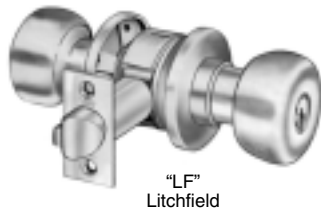

5300 Series Standard Duty Locks Grade 2

Mechanism: Heavy-gauge cold rolled steel
 Reversibility: Locksets are field reversible.

Mfg. #	Fin.	Backset	Knob	EZ #
<i>Storeroom Lock</i>				
YACA5305 26D 2 3/4	26D	2 3/4"	Carolina	040386
YALF5305 2 3/8 3	3	2 3/8"	Litchfield	026320
YALF5305 2 3/4 26D	26D	2 3/4"	Litchfield	026321
<i>Entrance Lock</i>				
YACA5307 2 3/4 26D	26D	2 3/4"	Carolina	026323
YALF5307 3 2 3/4	3	2 3/4"	Litchfield	014352
YALF5307 26D 2 3/4	26D	2 3/4"	Litchfield	014349
<i>Classroom Lock</i>				
YACA5308 26D	26D	2 3/8"	Carolina	044438
YALF5308 26D 2 3/4	26D	2 3/4"	Litchfield	040389



Rim Locks

#88 Pin Tumbler Latchlock

5/8" throw; 2 3/8" b.s. 2 3/4"H x 3 5/8"W

YA88 EZ # 040360



#80 Pin Tumbler Latchlock

1/2" throw; 2 3/8" b.s. 2 5/8"H x 3 5/8"W

YA80 EZ # 026276



#112 Pin Tumbler Boltlock

1 1/8" throw; 2 3/8" b.s. 3 3/8"H x 3 1/2"W

112 Single Cylinder

YA112 EZ # 014413

112F Single Cylinder with flat strike

YA112F EZ # 014416

112 - 1/4 Double Cyl.

YA112 1/4 EZ # 014414



#197 Pin Tumbler Jimmyproof

2 3/8" b.s. 3 1/8"H x 4 3/4"W

197 Single Cylinder

YA197 EZ # 014438

197F Single Cylinder with Flat Strike

YA197F EZ # 014441

197 - 1/4 Double Cyl.

YA197 1/4 EZ # 014439



50 Series Door Closers

- ANSI Grade 1, U.L. Listed
- Closer Sizes 3 and 4, adjustable backcheck cushioning
- 50 Series - Highly corrosion resistant
- Installs Regular Arm, Parallel Arm or Top Jamb
- No cover - 2 7/8" projection
- Non-handed
- 10 year warranty.

Mfg. # EZ #

YA53BC SB TBGN 040362

YA54BC SB TBGN 040363

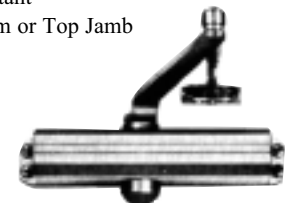

SB - Sprayed Aluminum **TBGN** - Thru Bolts / Grommet Nuts

Replacement Deadlatches

Mfg. # B.S. Fin. EZ #

5300 Series Grade 2

YA380AN3 2 3/4" US3 014451

YA380AN26D 2 3/4" 26D 014450

YA380N3 2 3/8" US3 014452

YA380N26D 2 3/8" 26D 026280

5400 Series Grade 1

YA494 26D 2 3/4" 26D 040367



Mortise Cylinders

Mfg. #	Kwy.	Fin.	EZ #
--------	------	------	------

1152 1 1/8" Cylinder

YA1152 1 1/8 3	8	3	014427
YA1152 1 1/8 GA 3	GA	3	040372
YA1152 1 1/8 GA 10B	GA	10B	040378
YA1152 1 1/8 GA 26D	GA	26D	014420
YA1152 1 1/8 GB 3	GB	3	040374
YA1152 1 1/8 GB 26D	GB	26D	014421



1152 1 1/4" Cylinder

YA1152 1 1/4 3	8	3	014426
YA1152 1 1/4 26D	8	26D	014419
YA1152 1 1/4 GA 3	GA	3	040373
YA1152 1 1/4 GA 26D	GA	26D	040380

Mfg. #	Kwy.	Fin.	EZ #
--------	------	------	------

1152 Plugs Only for Mortise Cyl.

YA1152PLUG GA 26D	1 1/8" GA	26D	040375
YA1152PLUG GB 26D	1 1/8" GB	26D	040376
YA1152PLUG GC 26D	1 1/8" GC	26D	040377
YA1152PLUG GC 26D	1 1/4" GC	26D	043149

Rim Cylinders

Mfg. #	Kwy.	Fin.	EZ #
--------	------	------	------

1109 6 Pin Cylinder

YA1109 3KD6PIN	8	3	026289
YA1109 26D6PIN	8	26D	014406

Mfg. #	EZ #
--------	------

Rim Cylinder Tailpiece

YA1147	014417
YA1145 (long)	040371



Mfg. #	EZ #
--------	------

1109 Plug, 6 Pin for Rim Cyl.

YA1109PLUG GA26D	026285
YA1109PLUG GB26D	040368
YA1109PLUG GC26D	073796

Replacement Cylinders for 5300/5400 Series

Mfg. #	Kwy.	Fin.	EZ #
--------	------	------	------

1801 Replacement Cylinder for Knoblocks

YA1801GA 26D	GA	26D	026309
YA1801 8 26D	8	26D	040384

1801 Plug Only for Knob Cyl.

YA1801PLUG GA3	GA	3	014274
YA1801PLUG GA26D	GA	26D	026303
YA1801PLUG GB26D	GB	26D	026304
YA1801PLUG GC26D	GC	26D	040381
YA1801PLUG GD26D	GD	26D	040383



Mortise Cylinder Cam for Adams Rite

Mfg. #	EZ #
--------	------

YA1161L	014430
---------	--------



Key Blanks

Mfg. #	Kwy.	EZ #
--------	------	------

YABR8	5 pin brass	014457
YARN8	5 pin nickel silver	014398
YARN8GA	5 pin nickel silver	014399
YARN8GB	5 pin nickel silver	014400
YARN8GC	5 pin nickel silver	014401
YARN8GMK	5 pin nickel silver	014402
YARN9	4 pin nickel silver	014459
YARN10	4 pin nickel silver	014366
YARN10JA	4 pin nickel silver	014367
YAX10 1/2	4 pin nickel silver	040396
YARN11	6 pin nickel silver	014369
YARN11GA	6 pin nickel silver	014370
YARN11GB	6 pin nickel silver	014371
YARN11GC	6 pin nickel silver	014372
YARN11GD	6 pin nickel silver	014373
YARN11GE	6 pin nickel silver	014374
YARN11GF	6 pin nickel silver	014375
YARN11GG	6 pin nickel silver	014376
YARN11GH	6 pin nickel silver	014377
YARN11GK	6 pin nickel silver	014378
YARN11GL	6 pin nickel silver	062027
YARN11GMK	6 pin nickel silver	014379
YARN11GST	6 pin nickel silver	028438
YARN11SA	6 pin nickel silver	014380
YARN11SB	6 pin nickel silver	014381
YARN11SC	6 pin nickel silver	014382
YARN11SD	6 pin nickel silver	014383
YARN11SE	6 pin nickel silver	014384
YARN11SF	6 pin nickel silver	014385
YARN11SG	6 pin nickel silver	014386
YARN11SH	6 pin nickel silver	014387
YARN11SMK	6 pin nickel silver	014388
YARN11TA	6 pin nickel silver	014389
YARN11TB	6 pin nickel silver	014390
YARN11TC	6 pin nickel silver	014391
YARN11TE	6 pin nickel silver	040397
YARN11TMK	6 pin nickel silver	014392
YARN12JMK	6 pin nickel silver	026328
YARN13JMK	5 pin nickel silver	026329
YARN19	3 pin nickel silver	014437
YA9278RB1019B10R	Disc tumbler blank	026333

